

TL601, TL604, TL607, TL610 P-MOS ANALOG SWITCHES

SLAS042 – D2161, JUNE 1976 — REVISED OCTOBER 1986

- Switch ± 10 -V Analog Signals
- TTL Logic Capability
- 5-to 30-V Supply Ranges
- Low (100Ω) On-State Resistance
- High ($10^{11} \Omega$) Off-State Resistance
- 8-Pin Functions

description

The TL601, TL604, TL607, and TL610 are a family of monolithic P-MOS analog switches that provide fast switching speeds with high r_{off}/r_{on} ratio and no offset voltage. The p-channel enhancement-type MOS switches accept analog signals up to ± 10 V and are controlled by TTL-compatible logic inputs. The monolithic structure is made possible by BI-MOS technology, which combines p-channel MOS with standard bipolar transistors.

These switches are particularly useful in military, industrial, and commercial applications such as data acquisition, multiplexers, A/D and D/A converters, MODEMS, sample-and-hold systems, signal multiplexing, integrators, programmable operational amplifiers, programmable voltage regulators, crosspoint switching networks, logic interface, and many other analog systems.

The TL601 is an SPDT switch with two logic control inputs. The TL604 is a dual complementary SPST switch with a single control input. The TL607 is an SPDT switch with one logic control input and one enable input. The TL610 is an SPST switch with three logic control inputs. The TL610 features a higher r_{off}/r_{on} ratio than the other members of the family.

The TL601C, TL604C, TL607C, and TL610C are characterized for operation from 0°C to 70°C , the TL601I, TL604I, TL607I, and TL610I are characterized for operation from -25°C to 85°C , and the TL601M, TL604M, TL607M, and TL610M are characterized for operation over the full military temperature range of -55°C to 125°C .

JG OR P PACKAGE (TOP VIEW)

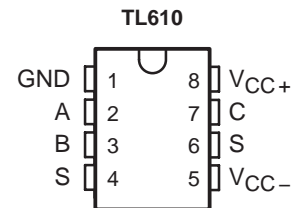
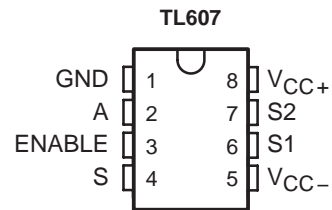
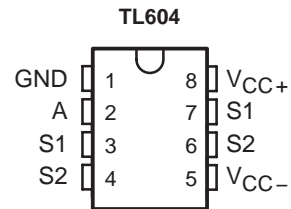
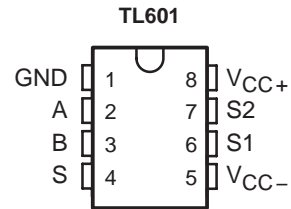

schematics of inputs and outputs

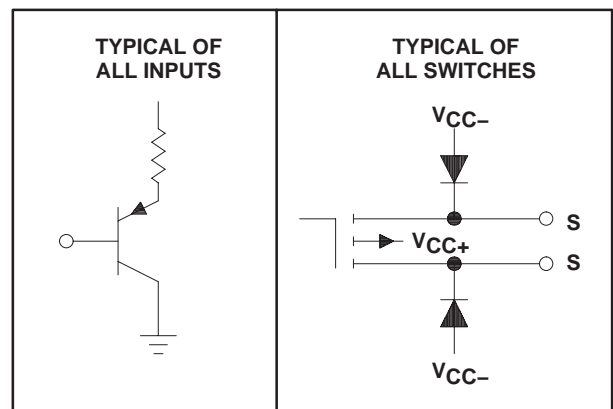

TL601, TL604, TL607, TL610 P-MOS ANALOG SWITCHES

D2161, JUNE 1976 — REVISED OCTOBER 1986

logic symbols† and switch diagrams

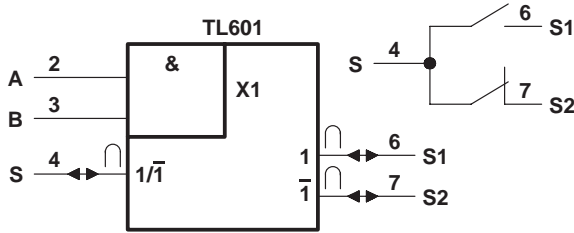

FUNCTION TABLE

INPUTS		ANALOG SWITCHES	
A	B	S1	S2
L	X	Off (open)	On (closed)
X	L	Off (open)	On (closed)
H	H	On (closed)	Off (open)

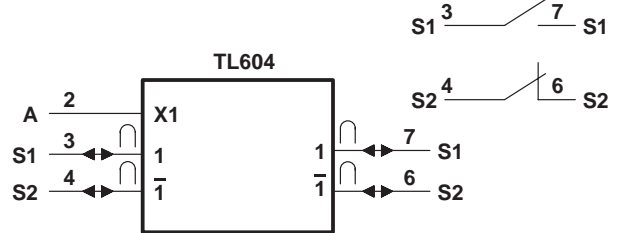

FUNCTION TABLE

INPUT	ANALOG SWITCHES	
A	S1	S2
H	On (closed)	Off (open)
L	Off (open)	On (closed)

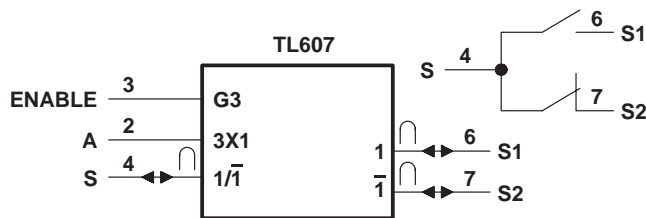

FUNCTION TABLE

INPUTS		ANALOG SWITCHES	
A	ENABLE	S1	S2
X	L	Off (open)	Off (open)
L	H	Off (open)	On (closed)
H	H	On (closed)	Off (open)

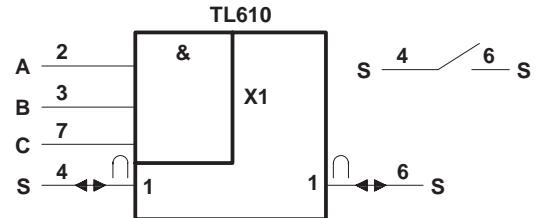

FUNCTION TABLE

INPUTS			ANALOG SWITCHES
A	B	C	S
L	X	X	Off (open)
X	L	X	Off (open)
X	X	L	Off (open)
X	H	H	On (closed)

† These symbols are in accordance with ANSI/IEEE Std 91-1984.

TL607 logic diagram (positive logic)

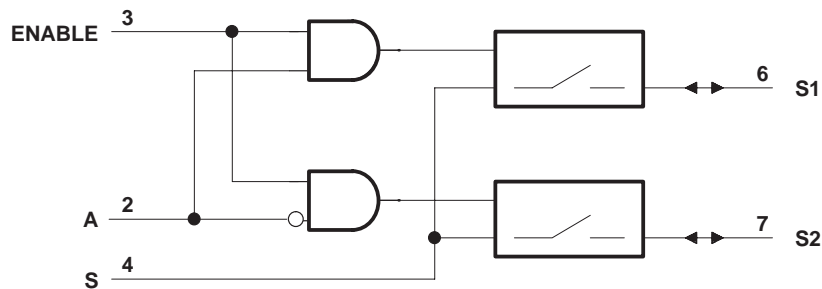

TL601, TL604, TL607, TL610 P-MOS ANALOG SWITCHES

D2161, JUNE 1976 — REVISED OCTOBER 1986

absolute maximum ratings over operating free-air temperature range (unless otherwise noted)

Supply voltage, V_{CC+} (see Note 1)	30 V
Supply voltage, V_{CC-}	-30 V
V_{CC+} to V_{CC-} supply voltage differential	35 V
Control input voltage	V_{CC+}
Switch off-state voltage	30 V
Switch on-state current	10 mA
Operating free-air temperature range:	
TL601C, TL604C, TL607C, TL610C	0°C to 70°C
TL601I, TL604I, TL607I, TL610I	-25°C to 85°C
TL601M, TL604M, TL607M, TL610M	-55°C to 125°C
Storage temperature range	-65°C to 150°C
Lead temperature (1,6 mm) 1/16 inch from case for 60 seconds: JG package	300°C
Lead temperature (1,6 mm) 1/16 inch from case for 10 seconds: P package	260°C

NOTE 1: All voltage values are with respect to network ground terminal.

recommended operating conditions

	TL601C, TL604C TL607C, TL610C			TL601I, TL604I TL607I, TL610I			TL601M, TL604M TL607M, TL610M			UNIT
	MIN	TYP	MAX	MIN	TYP	MAX	MIN	TYP	MAX	
Supply voltage, V_{CC+} (see Figure 1)	5	10	25	5	10	25	5	10	25	V
Supply voltage, V_{CC-} (see Figure 1)	-5	-20	-25	-5	-20	-25	-5	-20	-25	V
V_{CC+} to V_{CC-} supply voltage differential (see Figure 1)	15		30	15		30	15		30	V
High-level control input voltage, V_{IH}	2		5.5	2		5.5	2		5.5	V
Low-level control input voltage, V_{IL}	All inputs			0.8			0.8			
Voltage at any analog switch (S) terminal	$V_{CC-} + 8$		V_{CC+}	$V_{CC-} + 8$		V_{CC+}	$V_{CC-} + 8$		V_{CC+}	V
Switch on-state current	10			10			10			mA
Operating free-air temperature, T_A	0		70	25		85	-55		125	°C



TL601, TL604, TL607, TL610 P-MOS ANALOG SWITCHES

D2161, JUNE 1976 — REVISED OCTOBER 1986

electrical characteristics over recommended operating free-air temperature range, $V_{CC+} = 10\text{ V}$, $V_{CC-} = -20\text{ V}$, analog switch test current = 1 mA (unless otherwise noted)

PARAMETER	TEST CONDITIONS†	TL6 __ C			TL6 __ M TL6 __ I			UNIT		
		MIN	TYP‡	MAX	MIN	TYP‡	MAX			
I_{IH} High-level input current	$V_I = 5.5\text{ V}$		0.5	10		0.5	10	μA		
I_{IL} Low-level input current	$V_I = 0.4\text{ V}$		-50	-250		-50	-250	μA		
I_{off} Switch off-state current	$V_{I(sw)} = -10\text{ V}$, See Note 2	$T_A = 25^\circ\text{C}$		-500		-400		pA		
		$T_A = \text{MAX}^\dagger$		-10	-20		-50	-100	nA	
r_{on} Switch on-state resistance	$V_{I(sw)} = 10\text{ V}$, $I_{O(sw)} = -1\text{ mA}$	TL601 TL604 TL607		75	200		55	100	Ω	
		TL610		40	100		40	80		
	$V_{I(sw)} = -10\text{ V}$, $I_{O(sw)} = -1\text{ mA}$	TL601 TL604 TL607		220	600		220	400		
		TL610		120	300		120	300		
r_{off} Switch off-state resistance			20		20		$\text{G}\Omega$			
C_{on} Switch on-state input capacitance	$V_{I(sw)} = 0\text{ V}$, $f = 1\text{ MHz}$		16		16		pF			
C_{off} Switch off-state input capacitance	$V_{I(sw)} = 0\text{ V}$, $f = 1\text{ MHz}$		8		8		pF			
I_{CC+} Supply current from V_{CC+}	Logic input(s) at 5.5 V, All switch terminals open	TL601 TL604		5	10		5	10	mA	
		TL607	ENABLE high		5	10		5		10
			ENABLE low		3	5		3		5
		TL610		5	10		5	10		
I_{CC-} Supply current from V_{CC-}	Logic input(s) at 5.5 V, All switch terminals open	TL601 TL604		-1.2	-2.5		-1.2	-2.5	mA	
		TL607	ENABLE high		-2.5	-5		-2.5		-5
			ENABLE low		-0.05	-0.5		-0.05		-0.5
		TL610		-1.2	-2.5		-1.2	-2.5		

† MAX is 70°C for C-suffix types, 85°C for I-suffix types, and 125°C for M-suffix types.

‡ All typical values are at $T_A = 25^\circ\text{C}$ except for I_{off} at $T_A = \text{MAX}$.

NOTE 2: The other terminal of the switch under test is at $V_{CC+} = 10\text{ V}$.

switching characteristics, $V_{CC+} = 10\text{ V}$, $V_{CC-} = -20\text{ V}$, $T_A = 25^\circ\text{C}$

PARAMETER	TEST CONDITIONS	MIN	TYP	MAX	UNIT
t_{off} Switch turn-off time	$R_L = 1\text{ k}\Omega$, $C_L = 35\text{ pF}$, See Figure 2		400	500	ns
t_{on} Switch turn-on time			100	150	



PARAMETER MEASUREMENT INFORMATION

Figure 1 shows power supply boundary conditions for proper operation of the TL601 Series. The range of operation for supply V_{CC+} from 5 V to 25 V is shown on the vertical axis. The range of V_{CC-} from -5 V to -25 V is shown on the horizontal axis. A recommended 30-V maximum voltage differential from V_{CC+} to V_{CC-} governs the maximum V_{CC+} for a chosen V_{CC-} (or vice versa). A minimum recommended difference of 15 V from V_{CC+} to V_{CC-} and the boundaries shown in Figure 1 allow the designer to select the proper combinations of the two supplies.

The designer-selected V_{CC+} supply value for a chosen V_{CC-} supply value limits the maximum input voltage that can be applied to either switch terminal; that is, the input voltage should be between $V_{CC-} + 8$ V and V_{CC+} to keep the on-state resistance within specified limits.

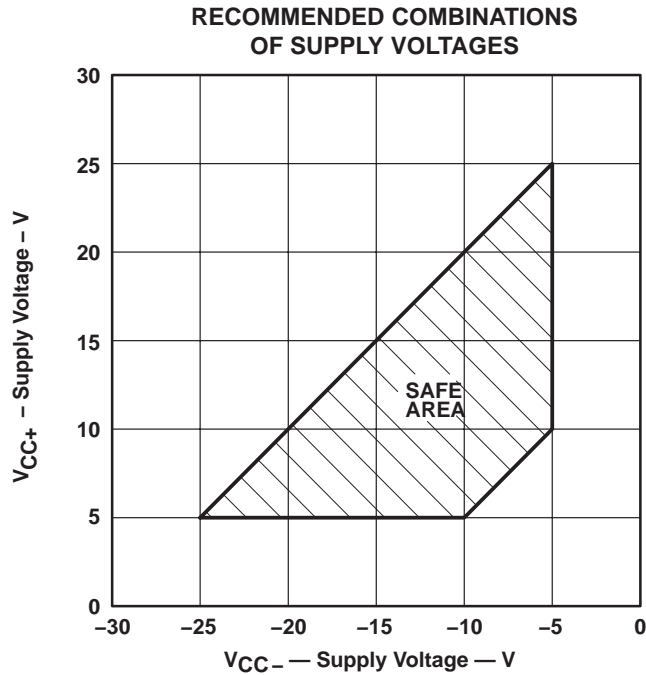
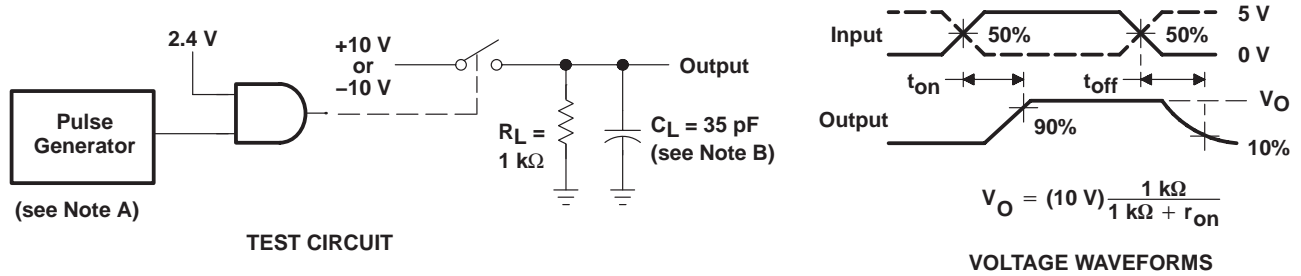

Figure 1

TL601, TL604, TL607, TL610 P-MOS ANALOG SWITCHES

D2161, JUNE 1976 — REVISED OCTOBER 1986

PARAMETER MEASUREMENT INFORMATION



NOTES: A. The pulse generator has the following characteristics: $Z_O = 50\ \Omega$, $t_r \geq 15\text{ ns}$, $t_f \geq 15\text{ ns}$, $t_w = 500\text{ ns}$.
B. C_L includes probe and jig capacitance.

Figure 2

TYPICAL CHARACTERISTICS

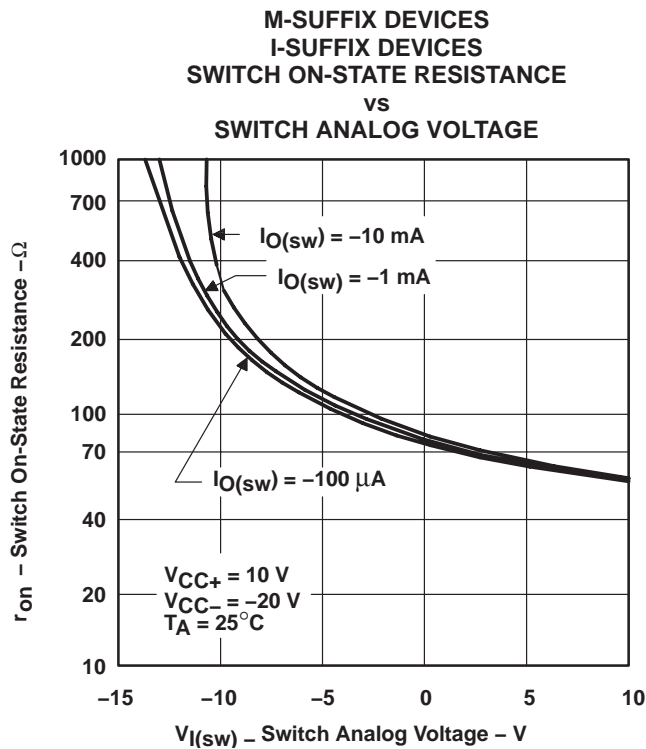

Figure 3

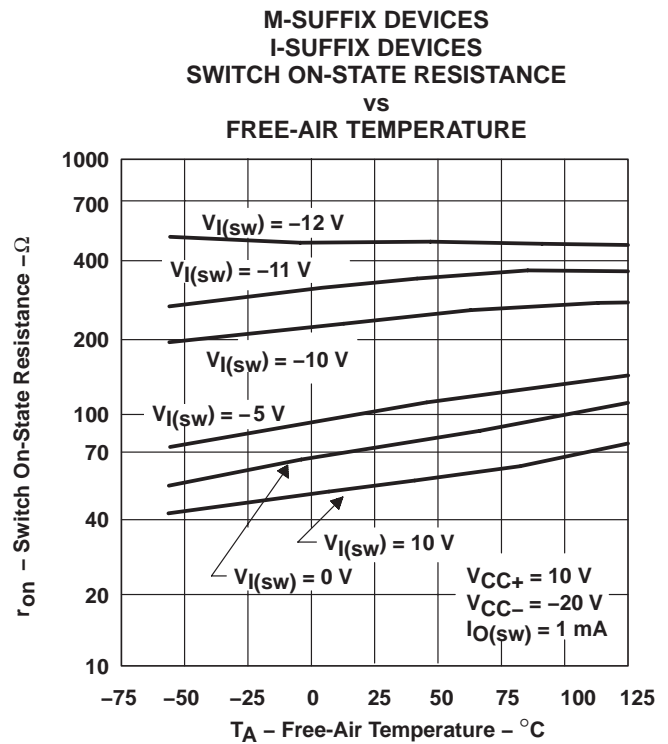

Figure 4

PACKAGING INFORMATION

Orderable Device	Status ⁽¹⁾	Package Type	Package Drawing	Pins	Package Qty	Eco Plan ⁽²⁾	Lead/Ball Finish	MSL Peak Temp ⁽³⁾
TL601CP	OBSOLETE	PDIP	P	8		TBD	Call TI	Call TI
TL601IP	OBSOLETE	PDIP	P	8		TBD	Call TI	Call TI
TL604CP	OBSOLETE	PDIP	P	8		TBD	Call TI	Call TI
TL607CP	OBSOLETE	PDIP	P	8		TBD	Call TI	Call TI
TL610CP	OBSOLETE	PDIP	P	8		TBD	Call TI	Call TI

⁽¹⁾ The marketing status values are defined as follows:

ACTIVE: Product device recommended for new designs.

LIFEBUY: TI has announced that the device will be discontinued, and a lifetime-buy period is in effect.

NRND: Not recommended for new designs. Device is in production to support existing customers, but TI does not recommend using this part in a new design.

PREVIEW: Device has been announced but is not in production. Samples may or may not be available.

OBSOLETE: TI has discontinued the production of the device.

⁽²⁾ Eco Plan - The planned eco-friendly classification: Pb-Free (RoHS) or Green (RoHS & no Sb/Br) - please check <http://www.ti.com/productcontent> for the latest availability information and additional product content details.

TBD: The Pb-Free/Green conversion plan has not been defined.

Pb-Free (RoHS): TI's terms "Lead-Free" or "Pb-Free" mean semiconductor products that are compatible with the current RoHS requirements for all 6 substances, including the requirement that lead not exceed 0.1% by weight in homogeneous materials. Where designed to be soldered at high temperatures, TI Pb-Free products are suitable for use in specified lead-free processes.

Green (RoHS & no Sb/Br): TI defines "Green" to mean Pb-Free (RoHS compatible), and free of Bromine (Br) and Antimony (Sb) based flame retardants (Br or Sb do not exceed 0.1% by weight in homogeneous material)

⁽³⁾ MSL, Peak Temp. -- The Moisture Sensitivity Level rating according to the JEDEC industry standard classifications, and peak solder temperature.

Important Information and Disclaimer:The information provided on this page represents TI's knowledge and belief as of the date that it is provided. TI bases its knowledge and belief on information provided by third parties, and makes no representation or warranty as to the accuracy of such information. Efforts are underway to better integrate information from third parties. TI has taken and continues to take reasonable steps to provide representative and accurate information but may not have conducted destructive testing or chemical analysis on incoming materials and chemicals. TI and TI suppliers consider certain information to be proprietary, and thus CAS numbers and other limited information may not be available for release.

In no event shall TI's liability arising out of such information exceed the total purchase price of the TI part(s) at issue in this document sold by TI to Customer on an annual basis.

P (R-PDIP-T8)

PLASTIC DUAL-IN-LINE PACKAGE



- NOTES:
- A. All linear dimensions are in inches (millimeters).
 - B. This drawing is subject to change without notice.
 - C. Falls within JEDEC MS-001 variation BA.

IMPORTANT NOTICE

Texas Instruments Incorporated and its subsidiaries (TI) reserve the right to make corrections, enhancements, improvements and other changes to its semiconductor products and services per JESD46, latest issue, and to discontinue any product or service per JESD48, latest issue. Buyers should obtain the latest relevant information before placing orders and should verify that such information is current and complete. All semiconductor products (also referred to herein as "components") are sold subject to TI's terms and conditions of sale supplied at the time of order acknowledgment.

TI warrants performance of its components to the specifications applicable at the time of sale, in accordance with the warranty in TI's terms and conditions of sale of semiconductor products. Testing and other quality control techniques are used to the extent TI deems necessary to support this warranty. Except where mandated by applicable law, testing of all parameters of each component is not necessarily performed.

TI assumes no liability for applications assistance or the design of Buyers' products. Buyers are responsible for their products and applications using TI components. To minimize the risks associated with Buyers' products and applications, Buyers should provide adequate design and operating safeguards.

TI does not warrant or represent that any license, either express or implied, is granted under any patent right, copyright, mask work right, or other intellectual property right relating to any combination, machine, or process in which TI components or services are used. Information published by TI regarding third-party products or services does not constitute a license to use such products or services or a warranty or endorsement thereof. Use of such information may require a license from a third party under the patents or other intellectual property of the third party, or a license from TI under the patents or other intellectual property of TI.

Reproduction of significant portions of TI information in TI data books or data sheets is permissible only if reproduction is without alteration and is accompanied by all associated warranties, conditions, limitations, and notices. TI is not responsible or liable for such altered documentation. Information of third parties may be subject to additional restrictions.

Resale of TI components or services with statements different from or beyond the parameters stated by TI for that component or service voids all express and any implied warranties for the associated TI component or service and is an unfair and deceptive business practice. TI is not responsible or liable for any such statements.

Buyer acknowledges and agrees that it is solely responsible for compliance with all legal, regulatory and safety-related requirements concerning its products, and any use of TI components in its applications, notwithstanding any applications-related information or support that may be provided by TI. Buyer represents and agrees that it has all the necessary expertise to create and implement safeguards which anticipate dangerous consequences of failures, monitor failures and their consequences, lessen the likelihood of failures that might cause harm and take appropriate remedial actions. Buyer will fully indemnify TI and its representatives against any damages arising out of the use of any TI components in safety-critical applications.

In some cases, TI components may be promoted specifically to facilitate safety-related applications. With such components, TI's goal is to help enable customers to design and create their own end-product solutions that meet applicable functional safety standards and requirements. Nonetheless, such components are subject to these terms.

No TI components are authorized for use in FDA Class III (or similar life-critical medical equipment) unless authorized officers of the parties have executed a special agreement specifically governing such use.

Only those TI components which TI has specifically designated as military grade or "enhanced plastic" are designed and intended for use in military/aerospace applications or environments. Buyer acknowledges and agrees that any military or aerospace use of TI components which have **not** been so designated is solely at the Buyer's risk, and that Buyer is solely responsible for compliance with all legal and regulatory requirements in connection with such use.

TI has specifically designated certain components as meeting ISO/TS16949 requirements, mainly for automotive use. In any case of use of non-designated products, TI will not be responsible for any failure to meet ISO/TS16949.

Products

Audio	www.ti.com/audio
Amplifiers	amplifier.ti.com
Data Converters	dataconverter.ti.com
DLP® Products	www.dlp.com
DSP	dsp.ti.com
Clocks and Timers	www.ti.com/clocks
Interface	interface.ti.com
Logic	logic.ti.com
Power Mgmt	power.ti.com
Microcontrollers	microcontroller.ti.com
RFID	www.ti-rfid.com
OMAP Applications Processors	www.ti.com/omap
Wireless Connectivity	www.ti.com/wirelessconnectivity

Applications

Automotive and Transportation	www.ti.com/automotive
Communications and Telecom	www.ti.com/communications
Computers and Peripherals	www.ti.com/computers
Consumer Electronics	www.ti.com/consumer-apps
Energy and Lighting	www.ti.com/energy
Industrial	www.ti.com/industrial
Medical	www.ti.com/medical
Security	www.ti.com/security
Space, Avionics and Defense	www.ti.com/space-avionics-defense
Video and Imaging	www.ti.com/video

TI E2E Community

e2e.ti.com