

## Low-cost Digital Bipolar Hall-effect Sensor ICs, SS41F, SS41G

**32312814**  
Issue A

Datasheet

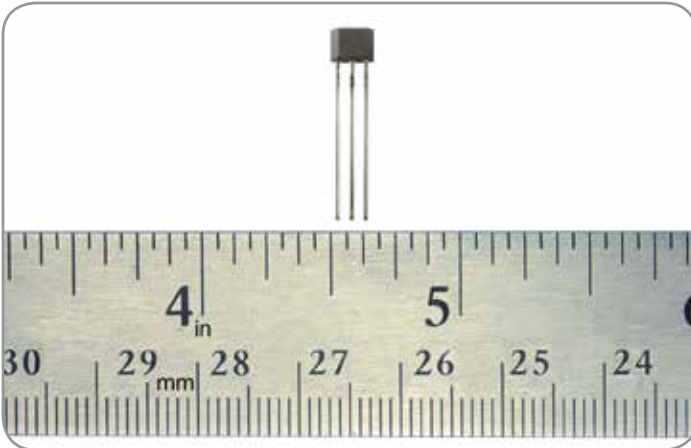

### DESCRIPTION

The SS41F and SS41G are small, versatile digital Hall-effect devices that are operated by the magnetic field from a permanent magnet or an electromagnet, and are designed to respond to alternating North and South poles.

A built-in regulator provides enhanced stability of operation over 4.5 Vdc to 24 Vdc supply voltage range, and internal circuitry is designed to prevent sensor damage in case the supply voltage polarity is accidentally reversed.

The open-collector sinking output voltage is easily interfaced with a wide variety of electronic circuits.

The SS41F is factory tested at 25 °C [77 °F] and the SS41G is factory tested at both 25 °C [77 °F] and 125 °C [257 °F].

Both products are designed for high volume applications.

These products are available in one package style:

- **SS41F, SS41G:** Flat TO-92-style package with straight leads in bulk packaging which allows for a compact PC board layout

### FEATURES

- Small, leaded, flat TO-92-style package allows for a compact PCB layout
- Wide operating voltage range of 4.5 Vdc to 24 Vdc allows these sensors to be used in a variety of applications
- Current consumption of only 5 mA max. at 4.5 Vdc for energy efficiency
- Bipolar magnetics for ring magnet applications with alternating North and South poles
- Robust design: Will operate up to 150 °C [302 °F]
- RoHS-compliant materials meet Directive 2002/95/EC

### POTENTIAL APPLICATIONS

#### Transportation

- Speed and RPM sensing
- Commutation and control of electric motors used in transportation

#### Industrial and Commercial

- Flow-rate sensing for appliances
- Tachometer counter pickup
- Brushless dc motor commutation
- Motor and fan control for commercial, consumer or industrial equipment

#### Medical

- Any medical equipment or instruments using electric motors

### PORTFOLIO

The SS41F, SS41G are part of Honeywell's family of low-cost digital bipolar Hall-effect sensor ICs, including:

- [SS30AT, SS40A, SS50AT](#)
- [SS311PT, SS411P](#)
- [SS411A, SS413A](#)
- [SS51T, SS511AT, SS513AT](#)

# Low-cost Digital Bipolar Hall-effect Sensor ICs, SS41F, SS41G

**Table 1. SS41F Electrical and Environmental Specifications**

(At  $V_{\text{supply}} = 4.5 \text{ Vdc}$  to  $24.0 \text{ Vdc}$ ,  $20 \text{ mA}$  load,  $T_A = 25 \text{ }^\circ\text{C}$  [77 °F] except where otherwise specified.)

Characteristic	Condition	Min.	Typ.	Max.	Unit
Supply voltage	—	4.5	—	24.0	Vdc
Supply current	—	—	6.8	10.0	mA
Output current	—	—	—	20.0	mA
$V_{\text{sat}}$ at 15 mA	$V_{\text{supply}} = 12 \text{ Vdc}$ , $B_{\text{op}} > 170$	—	—	0.4	V
Output leakage current	$V_{\text{supply}} = 24 \text{ Vdc}$ , $B_{\text{rp}} \leq -170$	—	—	10.0	uA
Rise time	$V_{\text{supply}} = 4.5 \text{ Vdc}$	—	0.5	1.5	us
Fall time	$V_{\text{supply}} = 4.5 \text{ Vdc}$	—	0.2	1.5	us
Magnetic characteristics: operate (Bop) release (Brp) differential	— — —	— -150 40	40 -40 —	150 — —	Gauss
Operating temperature	—	-40 [-40]	—	150 [302]	°C [°F]
Storage temperature	—	-40 [-40]	—	150 [302]	°C [°F]
ESD (Human Body Model)	per JEDEC JS-001	-3	—	+3	kV
Soldering temperature and time	PC board wave soldering process: 250 °C to 260 °C [482 °F to 500 °F] for 3 s max.				

**Table 2. SS41G Electrical and Environmental Specifications**

(At  $V_{\text{supply}} = 4.5 \text{ Vdc}$  to  $24.0 \text{ Vdc}$ ,  $20 \text{ mA}$  load,  $T_A = -40 \text{ }^\circ\text{C}$  to  $150 \text{ }^\circ\text{C}$  [-40 °F to 302 °F] except where otherwise specified.)

Characteristic	Condition	Min.	Typ.	Max.	Unit
Supply voltage	—	4.5	—	24.0	Vdc
Supply current: output off output on	— —	— —	6.8 —	10.0 11.3	mA
Output current	—	—	—	20.0	mA
$V_{\text{sat}}$ at 20 mA	$V_{\text{supply}} = 12.0 \text{ Vdc}$ , $B_{\text{rp}} \geq 170$ , $25 \text{ }^\circ\text{C}$ [77 °F]	—	—	0.4	V
Output leakage current	$V_{\text{supply}} = 24.0 \text{ Vdc}$ , $B_{\text{rp}} \leq -170$	—	—	10.0	μA
Rise time	25 °C [77 °F]	—	0.5	1.5	μs
Fall time	25 °C [77 °F]	—	0.2	1.5	μs
Magnetic characteristics: operate (Bop) operate (Bop) release (Brp) release (Brp) differential	25 °C [77 °F] — 25 °C [77 °F] — —	— — -140 -250 40	40 — -40 — —	150 250 — — —	Gauss
Operating temperature	—	-40 [-40]	—	150 [302]	°C [°F]
Storage temperature	—	-40 [-40]	—	150 [302]	°C [°F]
ESD (Human Body Model)	per JEDEC JS-001	-3	—	+3	kV
Soldering temperature and time	PC board wave soldering process: 250 °C to 260 °C [482 °F to 500 °F] for 3 s max.				

## NOTICE

These Hall-effect sensor ICs may have an initial output in either the ON or OFF state if powered up with an applied magnetic field in the differential zone (applied magnetic field  $> B_{\text{rp}}$  and  $< B_{\text{op}}$ ). Honeywell recommends allowing 10 μs after supply voltage has reached 3 V for the output voltage to stabilize.

## NOTICE

The magnetic field strength (Gauss) required to cause the switch to change state (operate and release) will be as specified in the magnetic characteristics. To test the switch against the specified limits, the switch must be placed in a uniform magnetic field.



**CAUTION**  
ELECTROSTATIC  
SENSITIVE  
DEVICES

DO NOT OPEN OR HANDLE  
EXCEPT AT A  
STATIC FREE WORKSTATION



**ESD SENSITIVITY:  
CLASS 2**

# Low-cost Digital Bipolar Hall-effect Sensor ICs, SS41F, SS41G

Table 3. SS41F, SS41G Absolute Maximum Specifications

Characteristic	Min.	Typ.	Max.	Unit
Supply voltage	-50.0	—	50.0	V
Applied output voltage	-0.5	—	50.0	V
Output current	—	—	20	mA
Magnetic flux	—	—	no limit	Gauss

## NOTICE

Absolute maximum ratings are the extreme limits the device will momentarily withstand without damage to the device. Electrical and mechanical characteristics are not guaranteed if the rated voltage and/or currents are exceeded, nor will the device necessarily operate at absolute maximum ratings.

Figure 1. Magnetic Performance vs Temperature ( $V_{supply} = 12 \text{ Vdc}$ )

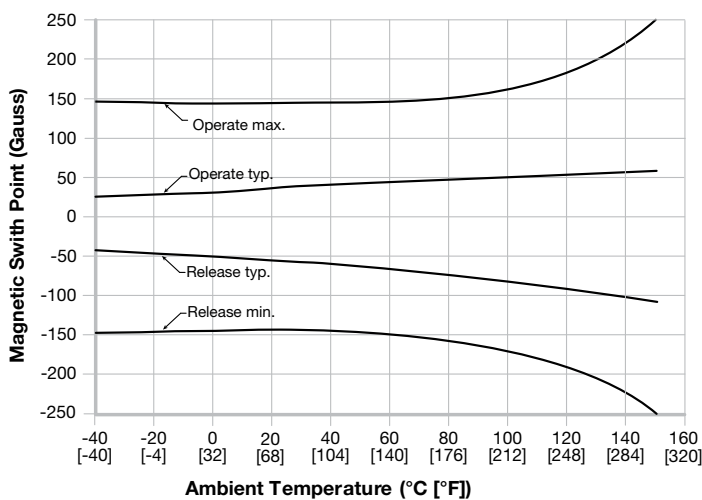

Figure 2. Current Sinking Output Block Diagram

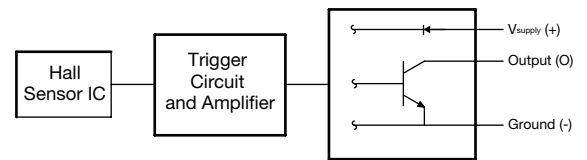
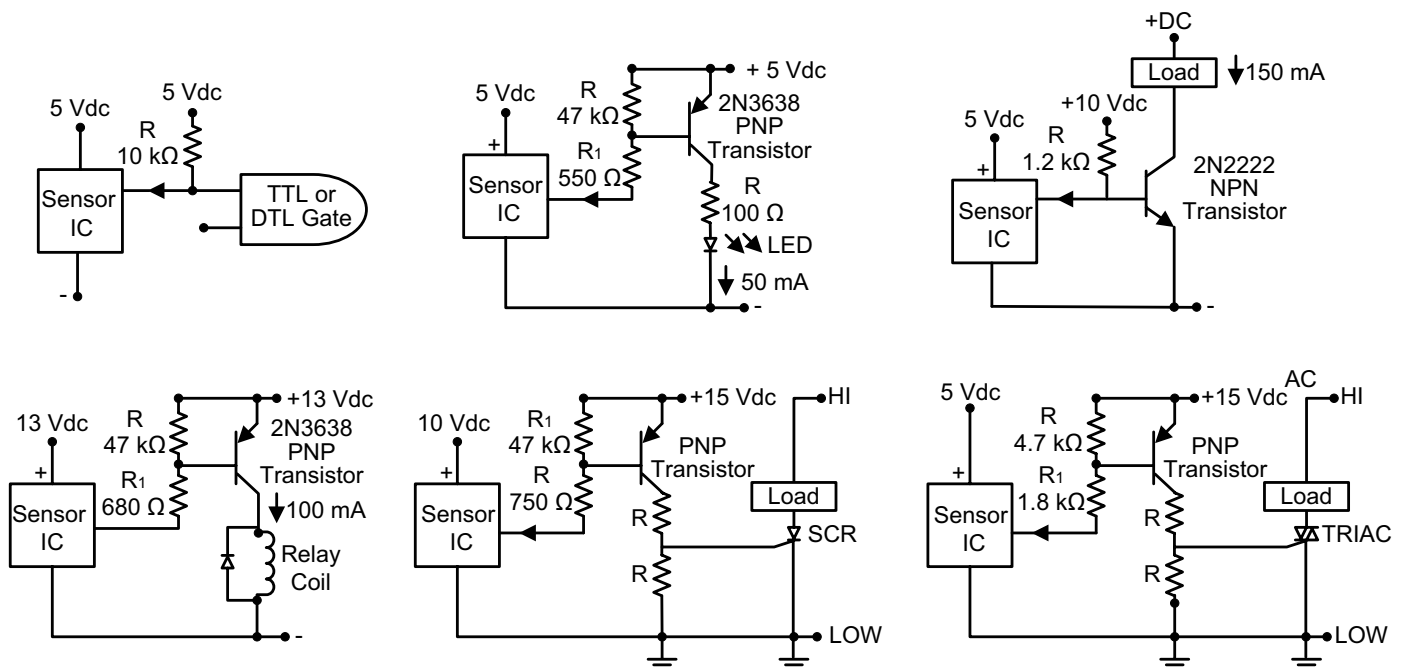

Figure 3. Wiring Diagrams



# Low-cost Digital Bipolar Hall-effect Sensor ICs, SS41F, SS41G

Figure 4. SS41 F, SS41G Sensor IC Mounting Dimensions (For reference only. mm/in.)

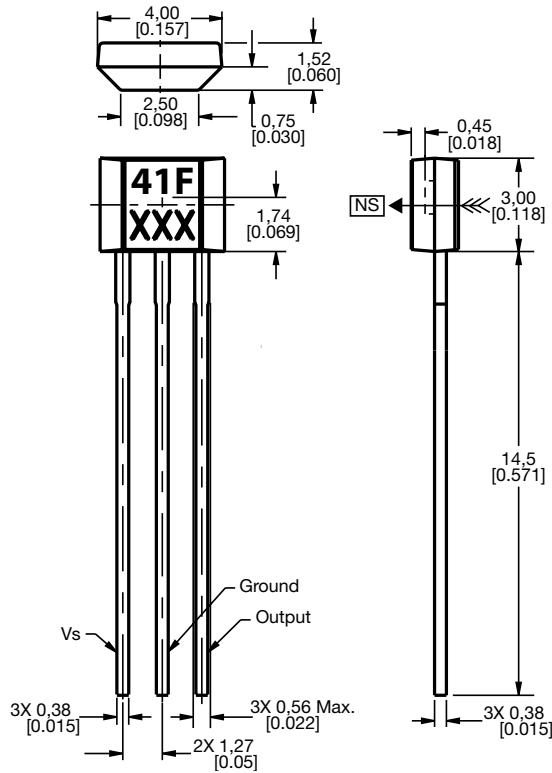



Table 4. Order Guide

Catalog Listing	Description	
SS41F	Low-cost digital bipolar Hall-effect sensor IC, tested at 25 °C [77 °F], flat TO-92-style package, bulk packaging (1000 units per bag)	
SS41G	Low-cost digital bipolar Hall-effect sensor IC, tested at 25 °C [77 °F] and 125 °C [257 °F], flat TO-92-style package, bulk packaging (1000 units per bag)	

## ADDITIONAL INFORMATION

The following associated literature is available on the Honeywell web site at [sensing.honeywell.com](http://sensing.honeywell.com):

- Product Range Guide
- Product Line Guide
- Product Installation Instructions
- Technical Information

### **⚠ WARNING** **PERSONAL INJURY**

DO NOT USE these products as safety or emergency stop devices or in any other application where failure of the product could result in personal injury.

**Failure to comply with these instructions could result in death or serious injury.**

### **⚠ WARNING** **MISUSE OF DOCUMENTATION**

- The information presented in this datasheet is for reference only. Do not use this document as a product installation guide.
- Complete installation, operation, and maintenance information is provided in the instructions supplied with each product.

**Failure to comply with these instructions could result in death or serious injury.**

## Find out more

Honeywell serves its customers through a worldwide network of sales offices, representatives and distributors.

For application assistance, current specifications, pricing or name of the nearest Authorized Distributor, contact your local sales office.

To learn more about Honeywell Sensing and Productivity Solutions' products, call **+1-815-235-6847** or **1-800-537-6945**, visit **[sensing.honeywell.com](http://sensing.honeywell.com)**, or e-mail inquiries to **[info.sc@honeywell.com](mailto:info.sc@honeywell.com)**

Sensing and Productivity Solutions  
1985 Douglas Drive North  
Golden Valley, MN 55422  
**[honeywell.com](http://honeywell.com)**

## Warranty/Remedy

Honeywell warrants goods of its manufacture as being free of defective materials and faulty workmanship. Honeywell's standard product warranty applies unless agreed to otherwise by Honeywell in writing; please refer to your order acknowledgement or consult your local sales office for specific warranty details. If warranted goods are returned to Honeywell during the period of coverage, Honeywell will repair or replace, at its option, without charge those items it finds defective.

**The foregoing is buyer's sole remedy and is in lieu of all other warranties, expressed or implied, including those of merchantability and fitness for a particular purpose. In no event shall Honeywell be liable for consequential, special, or indirect damages.**

While we provide application assistance personally, through our literature and the Honeywell web site, it is up to the customer to determine the suitability of the product in the application.

Specifications may change without notice. The information we supply is believed to be accurate and reliable as of this printing. However, we assume no responsibility for its use.

# Honeywell