

INDUCTORS / BEADS





4	SMD Chip Beads [SB/NB/HF/GB/PB/UPB Series]
18	SMD Chip Beads [FB Series]
21	SMD Multilayer Chip Inductors [CL Series]
28	SMD Multilayer Chip Inductors [CLH Series]
33	SMD Wire Wound Chip Inductors [SQV Series]
37	SMD Wire Wound Chip Inductors [SQC Series]
42	SMD Wire Wound Chip Inductors [NL Series]
48	SMD Wire Wound Chip Inductors [NLC Series]
51	SMD Wire Wound Chip Inductors [NLV Series]
55	SMD Wire Wound Chip Inductors [NLCV Series]
58	SMD Wire Wound Chip Inductors [LS Series]
62	SMD Wire Wound Chip Inductors [LT Series]
66	SMD Wire Wound Chip Inductors [LD Series]
69	SMD Wire Wound Chip Inductors [PS Series]
72	SMD Wire Wound Chip Inductors [CS Series]
78	SMD Wire Wound Chip Inductors [CT Series]
81	SMD Wire Wound Chip Inductors [HC Series]
84	SMD Wire Wound Chip Inductors [HQ Series]
88	SMD Wire Wound Chip Inductors [LCN Series]
94	SMD Wire Wound Chip Inductors [CMM Series]
97	SMD Power Inductors [SSL Series]
106	SMD Power Inductors [SSL_HC Series]
110	SMD Power Inductors [SCD Series]
115	SMD Power Inductors [SCDS Series]
129	SMD Power Inductors [SDS Series]
134	SMD Power Inductors [SDT Series]
137	SMD Power Inductors [SLF Series]
145	SMD Power Inductors [SCDA Series]
148	SMD Power Inductors [STD Series]
151	SMD Power Inductors [SLH Series]
156	SMD Power Inductors [SFI Series]
158	DIP Power Inductors [PMC Series]
161	DIP Power Inductors [PMD Series]
164	DIP Power Inductors [PMF Series]
168	DIP Power Inductors [NSF Series]
172	DIP Power Inductors [MC Series]
175	DIP Power Inductors [SLM Series]
179	DIP Power Inductors [SL Series]
183	DIP Power Inductors [MB Series]
186	DIP Power Inductors [BC Series]

SMD Chip Beads

SB/NB/HF/GB/PB/UPB



OUTLINE

Yageo offers hundreds of multi-layered ferrite chip beads with various sizes, frequency characteristics, and a wide range of impedance values to provide powerful solutions for EMI problems.

Three formulas of ferrite compose several types of EMI suppression chip beads that are classified into six categories- SB, NB, HF, GB, PB and UPB series.

PRODUCT IDENTIFICATION

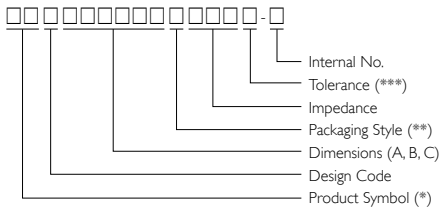

- Product Symbol: SB, NB, HF, GB, PB, UPB
- Packaging: T = Tape and Reel, B = Bulk
- Tolerance: M = ±20%, Y = ±25%, T = ±30%
- Internal No.: N = Lead-Free

SHAPES AND DIMENSIONS

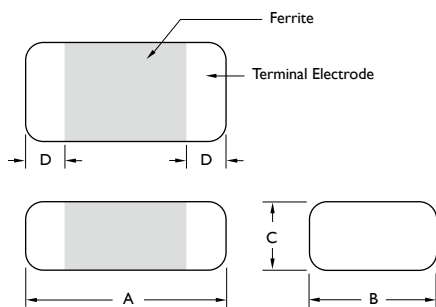

Unit: mm

TYPE		A	B	C	D
SB/NB/PB/HF	100505	1.0 ± 0.10	0.50 ± 0.10	0.5 ± 0.10	0.25 ± 0.10
SB/NB/GB/PB/UPB/HF	160808	1.6 ± 0.15	0.80 ± 0.15	0.8 ± 0.15	0.3 ± 0.2
SB/NB/GB/PB/UPB	201209	2.0 ± 0.20	1.25 ± 0.20	0.9 ± 0.20	0.5 ± 0.3
UPB	201212	2.0 ± 0.20	1.25 ± 0.20	1.25 ± 0.20	0.5 ± 0.3
SB/NB/GB/PB/UPB	321611	3.2 ± 0.20	1.60 ± 0.20	1.1 ± 0.20	0.5 ± 0.3
SB/GB	321616	3.2 ± 0.20	1.60 ± 0.20	1.6 ± 0.20	0.5 ± 0.3
SB/GB/PB	322513	3.2 ± 0.20	2.50 ± 0.20	1.3 ± 0.20	0.5 ± 0.3
SB/GB/PB/UPB	451616	4.5 ± 0.25	1.60 ± 0.20	1.6 ± 0.20	0.5 ± 0.3
SB/GB/PB/UPB	453215	4.5 ± 0.25	3.20 ± 0.20	1.5 ± 0.20	0.5 ± 0.3

ELECTRICAL CHARACTERISTICS SB Series

PART NO.	IMPEDANCE (Ω) $\pm 25\%$	TEST FREQUENCY (MHz)	DC RESISTANCE (Ω) Max.	RATED CURRENT (mA) Max.
SBY100505T-060Y-N	6	100	0.05	500
SBY100505T-100Y-N	10	100	0.05	500
SBY100505T-400Y-N	40	100	0.20	500
SBY100505T-800Y-N	80	100	0.20	500
SBY100505T-121Y-N	120	100	0.25	500
SBY100505T-241Y-N	240	100	0.40	400
SBY100505T-481Y-N	480	100	0.50	300
SBY100505T-601Y-N	600	100	0.60	300
SBY100505T-102Y-N	1,000	100	0.95	200
SBY100505T-152Y-N	1,500	100	1.15	100
SBY100505T-182Y-N	1,800	100	1.40	100
SBK160808T-110Y-N	11	100	0.05	500
SBK160808T-190Y-N	19	100	0.08	500
SBK160808T-300Y-N	30	100	0.10	400
SBK160808T-400Y-N	40	100	0.10	400
SBK160808T-600Y-N	60	100	0.10	400
SBK160808T-800Y-N	80	100	0.15	400
SBK160808T-121Y-N	120	100	0.25	400
SBK160808T-221Y-N	220	100	0.30	300
SBK160808T-301Y-N	300	100	0.40	300
SBK160808T-451Y-N	450	100	0.50	300
SBK160808T-601Y-N	600	100	0.50	300
SBK160808T-751Y-N	750	100	0.60	300
SBK160808T-102Y-N	1,000	100	0.60	300
SBK160808T-152Y-N	1,500	100	0.60	300
SBK160808T-222Y-N	2,200	100	0.80	200
SBK160808T-272Y-N	2,700	100	0.80	200



ELECTRICAL CHARACTERISTICS SB Series

PART NO.	IMPEDANCE (Ω) $\pm 25\%$	TEST FREQUENCY (MHz)	DC RESISTANCE (Ω) Max.	RATED CURRENT (mA) Max.
SBY201209T-070Y-N	7	100	0.10	600
SBY201209T-090Y-N	9	100	0.10	600
SBY201209T-110Y-N	11	100	0.10	600
SBY201209T-170Y-N	17	100	0.10	600
SBY201209T-320Y-N	32	100	0.10	600
SBK201209T-600Y-N	60	100	0.15	500
SBK201209T-700Y-N	70	100	0.15	500
SBK201209T-800Y-N	80	100	0.15	500
SBK201209T-121Y-N	120	100	0.25	300
SBK201209T-151Y-N	150	100	0.25	300
SBK201209T-221Y-N	220	100	0.30	300
SBK201209T-301Y-N	300	100	0.30	300
SBK201209T-401Y-N	400	100	0.30	300
SBK201209T-501Y-N	500	100	0.40	300
SBK201209T-601Y-N	600	100	0.40	300
SBK201209T-751Y-N	750	100	0.50	200
SBK201209T-102Y-N	1,000	100	0.50	200
SBK201209T-152Y-N	1,500	100	0.60	200
SBK201209T-202Y-N	2,000	100	0.70	200
SBK201209T-222Y-N	2,200	100	0.70	200
SBK201209T-252Y-N	2,500	100	0.70	200
SBK201209T-272Y-N	2,700	100	0.70	200
SBY321611T-190Y-N	19	100	0.05	600
SBY321611T-260Y-N	26	100	0.05	600
SBY321611T-320Y-N	32	100	0.05	600
SBY321611T-500Y-N	50	100	0.10	500
SBY321611T-600Y-N	60	100	0.10	500
SBK321611T-700Y-N	70	100	0.10	500
SBK321611T-900Y-N	90	100	0.15	500
SBK321611T-121Y-N	120	100	0.15	500
SBK321611T-151Y-N	150	100	0.15	500
SBK321611T-201Y-N	200	100	0.20	400
SBK321611T-401Y-N	400	100	0.20	400
SBK321611T-501Y-N	500	100	0.20	400
SBK321611T-601Y-N	600	100	0.30	400
SBK321611T-102Y-N	1,000	50	0.40	200
SBK321611T-122Y-N	1,200	50	0.40	200
SBK321611T-152Y-N	1,500	50	0.45	200
SBK321611T-202Y-N	2,000	30	0.60	200
SBK321611T-272Y-N	2,700	30	0.60	200

ELECTRICAL CHARACTERISTICS SB Series

PART NO.	IMPEDANCE (Ω) $\pm 25\%$	TEST FREQUENCY (MHz)	DC RESISTANCE (Ω) Max.	RATED CURRENT (mA) Max.
SBY321616T-250Y-N	25	100	0.10	500
SBY321616T-600Y-N	60	100	0.20	500
SBK321616T-700Y-N	70	100	0.20	500
SBY322513T-320Y-N	32	100	0.20	500
SBY322513T-600Y-N	60	100	0.20	500
SBY322513T-900Y-N	90	100	0.20	500
SBY451616T-500Y-N	50	100	0.20	600
SBY451616T-600Y-N	60	100	0.20	600
SBY451616T-800Y-N	80	100	0.20	600
SBY451616T-101Y-N	100	100	0.30	500
SBK451616T-151Y-N	150	100	0.30	500
SBK451616T-171Y-N	170	100	0.30	500
SBY453215T-700Y-N	70	100	0.30	500
SBY453215T-121Y-N	120	100	0.30	500



ELECTRICAL CHARACTERISTICS NB Series

PART NO.	IMPEDANCE (Ω) $\pm 25\%$	TEST FREQUENCY (MHz)	DC RESISTANCE (Ω) Max.	RATED CURRENT (mA) Max.
NBQ100505T-060Y-N	6	100	0.08	500
NBQ100505T-100Y-N	10	100	0.10	500
NBQ100505T-400Y-N	40	100	0.25	400
NBQ100505T-800Y-N	80	100	0.30	400
NBQ100505T-121Y-N	120	100	0.40	350
NBQ100505T-221Y-N	220	100	0.60	200
NBQ100505T-301Y-N	300	100	1.00	200
NBQ100505T-481Y-N	480	100	1.10	200
NBQ100505T-601Y-N	600	100	1.20	200
NBQ160808T-060Y-N	6	100	0.05	700
NBQ160808T-100Y-N	10	100	0.07	500
NBQ160808T-400Y-N	40	100	0.20	500
NBQ160808T-600Y-N	60	100	0.25	500
NBQ160808T-800Y-N	80	100	0.25	500
NBQ160808T-121Y-N	120	100	0.30	400
NBQ160808T-241Y-N	240	100	0.35	400
NBQ160808T-301Y-N	300	100	0.40	400
NBQ160808T-481Y-N	480	100	0.50	200
NBQ160808T-601Y-N	600	100	0.50	200
NBQ160808T-102Y-N	1,000	100	0.60	200
NBQ160808T-122Y-N	1,200	100	0.60	100
NBQ160808T-152Y-N	1,500	100	0.70	100
NBQ160808T-182Y-N	1,800	100	0.80	100
NBQ160808T-222Y-N	2,200	100	1.00	100
NBQ160808T-252Y-N	2,500	100	1.00	100

ELECTRICAL CHARACTERISTICS NB Series

PART NO.	IMPEDANCE (Ω) $\pm 25\%$	TEST FREQUENCY (MHz)	DC RESISTANCE (Ω) Max.	RATED CURRENT (mA) Max.
NBQ201209T-060Y-N	6	100	0.07	800
NBQ201209T-110Y-N	11	100	0.10	700
NBQ201209T-260Y-N	26	100	0.15	600
NBQ201209T-320Y-N	32	100	0.15	600
NBQ201209T-600Y-N	60	100	0.15	500
NBQ201209T-750Y-N	75	100	0.15	500
NBQ201209T-900Y-N	90	100	0.15	500
NBQ201209T-121Y-N	120	100	0.20	500
NBQ201209T-151Y-N	150	100	0.20	500
NBQ201209T-171Y-N	170	100	0.30	500
NBQ201209T-221Y-N	220	100	0.30	500
NBQ201209T-301Y-N	300	100	0.30	500
NBQ201209T-401Y-N	400	100	0.35	500
NBQ201209T-501Y-N	500	100	0.35	500
NBQ201209T-601Y-N	600	100	0.35	500
NBQ201209T-102Y-N	1,000	100	0.40	400
NBQ201209T-122Y-N	1,200	100	0.45	400
NBQ201209T-152Y-N	1,500	100	0.45	400
NBQ201209T-222Y-N	2,200	100	0.50	400
NBQ201209T-272Y-N	2,700	100	0.60	200
NBQ321611T-320Y-N	32	100	0.15	600
NBQ321611T-600Y-N	60	100	0.15	500
NBQ321611T-800Y-N	80	100	0.15	500
NBQ321611T-900Y-N	90	100	0.15	500
NBQ321611T-121Y-N	120	100	0.20	500
NBQ321611T-151Y-N	150	100	0.20	500
NBQ321611T-201Y-N	200	100	0.25	400
NBQ321611T-221Y-N	220	100	0.30	400
NBQ321611T-351Y-N	350	100	0.30	400
NBQ321611T-401Y-N	400	100	0.30	400
NBQ321611T-601Y-N	600	100	0.35	400
NBQ321611T-122Y-N	1,200	100	0.40	300
NBQ321611T-152Y-N	1,500	100	0.45	300



ELECTRICAL CHARACTERISTICS NB Series

PART NO.	IMPEDANCE (Ω) $\pm 25\%$	TEST FREQUENCY (MHz)	DC RESISTANCE (Ω) Max.	RATED CURRENT (mA) Max.
NBP160808T-220Y-N	22	100	0.07	1,800
NBP160808T-300Y-N	30	100	0.07	1,800
NBP160808T-600Y-N	60	100	0.10	1,500
NBP160808T-800Y-N	80	100	0.12	1,200
NBP160808T-121Y-N	120	100	0.15	1,000
NBP201209T-070Y-N	7	100	0.03	2,000
NBP201209T-320Y-N	32	100	0.05	1,800
NBP201209T-400Y-N	40	100	0.08	1,500
NBP201209T-600Y-N	60	100	0.08	1,500
NBP201209T-121Y-N	120	100	0.10	1,000
NBP201209T-221Y-N	220	100	0.15	800
NBP321611T-150Y-N	15	100	0.04	2,000
NBP321611T-190Y-N	19	100	0.04	2,000
NBP321611T-300Y-N	30	100	0.06	1,800
NBP321611T-600Y-N	60	100	0.08	1,500
NBP321611T-121Y-N	120	100	0.10	1,200
NBP321611T-221Y-N	220	100	0.12	1,200
NBP321611T-601Y-N	600	100	0.15	1,000

ELECTRICAL CHARACTERISTICS HF Series

PART NO.	IMPEDANCE (Ω) $\pm 25\%$	TEST FREQUENCY (MHz)	IMPEDANCE (Ω) Max.	TEST FREQUENCY (MHz)	DC RESISTANCE (Ω) Max.	RATED CURRENT (mA) Max.
HFJ100505T-601Y-N	600	100	1,400	1,000	0.850	300
HFJ100505T-102Y-N	1,000	100	2,000	1,000	1.250	250
HFJ100505T-152Y-N	1,500	100	2,400	1,000	1.800	230
HFJ100505T-182Y-N	1,800	100	2,700	1,000	2.200	200
HFJ160808T-471Y-N	470	100	1,000	1,000	1.000	100
HFJ160808T-601Y-N	600	100	1,200	1,000	1.100	100
HFJ160808T-102Y-N	1,000	100	1,200	1,000	1.600	50
HFJ160808T-152Y-N	1,500	100	1,500	1,000	1.700	50
HFQ100505T-121Y-N	120	100	500	1,000	0.700	300
HFQ100505T-221Y-N	220	100	900	1,000	1.000	250
HFQ160808T-121Y-N	120	100	500	1,000	0.500	200
HFQ160808T-221Y-N	220	100	1,100	1,000	0.800	100
HFQ160808T-301Y-N	300	100	1,300	1,000	1.100	80
HFQ160808T-331Y-N	330	100	1,600	1,000	1.200	50
HFV160808T-601Y-N	600	100	600	1,000	0.250	800
HFV160808T-102Y-N	1,000	100	1,000	1,000	0.350	600
HFV160808T-152Y-N	1,500	100	1,500	1,000	0.500	500
HFY100505T-601Y-N	600	100	1,000	1,000	0.700	300
HFY100505T-102Y-N	1,000	100	1,400	1,000	1.100	250
HFY100505T-121Y-NP	120	100	150	1,000	0.095	1,500
HFY100505T-221Y-NP	220	100	270	1,000	0.280	700
HFY160808T-301Y-N	300	100	550	1,000	0.700	200
HFY160808T-471Y-N	470	100	600	1,000	0.700	200
HFY160808T-601Y-N	600	100	700	1,000	0.800	200
HFY160808T-102Y-N	1,000	100	1,000	1,000	1.500	100
HFY160808T-152Y-N	1,500	100	1,500	1,000	1.600	100
HFY160808T-331Y-NP	330	100	450	1,000	0.210	500
HFY160808T-391Y-NP	390	100	520	1,000	0.210	500
HFY160808T-471Y-NP	470	100	600	1,000	0.210	500
HFY160808T-601Y-NP	600	100	700	1,000	0.350	500
HFY160808T-102Y-NP	1,000	100	1,000	1,000	0.500	450



ELECTRICAL CHARACTERISTICS GB Series

PART NO.	IMPEDANCE (Ω) $\pm 25\%$	TEST FREQUENCY (MHz)	DC RESISTANCE (Ω) Max.	RATED CURRENT (mA) Max.
GBK160808T-110Y-N	11	100	0.03	1,000
GBK160808T-190Y-N	19	100	0.05	1,000
GBK160808T-300Y-N	30	100	0.06	800
GBK160808T-400Y-N	40	100	0.06	800
GBK160808T-600Y-N	60	100	0.06	600
GBK160808T-800Y-N	80	100	0.10	600
GBK160808T-121Y-N	120	100	0.15	600
GBK160808T-221Y-N	220	100	0.18	400
GBK160808T-301Y-N	300	100	0.25	400
GBK160808T-451Y-N	450	100	0.30	400
GBK160808T-601Y-N	600	100	0.30	400
GBK160808T-751Y-N	750	100	0.45	300
GBK160808T-102Y-N	1,000	100	0.45	300
GBY201209T-070Y-N	7	100	0.06	1,000
GBY201209T-090Y-N	9	100	0.06	1,000
GBY201209T-110Y-N	11	100	0.06	1,000
GBY201209T-170Y-N	17	100	0.06	1,000
GBY201209T-320Y-N	32	100	0.06	1,000
GBK201209T-600Y-N	60	100	0.10	800
GBK201209T-700Y-N	70	100	0.10	800
GBK201209T-800Y-N	80	100	0.10	800
GBK201209T-121Y-N	120	100	0.15	600
GBK201209T-151Y-N	150	100	0.15	600
GBK201209T-221Y-N	220	100	0.18	600
GBK201209T-301Y-N	300	100	0.18	600
GBK201209T-401Y-N	400	100	0.18	600
GBK201209T-501Y-N	500	100	0.25	500
GBK201209T-601Y-N	600	100	0.25	500
GBK201209T-751Y-N	750	100	0.30	400
GBK201209T-102Y-N	1,000	100	0.30	400
GBK201209T-152Y-N	1,500	100	0.40	400
GBK201209T-202Y-N	2,000	100	0.55	400

ELECTRICAL CHARACTERISTICS GB Series

PART NO.	IMPEDANCE (Ω) $\pm 25\%$	TEST FREQUENCY (MHz)	DC RESISTANCE (Ω) Max.	RATED CURRENT (mA) Max.
GBY321611T-190Y-N	19	100	0.03	1,000
GBY321611T-260Y-N	26	100	0.03	1,000
GBY321611T-320Y-N	32	100	0.03	1,000
GBY321611T-500Y-N	50	100	0.06	800
GBY321611T-600Y-N	60	100	0.06	800
GBK321611T-700Y-N	70	100	0.06	800
GBK321611T-900Y-N	90	100	0.10	800
GBK321611T-121Y-N	120	100	0.10	800
GBK321611T-151Y-N	150	100	0.10	800
GBK321611T-201Y-N	200	100	0.15	600
GBK321611T-401Y-N	400	100	0.15	600
GBK321611T-501Y-N	500	100	0.15	600
GBK321611T-601Y-N	600	100	0.20	500
GBK321611T-102Y-N	1,000	50	0.25	400
GBK321611T-122Y-N	1,200	50	0.25	400
GBK321611T-202Y-N	2,000	30	0.35	400
GBY321616T-250Y-N	25	100	0.10	1,000
GBY321616T-600Y-N	60	100	0.10	1,000
GBK321616T-700Y-N	70	100	0.10	1,000
GBY322513T-320Y-N	32	100	0.10	1,000
GBY322513T-600Y-N	60	100	0.10	1,000
GBY322513T-900Y-N	90	100	0.10	1,000
GBY451616T-500Y-N	50	100	0.10	1,000
GBY451616T-600Y-N	60	100	0.10	1,000
GBY451616T-800Y-N	80	100	0.10	1,000
GBY451616T-101Y-N	100	100	0.18	800
GBK451616T-151Y-N	150	100	0.18	800
GBK451616T-171Y-N	170	100	0.18	800
GBY453215T-700Y-N	70	100	0.18	800
GBY453215T-121Y-N	120	100	0.18	800



ELECTRICAL CHARACTERISTICS PB Series

PART NO.	IMPEDANCE (Ω) $\pm 25\%$	TEST FREQUENCY (MHz)	DC RESISTANCE (Ω) Max.	RATED CURRENT (mA) Max.
PBY100505T-100Y-N	10	100	0.030	2,000
PBY100505T-300Y-N	30	100	0.050	1,700
PBY100505T-400Y-N	40	100	0.075	1,500
PBY100505T-600Y-N	60	100	0.075	1,500
PBY100505T-700Y-N	70	100	0.090	1,200
PBY100505T-800Y-N	80	100	0.090	1,200
PBY100505T-121Y-N	120	100	0.090	1,200
PBY160808T-110Y-N	11	100	0.020	4,000
PBY160808T-250Y-N	25	100	0.030	3,000
PBY160808T-400Y-N	40	100	0.035	3,000
PBY160808T-600Y-N	60	100	0.040	3,000
PBY160808T-121Y-N	120	100	0.080	2,500
PBY160808T-151Y-N	150	100	0.085	2,000
PBY160808T-181Y-N	180	100	0.090	2,000
PBY160808T-201Y-N	200	100	0.095	2,000
PBY160808T-301Y-N	300	100	0.120	1,500
PBY160808T-501Y-N	500	100	0.150	1,200
PBY160808T-601Y-N	600	100	0.200	1,000
PBY160808T-102Y-N	1,000	100	0.250	800
PBY201209T-110Y-N	11	100	0.010	6,000
PBY201209T-170Y-N	17	100	0.020	5,000
PBY201209T-300Y-N	30	100	0.015	4,000
PBY201209T-500Y-N	50	100	0.025	3,000
PBY201209T-600Y-N	60	100	0.030	3,000
PBY201209T-800Y-N	80	100	0.040	3,000
PBY201209T-121Y-N	120	100	0.040	3,000
PBY201209T-201Y-N	200	100	0.050	2,500
PBY201209T-301Y-N	300	100	0.080	2,000
PBY201209T-601Y-N	600	100	0.100	2,000
PBY201209T-102Y-N	1,000	100	0.120	1,500

ELECTRICAL CHARACTERISTICS PB Series

PART NO.	IMPEDANCE (Ω) $\pm 25\%$	TEST FREQUENCY (MHz)	DC RESISTANCE (Ω) Max.	RATED CURRENT (mA) Max.
PBY321611T-190Y-N	19	100	0.015	6,000
PBY321611T-320Y-N	32	100	0.015	4,000
PBY321611T-500Y-N	50	100	0.020	4,000
PBY321611T-800Y-N	80	100	0.025	3,000
PBY321611T-101Y-N	100	100	0.030	3,000
PBY321611T-121Y-N	120	100	0.030	3,000
PBY321611T-221Y-N	220	100	0.050	2,000
PBY321611T-301Y-N	300	100	0.060	2,000
PBY321611T-601Y-N	600	100	0.100	2,000
PBY321611T-102Y-N	1,000	50	0.150	1,200
PBY321611T-122Y-N	1,200	50	0.180	1,000
PBY321611T-152Y-N	1,500	50	0.200	800
PBY322513T-600Y-N	60	100	0.025	4,000
PBY322513T-900Y-N	90	100	0.025	3,000
PBY451616T-500Y-N	50	100	0.020	6,000
PBY451616T-600Y-N	60	100	0.020	5,000
PBY451616T-800Y-N	80	100	0.025	4,000
PBY451616T-900Y-N	90	100	0.040	4,000
PBY451616T-151Y-N	150	100	0.100	2,000
PBY451616T-471Y-N	470	100	0.100	2,000
PBY451616T-102Y-N	1,000	100	0.100	2,000
PBY453215T-700Y-N	70	100	0.030	6,000
PBY453215T-121Y-N	120	100	0.030	4,000
PBY453215T-151Y-N	150	100	0.028	4,000
PBY453215T-601Y-N	600	100	0.028	4,000
PBY453215T-132Y-N	1,300	100	0.150	1,500



ELECTRICAL CHARACTERISTICS UPB Series

PART NO.	IMPEDANCE (Ω) $\pm 25\%$	TEST FREQUENCY (MHz)	DC RESISTANCE (Ω) Max.	RATED CURRENT (mA) Max.
UPB160808T-110Y-N	11	100	0.015	4,500
UPB160808T-170Y-N	17	100	0.015	4,500
UPB160808T-250Y-N	25	100	0.015	4,500
UPB160808T-300Y-N	30	100	0.015	4,500
UPB201209T-110Y-N	11	100	0.015	6,000
UPB201209T-150Y-N	15	100	0.015	6,000
UPB201209T-190Y-N	19	100	0.015	6,000
UPB201209T-260Y-N	26	100	0.015	6,000
UPB201209T-300Y-N	30	100	0.015	6,000
UPB201209T-330Y-N	33	100	0.015	6,000
UPB201209T-400Y-N	40	100	0.015	6,000
UPB201209T-500Y-N	50	100	0.015	6,000
UPB201209T-600Y-N	60	100	0.020	4,500
UPB201209T-800Y-N	80	100	0.020	4,500
UPB201209T-101Y-N	100	100	0.020	5,000
UPB201209T-121Y-N	120	100	0.020	5,000
UPB201212T-600Y-N	60	100	0.020	6,000
UPB201212T-700Y-N	70	100	0.020	6,000
UPB201212T-800Y-N	80	100	0.020	6,000
UPB201212T-101Y-N	100	100	0.025	5,000
UPB201212T-121Y-N	120	100	0.025	5,000
UPB321611T-110Y-N	11	100	0.012	6,000
UPB321611T-190Y-N	19	100	0.012	6,000
UPB321611T-260Y-N	26	100	0.012	6,000
UPB321611T-300Y-N	30	100	0.012	6,000
UPB321611T-400Y-N	40	100	0.012	6,000
UPB321611T-500Y-N	50	100	0.012	6,000
UPB321611T-600Y-N	60	100	0.012	6,000
UPB321611T-800Y-N	80	100	0.012	6,000
UPB321611T-101Y-N	100	100	0.012	6,000
UPB321611T-121Y-N	120	100	0.012	6,000
UPB321611T-151Y-N	150	100	0.020	4,500
UPB451616T-600Y-N	100	60	0.012	7,000
UPB453215T-700Y-N	100	70	0.010	9,000

TAPE DIMENSIONS

Unit: mm

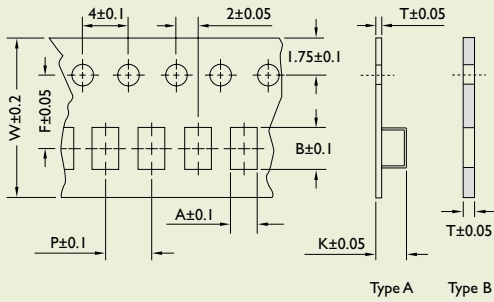

TYPE		A	B	T	W	P	F	K	TAPE TYPE
SB/NB/PB/HF	100505	0.65	1.15	0.60	8.0	2.0	3.5	-	B
SB/NB/GB/PB/UPB/HF	160808	1.05	1.85	0.95	8.0	4.0	3.5	-	B
SB/NB/GB/PB/UPB	201209	1.50	2.30	0.97	8.0	4.0	3.5	-	B
UPB	201212	1.35	2.25	0.22	8.0	4.0	3.5	1.35	A
SB/NB/GB/PB/UPB	321611	1.88	3.50	0.22	8.0	4.0	3.5	1.27	A
SB/GB	321616	1.88	3.53	0.22	8.0	4.0	3.5	1.80	A
SB/GB/PB	322513	2.77	3.42	0.22	8.0	4.0	3.5	1.55	A
SB/GB/PB/UPB	451616	1.93	4.95	0.24	12.0	4.0	5.5	1.93	A
SB/GB/PB/UPB	453215	3.66	4.95	0.24	12.0	8.0	5.5	1.85	A

TAPE MATERIAL

Carrier Tape : Polystyrene (Type A), Paper (Type B)
Cover Tape : Polyethylene

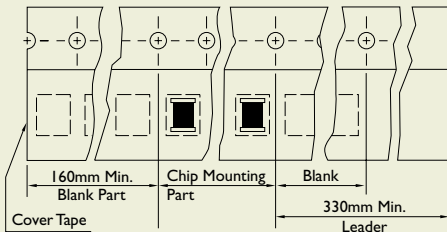

PACKAGING QUANTITY

TYPE		QUANTITY/REEL
SB/NB/PB/HF	100505	10,000
SB/NB/GB/PB/UPB/HF	160808	4,000
SB/NB/GB/PB/UPB	201209	4,000
UPB	201212	3,000
SB/NB/GB/PB/UPB	321611	3,000
SB/GB	321616	2,000
SB/GB/PB	322513	2,500
SB/GB/PB/UPB	451616	2,000
SB/GB/PB/UPB	453215	1,000

REEL DIMENSIONS

Unit: mm

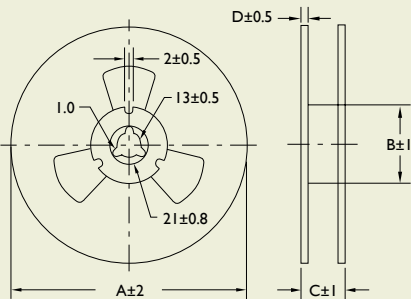

TYPE		A	B	C	D
SB/NB/PB/HF	100505	178	60	12	2
SB/NB/GB/PB/UPB/HF	160808	178	60	12	2
SB/NB/GB/PB/UPB	201209	178	60	12	2
UPB	201212	178	60	12	2
SB/NB/GB/PB/UPB	321611	178	60	12	2
SB/GB	321616	178	60	12	2
SB/GB/PB	322513	178	60	12	2
SB/GB/PB/UPB	451616	178	60	14	2
SB/GB/PB/UPB	453215	178	60	14	2

RECOMMENDED PATTERN

Unit: mm

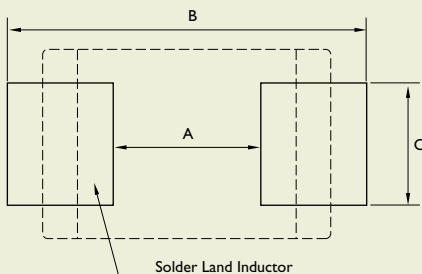

TYPE		A	B	C
SB/NB/PB/HF	100505	0.4	1.2 ~ 1.4	0.5
SB/NB/GB/PB/UPB/HF	160808	0.7 ~ 0.8	1.8 ~ 2.0	0.6 ~ 0.8
SB/NB/GB/PB/UPB	201209	1.0 ~ 1.2	2.6 ~ 4.0	1.0 ~ 1.2
UPB	201212	1.0 ~ 1.2	2.6 ~ 4.0	1.0 ~ 1.2
SB/NB/GB/PB/UPB	321611	2	4.2 ~ 5.2	1.2
SB/GB	321616	2	4.2 ~ 5.2	1.2
SB/GB/PB	322513	2	5.5 ~ 6.5	1.8
SB/GB/PB/UPB	451616	3	5.5 ~ 6.5	1.2
SB/GB/PB/UPB	453215	3	5.5 ~ 6.5	2.4

SMD Chip Beads

FB Series

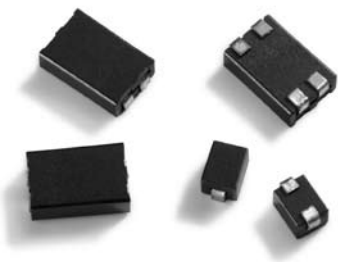

PRODUCT IDENTIFICATION

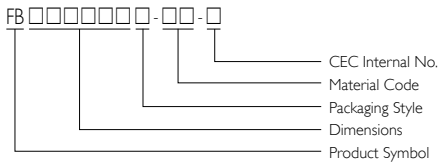

- Packaging: T = Tape and Reel, B = Bulk
- Internal No.: N = Lead-Free

APPLICATIONS

For stereos, car radios, mobile telephones, VCRs, computer disk drives and PC boards in order to filter EMI from the outside.

OUTLINE

Yageo surface mount beads are similar impedance levels to leaded shielded beads.

These beads have high current carrying capacities, compact size are good for use with flow or reflow soldering processes.

FEATURES

Special designs for surface mounting equipment, are available in various sizes which allow them to be used for a wide range of applications.

High resistance fights heat and humidity

SHAPES AND DIMENSIONS

Figure 1

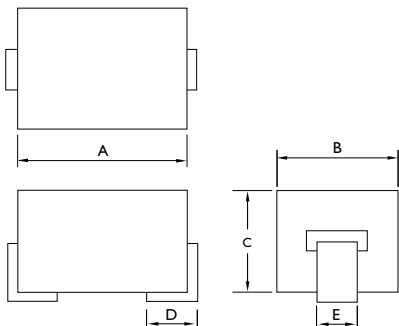

Unit: mm

Figure 2

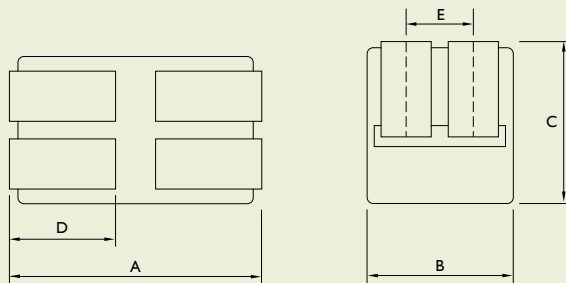

TYPE	A	B	C	D	E	TAPE WIDTH	FIGURE
FB423226	3.81 ~ 4.32	2.92 ~ 3.18	2.41 ~ 2.67	1.27	1.3	12	1
FB784729	7.62 ~ 8.13	4.50 ~ 5.00	2.66 ~ 3.18	2.03	1.3	16	1
FB863226	8.40 ~ 8.75	2.92 ~ 3.18	2.41 ~ 2.67	1.27	1.35	16	1
FB865626	8.9 ± 0.3	5.6 ± 0.2	2.85 ± 0.2	1.35 ± 0.2	2.54 ± 0.1	16	2

ELECTRICAL CHARACTERISTICS

PART NO.	IMPEDANCE (Ω) Min. at 25MHz	IMPEDANCE (Ω) Min. at 100MHz	DC RESISTANCE (Ω) Max.
FB423226-Y7-N	24	36	0.6
FB784729-Y7-N	48	72	0.9
FB863226-Y7-N	48	72	0.9
FB865626-Y7-N	30	60 \pm 20%	-

TAPE DIMENSIONS

Unit: mm

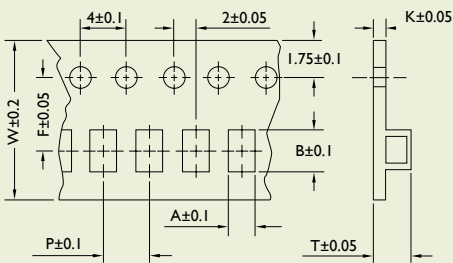

TYPE	A	B	T	W	P	F	K
FB423226	3.64	5.30	3.10	12	8	5.5	0.30
FB784729	5.24	8.77	3.69	16	8	7.5	0.30
FB863226	3.28	9.35	3.06	16	8	7.5	0.30
FB865626	6.30	9.30	3.10	16	8	7.5	0.27

TAPE MATERIAL

PACKAGING QUANTITY

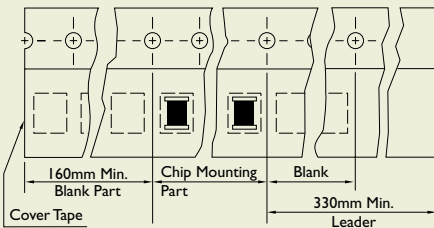

TYPE	QUANTITY/REEL
FB423226	500
FB784729	500
FB863226	500
FB865626	2,400



REEL DIMENSIONS

Unit: mm

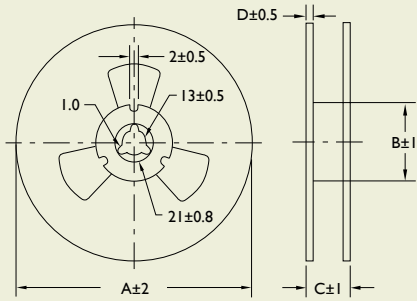

TYPE	A	B	C	D
FB423226	178	60	16	1.5
FB784729	178	60	20	1.5
FB863226	178	60	20	1.5
FB865626	330	100	21	2.0

RECOMMENDED PATTERN

Unit: mm

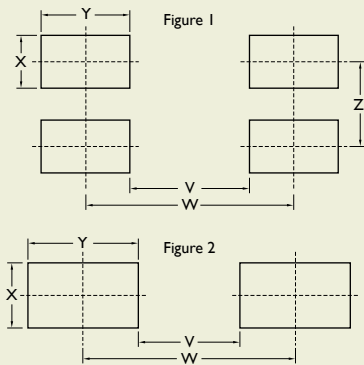

TYPE	V	W	X	Y	Z	FIGURE
FB423226	1.0	4.0	1.8	3.0	-	2
FB784729	5.0	8.0	1.8	3.0	-	2
FB863226	4.5	7.5	1.8	3.0	-	2
FB865626	4.5	7.5	1.8	3.0	2.5	1

CL Series

SMD Multilayer Chip Inductors

APPLICATIONS

Personal computers, HDDs, or other various electronic appliances.

Any general circuit of portable equipment in which compact size and high mounting densities are required.

OUTLINE

Yageo's SMD multi-layered ferrite chip inductors provide a cost-effective solution for densely packed PC board designs.

CL series is suitable for low frequency applications.

FEATURES

High mounting density of compact circuit due to crosstalk elimination that results from a closed magnetic flux in a ferrite material.

Suitable for flow and re-flow soldering



PRODUCT IDENTIFICATION

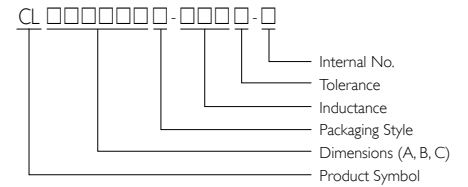

- Packaging: T = Tape and Reel, B = Bulk
- Internal No.: N = Lead-Free

SHAPES AND DIMENSIONS

Unit: mm

TYPE	A	B	C	D
CL100505	1.0 ± 0.10	0.50 ± 0.10	0.50 ± 0.10	0.25 ± 0.10
CL160808	1.6 ± 0.20	0.80 ± 0.20	0.80 ± 0.20	0.30 ± 0.20
CL201209	2.0 ± 0.20	1.25 ± 0.20	0.90 ± 0.20	0.50 ± 0.30
CL201212	2.0 ± 0.20	1.25 ± 0.20	1.25 ± 0.20	0.50 ± 0.30
CL321611	3.2 ± 0.20	1.60 ± 0.20	1.10 ± 0.20	0.50 ± 0.30

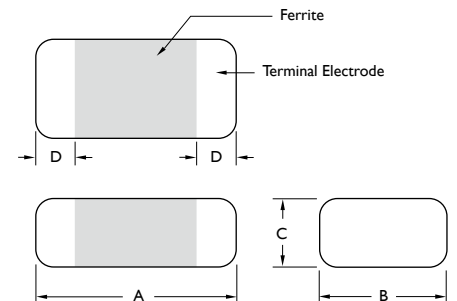



ELECTRICAL CHARACTERISTICS CLI00505

PART NO.	IMPEDANCE (μ H)	TOLERANCE (\pm %)	Q Min.	TEST FREQUENCY (MHz)	SRF (MHz) Min.	DC RESISTANCE (Ω) Max.	IDC (mA) Max.
CLI00505T-10NM-N	0.010	20	8	50	500	0.45	50
CLI00505T-12NM-N	0.012	20	8	50	500	0.45	50
CLI00505T-47NM-N	0.047	20	10	50	500	0.45	50
CLI00505T-68NM-N	0.068	20	10	50	480	0.45	50
CLI00505T-82NM-N	0.082	20	10	50	480	0.45	50
CLI00505T-R10□-N	0.10	10 / 20	15	25	450	0.60	50
CLI00505T-R12□-N	0.12	10 / 20	15	25	400	0.70	25
CLI00505T-R15□-N	0.15	10 / 20	15	25	350	0.80	25
CLI00505T-R18□-N	0.18	10 / 20	15	25	320	0.90	25
CLI00505T-R22□-N	0.22	10 / 20	15	25	290	1.10	25
CLI00505T-R27□-N	0.27	10 / 20	15	25	260	1.30	25
CLI00505T-R33□-N	0.33	10 / 20	15	25	230	1.50	25
CLI00505T-R39□-N	0.39	10 / 20	20	10	210	0.60	10
CLI00505T-R47□-N	0.47	10 / 20	20	10	190	0.65	10
CLI00505T-R56□-N	0.56	10 / 20	20	10	170	0.70	10
CLI00505T-R68□-N	0.68	10 / 20	20	10	150	0.80	10
CLI00505T-R82□-N	0.82	10 / 20	20	10	130	0.90	10
CLI00505T-1R0□-N	1.00	10 / 20	20	10	120	1.00	15
CLI00505T-1R2□-N	1.20	10 / 20	20	10	110	1.10	15
CLI00505T-1R5□-N	1.50	10 / 20	20	10	100	1.20	10
CLI00505T-1R8□-N	1.80	10 / 20	20	10	90	1.30	10

Note:

Tolerance: K = \pm 10%, M = \pm 20%

ELECTRICAL CHARACTERISTICS CL160808

PART NO.	IMPEDANCE (μH)	TOLERANCE (±%)	Q Min.	TEST FREQUENCY (MHz)	SRF (MHz) Min.	DC RESISTANCE (Ω) Max.	IDC (mA) Max.
CL160808T-10NM-N	0.010	20	15	50	300	0.20	50
CL160808T-33NM-N	0.033	20	15	50	270	0.20	50
CL160808T-47NM-N	0.047	20	15	50	260	0.30	50
CL160808T-56NM-N	0.056	20	15	50	255	0.30	50
CL160808T-68NM-N	0.068	20	15	50	250	0.30	50
CL160808T-82NM-N	0.082	20	15	50	245	0.30	50
CL160808T-R10□-N	0.10	10 / 20	25	25	240	0.50	50
CL160808T-R12□-N	0.12	10 / 20	25	25	205	0.50	50
CL160808T-R15□-N	0.15	10 / 20	25	25	180	0.60	50
CL160808T-R18□-N	0.18	10 / 20	25	25	165	0.60	50
CL160808T-R22□-N	0.22	10 / 20	25	25	150	0.80	50
CL160808T-R27□-N	0.27	10 / 20	25	25	136	0.80	50
CL160808T-R33□-N	0.33	10 / 20	25	25	125	0.85	35
CL160808T-R39□-N	0.39	10 / 20	25	25	110	1.00	35
CL160808T-R47□-N	0.47	10 / 20	25	25	105	1.35	35
CL160808T-R56□-N	0.56	10 / 20	25	25	95	1.50	35
CL160808T-R68□-N	0.68	10 / 20	25	25	85	1.70	35
CL160808T-R82□-N	0.82	10 / 20	25	25	75	2.10	35
CL160808T-1R0□-N	1.00	10 / 20	35	10	65	0.60	25
CL160808T-1R2□-N	1.20	10 / 20	35	10	60	0.80	25
CL160808T-1R5□-N	1.50	10 / 20	35	10	55	0.80	25
CL160808T-1R8□-N	1.80	10 / 20	35	10	50	0.95	25
CL160808T-2R2□-N	2.20	10 / 20	35	10	45	1.00	15
CL160808T-2R7□-N	2.70	10 / 20	35	10	40	1.15	15
CL160808T-3R3□-N	3.30	10 / 20	35	10	38	1.30	15
CL160808T-3R9□-N	3.90	10 / 20	35	10	36	1.50	15
CL160808T-4R7□-N	4.70	10 / 20	35	10	33	1.60	15
CL160808T-5R6□-N	5.60	10 / 20	35	4	22	1.10	5
CL160808T-6R8□-N	6.80	10 / 20	35	4	20	1.30	5
CL160808T-8R2□-N	8.20	10 / 20	30	4	18	1.50	5
CL160808T-100□-N	10	10 / 20	30	2	17	1.70	5
CL160808T-120□-N	12	10 / 20	30	2	15	1.80	3
CL160808T-150□-N	15	10 / 20	20	1	14	1.50	1
CL160808T-180□-N	18	10 / 20	20	1	13	1.60	1
CL160808T-220□-N	22	10 / 20	20	1	11	1.70	1
CL160808T-270□-N	27	10 / 20	20	1	10	1.80	1
CL160808T-330□-N	33	10 / 20	20	1	9	2.20	1

Note:
Tolerance: K = ± 10%, M = ± 20%



ELECTRICAL CHARACTERISTICS CL201209

PART NO.	IMPEDANCE (μH)	TOLERANCE ($\pm\%$)	Q Min.	TEST FREQUENCY (MHz)	SRF (MHz) Min.	DC RESISTANCE (Ω) Max.	IDC (mA) Max.
CL201209T-47NM-N	0.047	20	20	50	320	0.20	300
CL201209T-68NM-N	0.068	20	20	50	280	0.20	300
CL201209T-82NM-N	0.082	20	20	50	255	0.20	300
CL201209T-R10□-N	0.10	10 / 20	25	25	235	0.30	250
CL201209T-R12□-N	0.12	10 / 20	25	25	220	0.30	250
CL201209T-R15□-N	0.15	10 / 20	25	25	200	0.40	250
CL201209T-R18□-N	0.18	10 / 20	25	25	185	0.40	250
CL201209T-R22□-N	0.22	10 / 20	25	25	170	0.50	250
CL201209T-R27□-N	0.27	10 / 20	25	25	150	0.50	250
CL201209T-R33□-N	0.33	10 / 20	25	25	145	0.55	250
CL201209T-R39□-N	0.39	10 / 20	25	25	135	0.65	250
CL201209T-R47□-N	0.47	10 / 20	25	25	125	0.65	250
CL201209T-R56□-N	0.56	10 / 20	25	25	115	0.75	150
CL201209T-R68□-N	0.68	10 / 20	25	25	105	0.80	150
CL201209T-R82□-N	0.82	10 / 20	25	25	100	1.00	150
CL201209T-1R0□-N	1.00	10 / 20	45	10	75	0.40	50
CL201209T-1R2□-N	1.20	10 / 20	45	10	65	0.50	50
CL201209T-1R5□-N	1.50	10 / 20	45	10	60	0.50	50
CL201209T-1R8□-N	1.80	10 / 20	45	10	55	0.60	50
CL201209T-2R2□-N	2.20	10 / 20	45	10	50	0.65	30

ELECTRICAL CHARACTERISTICS CL201212

PART NO.	IMPEDANCE (μH)	TOLERANCE ($\pm\%$)	Q Min.	TEST FREQUENCY (MHz)	SRF (MHz) Min.	DC RESISTANCE (Ω) Max.	IDC (mA) Max.
CL201212T-2R7□-N	2.70	10 / 20	45	10	45	0.75	30
CL201212T-3R3□-N	3.30	10 / 20	45	10	41	0.80	30
CL201212T-3R9□-N	3.90	10 / 20	45	10	38	0.90	30
CL201212T-4R7□-N	4.70	10 / 20	45	10	35	1.00	30
CL201212T-5R6□-N	5.60	10 / 20	45	4	32	0.90	15
CL201212T-6R8□-N	6.80	10 / 20	45	4	29	1.00	15
CL201212T-8R2□-N	8.20	10 / 20	45	4	26	1.10	15
CL201212T-100□-N	10	10 / 20	45	2	24	1.10	15
CL201212T-120□-N	12	10 / 20	45	2	22	1.20	15
CL201212T-150□-N	15	10 / 20	30	1	19	0.80	5
CL201212T-180□-N	18	10 / 20	30	1	18	0.90	5
CL201212T-220□-N	22	10 / 20	30	1	16	1.10	5

Note:

Tolerance: K = $\pm 10\%$, M = $\pm 20\%$

ELECTRICAL CHARACTERISTICS CL321611

PART NO.	IMPEDANCE (μH)	TOLERANCE (\pm%)	Q Min.	TEST FREQUENCY (MHz)	SRF (MHz) Min.	DC RESISTANCE (Ω) Max.	IDC (mA) Max.
CL321611T-47NM-N	0.047	20	20	50	320	0.15	300
CL321611T-68NM-N	0.068	20	20	50	280	0.25	300
CL321611T-82NM-N	0.082	20	20	50	250	0.25	300
CL321611T-R10□-N	0.10	10 / 20	25	25	235	0.25	250
CL321611T-R12□-N	0.12	10 / 20	25	25	220	0.30	250
CL321611T-R15□-N	0.15	10 / 20	25	25	200	0.30	250
CL321611T-R18□-N	0.18	10 / 20	25	25	185	0.40	250
CL321611T-R22□-N	0.22	10 / 20	25	25	170	0.40	250
CL321611T-R27□-N	0.27	10 / 20	25	25	150	0.50	250
CL321611T-R33□-N	0.33	10 / 20	25	25	145	0.50	250
CL321611T-R39□-N	0.39	10 / 20	25	25	135	0.50	200
CL321611T-R47□-N	0.47	10 / 20	25	25	125	0.60	200
CL321611T-R56□-N	0.56	10 / 20	25	25	115	0.70	150
CL321611T-R68□-N	0.68	10 / 20	25	25	105	0.80	150
CL321611T-R82□-N	0.82	10 / 20	25	25	100	0.90	150
CL321611T-1R0□-N	1.00	10 / 20	45	10	75	0.40	100
CL321611T-1R2□-N	1.20	10 / 20	45	10	65	0.50	100
CL321611T-1R5□-N	1.50	10 / 20	45	10	60	0.50	80
CL321611T-1R8□-N	1.80	10 / 20	45	10	55	0.50	70
CL321611T-2R2□-N	2.20	10 / 20	45	10	50	0.60	60
CL321611T-2R7□-N	2.70	10 / 20	45	10	45	0.60	60
CL321611T-3R3□-N	3.30	10 / 20	45	10	41	0.70	60
CL321611T-3R9□-N	3.90	10 / 20	45	10	38	0.80	50
CL321611T-4R7□-N	4.70	10 / 20	45	10	35	0.90	50
CL321611T-5R6□-N	5.60	10 / 20	45	4	32	0.70	25
CL321611T-6R8□-N	6.80	10 / 20	45	4	29	0.80	25
CL321611T-8R2□-N	8.20	10 / 20	45	4	26	0.90	25
CL321611T-100□-N	10	10 / 20	45	2	24	1.00	25
CL321611T-120□-N	12	10 / 20	45	2	22	1.00	15
CL321611T-150□-N	15	10 / 20	35	1	19	0.70	5
CL321611T-180□-N	18	10 / 20	35	1	18	0.75	5
CL321611T-220□-N	22	10 / 20	35	1	16	0.90	5
CL321611T-270□-N	27	10 / 20	35	1	14	0.90	5
CL321611T-330□-N	33	10 / 20	35	1	13	1.05	5

Note:
Tolerance: K = \pm 10%, M = \pm 20%



TAPE DIMENSIONS

Unit: mm

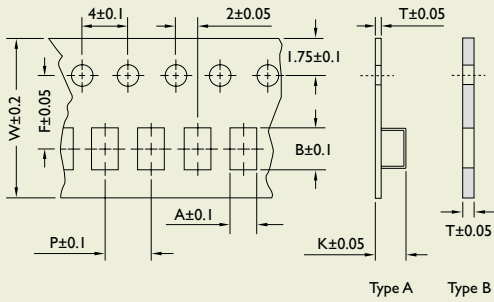

TYPE	A	B	T	W	P	F	K	TAPE TYPE
CL100505	0.65	1.15	0.60	8.0	2.0	3.5	-	B
CL160808	1.05	1.85	0.95	8.0	4.0	3.5	-	B
CL201209	1.50	2.30	0.97	8.0	4.0	3.5	-	B
CL201212	1.35	2.25	0.22	8.0	4.0	3.5	1.35	A
CL321611	1.88	3.50	0.22	8.0	4.0	3.5	1.27	A

TAPE MATERIAL

Carrier Tape : Polystyrene (Type A), Paper (Type B)

Cover Tape : Polyethyeniene

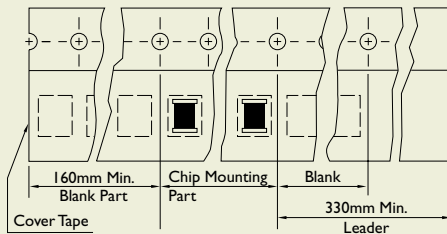

PACKAGING QUANTITY

TYPE	QUANTITY/REEL
CL100505	10,000
CL160808	4,000
CL201209	4,000
CL201212	3,000
CL321611	3,000

REEL DIMENSIONS

Unit: mm

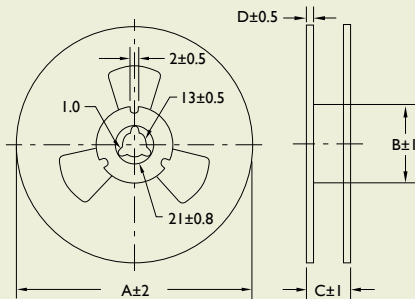

TYPE	A	B	C	D
CL100505	178	60	12	1.5
CL160808	178	60	12	1.5
CL201209	178	60	12	1.5
CL201212	178	60	12	1.5
CL321611	178	60	12	1.5

RECOMMENDED PATTERN

Unit: mm

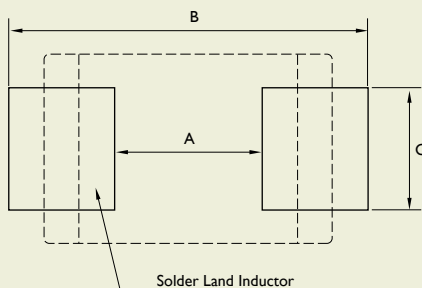

TYPE	A	B	C
CL100505	0.40	1.2 ~ 1.4	0.50
CL160808	0.7 ~ 0.8	1.8 ~ 2.0	0.6 ~ 0.8
CL201209	1.0 ~ 1.2	2.6 ~ 4.0	1.0 ~ 1.2
CL201212	1.0 ~ 1.2	2.6 ~ 4.0	1.0 ~ 1.2
CL321611	2.00	4.2 ~ 5.2	1.20

CL SERIES RELIABILITY TEST

I-1 MECHANICAL PERFORMANCE

NO.	ITEM	SPECIFICATION	TEST CONDITIONS
I-1-1	Flexure Strength	The forces applied on the right conditions must not damage the terminal electrode and the ferrite.	Test device shall be soldered on the substrate. Substrate Dimension: 100 x 40 x 1.6 mm Deflection: 2.0 mm Keeping Time: 30 sec *For: I00505, substrate dimension is 100 x 40 x 0.8 mm
I-1-2	Vibration		Test device shall be soldered on the substrate. Oscillation Frequency: 10 to 55 to 10 Hz for 1 Min. Amplitude: 1.5 mm Time: 2 Hrs. for each Axis (X,Y & Z), Total 6 Hrs.
I-1-3	Resistance to Soldering Heat	Appearance: No damage More than 75% of the terminal electrode should be covered with solder. Inductance: within $\pm 15\%$ of initial value Q change: within $\pm 30\%$ of initial value	Pre-heating: 150 °C, 1 Min. Solder Composition: Sn/Pb = 63/37 Solder Composition: Sn/Ag/Cu = 96.5/3.0/0.5 (Pb-Free) Solder Temperature: 260 \pm 5 °C Immersion Time: 10 \pm 1 Sec.
I-1-4	Solderability	The electrodes shall be at least 90% covered with new solder coating.	Pre-heating: 150 °C, 1 Min. Solder Composition: Sn/Pb = 63/37 Solder Temperature: 220 \pm 5 Solder Composition: Sn/Ag/Cu = 96.5/3.0/0.5 (Pb-Free) Solder Temperature: 245 \pm 5 °C Immersion Time: 4 \pm 1 Sec.

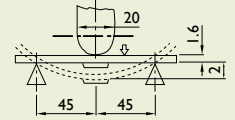

I-2 ENVIRONMENTAL PERFORMANCE

NO.	ITEM	SPECIFICATION	TEST CONDITIONS															
I-2-1	Temperature Cycle	Appearance: No damage Inductance: within $\pm 10\%$ of initial value Q change: within $\pm 30\%$ of initial value	One Cycle <table border="1"> <thead> <tr> <th>Step</th> <th>Temperature (°C)</th> <th>Time (Min.)</th> </tr> </thead> <tbody> <tr> <td>1</td> <td>-25 \pm 3</td> <td>30</td> </tr> <tr> <td>2</td> <td>-25 \pm 2</td> <td>3</td> </tr> <tr> <td>3</td> <td>85 \pm 3</td> <td>30</td> </tr> <tr> <td>4</td> <td>25 \pm 2</td> <td>3</td> </tr> </tbody> </table> Total: 100 Cycles Measured after exposure in the room condition for 24 Hrs.	Step	Temperature (°C)	Time (Min.)	1	-25 \pm 3	30	2	-25 \pm 2	3	3	85 \pm 3	30	4	25 \pm 2	3
Step	Temperature (°C)	Time (Min.)																
1	-25 \pm 3	30																
2	-25 \pm 2	3																
3	85 \pm 3	30																
4	25 \pm 2	3																
I-2-2	Humidity Resistance		Temperature: 40 \pm 2 °C Relative Humidity: 90 ~ 95% Time: 1,000 Hrs. Measured after exposure in the room condition for 24 Hrs.															
I-2-3	High Temperature Resistance		Temperature: 85 \pm 3 °C Relative Humidity: 20% Applied Current: Rated Current Time: 1,000 Hrs. Measured after exposure in the room condition for 24 Hrs.															
I-2-4	Low Temperature Resistance		Temperature: -25 \pm 3 °C Relative Humidity: 0% Time: 1,000 Hrs. Measured after exposure in the room condition for 24 Hrs.															

SMD Multilayer Chip Inductors

CLH Series



PRODUCT IDENTIFICATION

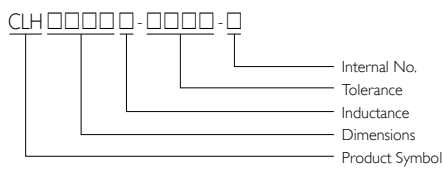

- Packaging: T = Tape and Reel, B = Bulk
- Internal No.: N = Lead-Free
- Product Series Identification:
 - CLH1005-S: Top side full mark, CLH1608-S: Top side full mark
 - CLH2012-S: White

SHAPES AND DIMENSIONS

CLH1005-S / CLH1608-S

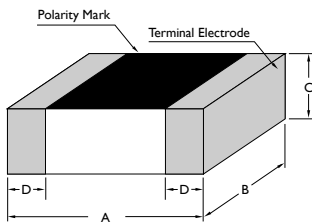

CLH2012-S

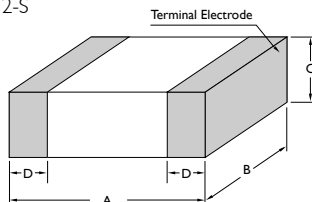

APPLICATIONS

RF Resonance and Impedance Matching Circuit

RF and Wireless Communication

Information technology equipment, computers, telecommunications, radar detectors, automotive electronics, cellular phones, pagers, PDAs, keyless remote systems.

Use in L-C Filter Configurations

OUTLINE

Yageo high frequency multilayer ceramic chip inductor is formed without wound wire.

Monolithic laminated structure

FEATURES

Meet RoHS Criteria for Lead-Free Product

Excellent Q Factor and SRF Characteristic

Cost Effective

Small size of 1005/1608 is suitable for small portable equipment.

Support operating frequency up to 6 GHz with nominal inductance values from 1.0 nH to 470 nH.

Unit: mm					
TYPE	INDUCTANCE RANGE	A	B	C	D
CLH1005	ALL	1.0 ± 0.10	0.50 ± 0.10	0.50 ± 0.10	0.25 ± 0.10
CLH1608	ALL	1.6 ± 0.15	0.8 ± 0.15	0.8 ± 0.15	0.3 ± 0.2
CLH2012	< 390 nH	2.0 ± 0.2	1.25 ± 0.2	0.9 ± 0.2	0.5 ± 0.3
CLH2012	≥ 390 nH	2.0 ± 0.2	1.25 ± 0.2	1.25 ± 0.2	0.5 ± 0.3

ELECTRICAL CHARACTERISTICS CLH1005-S

PART NO.	INDUCTANCE at 100MHz (nH)	TOLERANCE	Q Min.	Q TYPICAL		SRF (MHz) Min.	DC RESISTANCE (Ω) Max.	RATED CURRENT (mA) Max.
			at 100MHz	at 100MHz	at 800MHz			
CLH1005T-1N0□-S	1.0	S	8	9	28	10,000	0.10	400
CLH1005T-1N2□-S	1.2	S	8	9	28	10,000	0.10	400
CLH1005T-1N5□-S	1.5	S	8	10	28	9,000	0.10	400
CLH1005T-1N8□-S	1.8	S	8	10	28	8,700	0.10	400
CLH1005T-2N2□-S	2.2	S	8	10	29	8,100	0.15	400
CLH1005T-2N7□-S	2.7	S	8	11	30	7,700	0.15	400
CLH1005T-3N3□-S	3.3	S / K	8	11	30	6,300	0.15	400
CLH1005T-3N9□-S	3.9	S / K	8	11	31	6,100	0.20	400
CLH1005T-4N7□-S	4.7	S / K	8	11	31	5,400	0.20	400
CLH1005T-5N6□-S	5.6	S / K	8	11	31	5,100	0.20	400
CLH1005T-6N8□-S	6.8	J / K	8	11	33	4,550	0.25	400
CLH1005T-8N2□-S	8.2	J / K	8	12	32	4,100	0.30	300
CLH1005T-10N□-S	10	J / K	8	12	32	3,900	0.35	300
CLH1005T-12N□-S	12	J / K	8	12	31	3,000	0.40	300
CLH1005T-15N□-S	15	J / K	8	12	30	2,800	0.50	300
CLH1005T-18N□-S	18	J / K	8	12	29	2,500	0.55	300
CLH1005T-22N□-S	22	J / K	8	12	28	2,200	0.70	300
CLH1005T-27N□-S	27	J / K	8	12	27	2,000	0.80	300
CLH1005T-33N□-S	33	J / K	8	10	25	1,800	0.90	200
CLH1005T-39N□-S	39	J / K	8	10	25	1,600	1.00	150
CLH1005T-47N□-S	47	J / K	8	10	22	1,400	1.20	150
CLH1005T-56N□-S	56	J / K	8	10	21	1,300	1.30	150
CLH1005T-68N□-S	68	J / K	8	10	15	1,100	1.50	100
CLH1005T-82N□-S	82	J / K	8	10	13	1,000	1.60	100
CLH1005T-R10□-S	100	J / K	8	10	10	900	2.00	100
CLH1005T-R12□-S	120	J / K	8	10	-	800	2.20	100

Note:

Tolerance: S = ± 0.3 nH, J = $\pm 5\%$, K = $\pm 10\%$

Test Instruments: L/Q- Agilent E4991A, Fixture- Agilent 16197A

SRF- HP8753D

RDC- HP4338B/CH502BC



ELECTRICAL CHARACTERISTICS CLH1608-S

PART NO.	INDUCTANCE at 100MHz (nH)	TOLERANCE	Q Min.		Q TYPICAL					SRF (MHz) Min.	DC RESISTANCE (Ω) Max.	RATED CURRENT (mA) Max.	
			at 50MHz	at 100MHz	at 50MHz	at 100MHz	at 300MHz	at 500MHz	at 800MHz				
CLH1608T-1N05-S	1.0	S		8		12				60	10,000	0.10	600
CLH1608T-1N25-S	1.2	S		8		13				60	10,000	0.10	600
CLH1608T-1N55-S	1.5	S		8		13				57	8,000	0.10	600
CLH1608T-1N85-S	1.8	S		8		13				51	8,000	0.10	600
CLH1608T-2N25-S	2.2	S		8		13				46	7,200	0.10	600
CLH1608T-2N75-S	2.7	S		10		13				46	6,200	0.10	600
CLH1608T-3N3□-S	3.3	S / K		10		13				47	5,200	0.12	600
CLH1608T-3N9□-S	3.9	S / K		10		13				47	5,000	0.14	600
CLH1608T-4N7□-S	4.7	S / K		10		13				41	4,750	0.16	600
CLH1608T-5N6□-S	5.6	S / K		10		13				41	4,100	0.18	600
CLH1608T-6N8□-S	6.8	J / K		10		13				44	3,750	0.22	600
CLH1608T-8N2□-S	8.2	J / K		10		13				44	3,300	0.24	600
CLH1608T-10N□-S	10	J / K		12		13				45	3,000	0.26	600
CLH1608T-12N□-S	12	J / K		12		15				46	2,600	0.28	600
CLH1608T-15N□-S	15	J / K		12		15				48	2,500	0.32	600
CLH1608T-18N□-S	18	J / K		12		15				48	2,400	0.35	600
CLH1608T-22N□-S	22	J / K		12		17				45	2,000	0.40	500
CLH1608T-27N□-S	27	J / K		12		17				43	1,900	0.45	500
CLH1608T-33N□-S	33	J / K		12		18				39	1,600	0.55	400
CLH1608T-39N□-S	39	J / K		12		18		37			1,400	0.60	400
CLH1608T-47N□-S	47	J / K		12		18		35			1,300	0.70	400
CLH1608T-56N□-S	56	J / K		12		18		32			1,100	0.75	400
CLH1608T-62N□-S	62	J / K		12		18		34			1,050	0.85	400
CLH1608T-68N□-S	68	J / K		12		18		34			1,050	0.85	400
CLH1608T-82N□-S	82	J / K		12		18		32			900	1.00	300
CLH1608T-R10□-S	100	J / K		12		18		20			770	1.20	300
CLH1608T-R12□-S	*120	J / K	8			14		20			650	1.30	300
CLH1608T-R15□-S	*150	J / K	8			15		16			550	1.70	250
CLH1608T-R18□-S	*180	J / K	8			15		16			520	1.90	250
CLH1608T-R22□-S	*220	J / K	8			15		16			500	2.00	250
CLH1608T-R27□-S	*270	J / K	8			13		14			470	2.20	150
CLH1608T-R33□-S	*330	J / K	8			13		-			320	2.80	100
CLH1608T-R39□-S	*390	J / K	8			13		-			300	3.00	100

Note:

* at 50MHz

Tolerance: S = ± 0.3 nH, J = $\pm 5\%$, K = $\pm 10\%$

Test Instruments: L/Q- HP4291A+HP16192A

SRF- HP4291A+HP16192A

RDC- HP4338B/ CH502BC

IDC- HP4291A+HP6632A

ELECTRICAL CHARACTERISTICS CLH2012-S

PART NO.	INDUCTANCE at 100MHz (nH)	TOLERANCE	Q Min.		Q TYPICAL			SRF (MHz) Min.	DC RESISTANCE (Ω) Max.	RATED CURRENT (mA) Max.
			at 50MHz	at 100MHz	at 50MHz	at 100MHz	at 800MHz			
CLH2012T-1N0□-S	1.0	S		10		13	40	> 6000	0.10	300
CLH2012T-1N2□-S	1.2	S		10		13	40	> 6000	0.10	300
CLH2012T-1N5□-S	1.5	S		10		13	40	> 6000	0.10	300
CLH2012T-1N8□-S	1.8	S		10		13	45	> 6000	0.10	300
CLH2012T-2N2□-S	2.2	S		10		13	48	> 6000	0.10	300
CLH2012T-2N7□-S	2.7	S		12		13	48	> 6000	0.10	300
CLH2012T-3N3□-S	3.3	S / K		12		15	56	> 6000	0.13	300
CLH2012T-3N9□-S	3.9	S / K		12		15	54	5,400	0.15	300
CLH2012T-4N7□-S	4.7	S / K		12		15	50	4,500	0.20	300
CLH2012T-5N6□-S	5.6	S / K		12		15	53	4,000	0.23	300
CLH2012T-6N8□-S	6.8	J / K		15		15	51	3,650	0.25	300
CLH2012T-8N2□-S	8.2	J / K		15		15	53	3,000	0.28	300
CLH2012T-10N□-S	10	J / K		15		16	45	2,500	0.30	300
CLH2012T-12N□-S	12	J / K		15		16	48	2,450	0.35	300
CLH2012T-15N□-S	15	J / K		15		17	48	2,000	0.40	300
CLH2012T-18N□-S	18	J / K		15		17	43	1,750	0.45	300
CLH2012T-22N□-S	22	J / K		15		17	40	1,700	0.50	300
CLH2012T-27N□-S	27	J / K		15		18	38	1,550	0.55	300
CLH2012T-33N□-S	33	J / K		15		19	35	1,350	0.60	300
CLH2012T-39N□-S	39	J / K		18		21	37	1,300	0.65	300
CLH2012T-47N□-S	47	J / K		18		21	38	1,200	0.70	300
CLH2012T-56N□-S	56	J / K		18		21	31	1,150	0.75	300
CLH2012T-68N□-S	68	J / K		18		21	28	1,000	0.80	300
CLH2012T-82N□-S	82	J / K		18		22	16	850	0.90	300
CLH2012T-R10□-S	100	J / K		18		23		730	1.00	300
CLH2012T-R12□-S	* 120	J / K	13		16	22		650	1.20	300
CLH2012T-R15□-S	* 150	J / K	13		16	22		550	1.40	300
CLH2012T-R18□-S	* 180	J / K	13		16	23		500	1.80	300
CLH2012T-R22□-S	* 220	J / K	12		14	20		450	2.00	300
CLH2012T-R27□-S	* 270	J / K	12		14	20		400	2.50	200
CLH2012T-R33□-S	* 330	J / K	12		14	22		380	3.00	200
CLH2012T-R39□-S	* 390	J / K	10		14	22		330	3.50	200
CLH2012T-R47□-S	* 470	J / K	10		14	22		300	4.00	200

Note:

* at 50MHz

Tolerance: S = ± 0.3 nH, J = $\pm 5\%$, K = $\pm 10\%$

Test Instruments: L/Q- Agilent E4991A, Fixture- Agilent 16197A

SRF- HP8753D

RDC- HP4338B/CH502BC



TAPE DIMENSIONS

Unit: mm

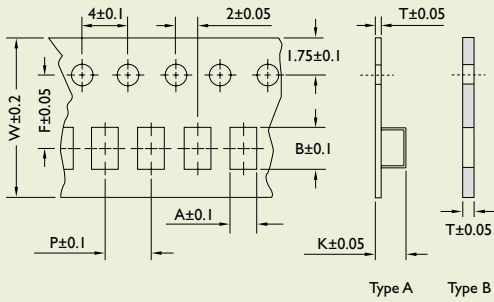

TYPE	A	B	T	W	P	F	K	TAPE TYPE
CLH1005	0.65	1.15	0.60	8	2	3.5	-	B
CLH1608	1.00	1.80	0.95	8	4	3.5	-	B
CLH201209	1.42	2.25	0.22	8	4	3.5	1.04	A/B
CLH201212	1.35	2.25	0.22	8	4	3.5	1.35	A

TAPE MATERIAL

PACKAGING QUANTITY

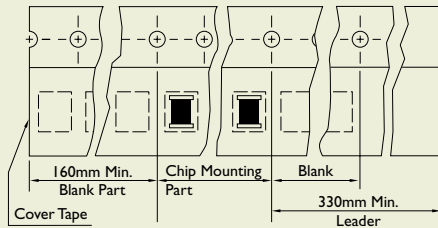

TYPE	QUANTITY/REEL
CLH1005	10,000
CLH1608	4,000
CLH201209	4,000
CLH201212	3,000

REEL DIMENSIONS

Unit: mm

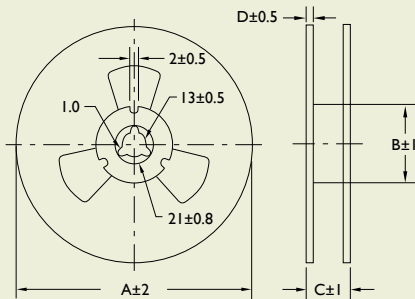

TYPE	A	B	C	D
CLH1005	178	60	12	1.5
CLH1608	178	60	12	1.5
CLH201209	178	60	12	1.5
CLH201212	178	60	12	1.5

RECOMMENDED PATTERN

Unit: mm

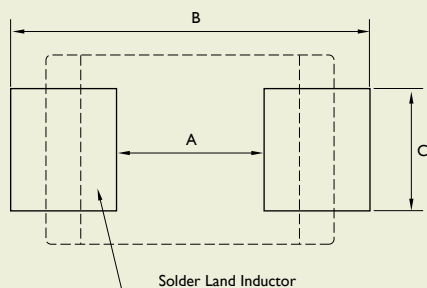

TYPE	A	B	C
CLH1005	0.40	1.2 ~ 1.4	0.40
CLH1608	0.80	2.4 ~ 3.4	0.60
CLH201209	1.20	3.0 ~ 4.0	1.00
CLH201212	1.20	3.0 ~ 4.0	1.00

SQV Series

SMD Wire Wound Chip Inductors

APPLICATIONS

- Personal, Cordless Phone
- High Freq. Communication Products
- GPS (Global Positioning System)
- Personal Computers

OUTLINE

The SQV series provides a wide inductance range, high Q value at high frequencies and low DC resistance.

FEATURES

- These miniature chip inductors wound on a special ferrite core.
- High Q value at high frequencies and low DC resistance.
- Wide Inductance Range
- Excellent solder heat resistance. Both flow and reflow soldering methods can be employed.

SHAPES AND DIMENSIONS

TYPE	A	B	C	E	F	G
SQV322520	3.2 ± 0.3	2.5 ± 0.2	2.0 ± 0.2	1.0	1.3	2.0
SQV453226	4.5 ± 0.3	3.6 ± 0.2	2.6 ± 0.2	1.5	1.5	3.0



PRODUCT IDENTIFICATION

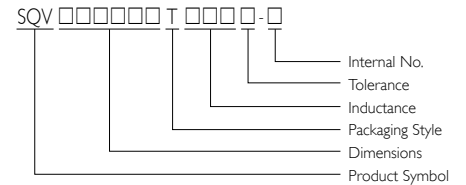

- Packaging: T = Tape and Reel
- Internal No.: N = Lead-Free

Unit: mm

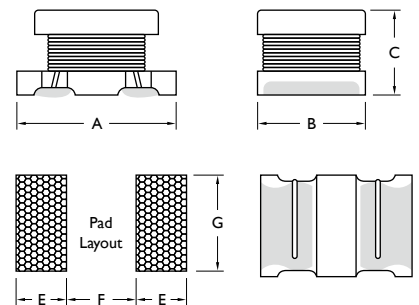



ELECTRICAL CHARACTERISTICS SQV322520

PART NO.	INDUCTANCE (μH)			QUALITY FACTOR		SRF (MHz) Min.	DC RESISTANCE (Ω) Max.	RATED CURRENT (mA) Max.
	NOMINAL	TOLERANCE	TEST	SPEC.	TEST			
	VALUE	(±%)	FREQUENCY	Min.	FREQUENCY			
SQV322520T-R10□-N	0.10	20	1 MHz	20	25.2 MHz	200	0.025	700
SQV322520T-R18□-N	0.18	20	1 MHz	20	25.2 MHz	200	0.25	650
SQV322520T-R27□-N	0.27	20	1 MHz	25	25.2 MHz	200	0.25	600
SQV322520T-R39□-N	0.39	20	1 MHz	25	25.2 MHz	200	0.25	530
SQV322520T-R56□-N	0.56	20	1 MHz	30	25.2 MHz	160	0.25	530
SQV322520T-R68□-N	0.68	20	1 MHz	30	25.2 MHz	160	0.25	470
SQV322520T-R82□-N	0.82	20	1 MHz	30	25.2 MHz	120	0.25	450
SQV322520T-1R0□-N	1.00	20	1 MHz	20	1 MHz	100	0.50	445
SQV322520T-1R2□-N	1.20	20	1 MHz	20	1 MHz	100	0.60	425
SQV322520T-1R5□-N	1.50	10 / 20	1 MHz	20	1 MHz	75	0.60	400
SQV322520T-1R8□-N	1.80	10 / 20	1 MHz	20	1 MHz	60	0.70	390
SQV322520T-2R2□-N	2.20	10 / 20	1 MHz	20	1 MHz	50	0.80	370
SQV322520T-2R7□-N	2.70	10 / 20	1 MHz	20	1 MHz	43	0.90	320
SQV322520T-3R3□-N	3.30	10 / 20	1 MHz	20	1 MHz	38	1.00	300
SQV322520T-3R9□-N	3.90	10 / 20	1 MHz	20	1 MHz	35	1.10	290
SQV322520T-4R7□-N	4.70	10 / 20	1 MHz	20	1 MHz	31	1.20	270
SQV322520T-5R6□-N	5.60	10 / 20	1 MHz	20	1 MHz	28	1.30	250
SQV322520T-6R8□-N	6.80	10 / 20	1 MHz	20	1 MHz	25	1.50	240
SQV322520T-8R2□-N	8.20	10 / 20	1 MHz	20	1 MHz	23	1.60	225
SQV322520T-100□-N	10	5 / 10	1 MHz	35	1 MHz	20	1.80	190
SQV322520T-120□-N	12	5 / 10	1 MHz	35	1 MHz	18	2.00	180
SQV322520T-150□-N	15	5 / 10	1 MHz	35	1 MHz	16	2.20	170
SQV322520T-180□-N	18	5 / 10	1 MHz	35	1 MHz	15	2.50	165
SQV322520T-220□-N	22	5 / 10	1 MHz	35	1 MHz	14	2.80	150
SQV322520T-270□-N	27	5 / 10	1 MHz	35	1 MHz	13	3.10	125
SQV322520T-330□-N	33	5 / 10	1 MHz	40	1 MHz	12	3.50	115
SQV322520T-390□-N	39	5 / 10	1 MHz	40	1 MHz	11	3.90	110
SQV322520T-470□-N	47	5 / 10	1 MHz	40	1 MHz	11	4.30	100
SQV322520T-560□-N	56	5 / 10	1 MHz	40	1 MHz	10	4.90	85
SQV322520T-680□-N	68	5 / 10	1 MHz	40	1 MHz	9.0	5.50	80
SQV322520T-820□-N	82	5 / 10	1 MHz	40	1 MHz	8.5	6.20	70
SQV322520T-101□-N	100	5 / 10	1 MHz	40	796 KHz	8.0	7.00	80
SQV322520T-121□-N	120	5 / 10	1 MHz	40	796 KHz	7.5	8.00	75
SQV322520T-151□-N	150	5 / 10	1 MHz	40	796 KHz	7.0	9.30	70
SQV322520T-181□-N	180	5 / 10	1 MHz	40	796 KHz	6.0	10.2	65
SQV322520T-221□-N	220	5 / 10	1 MHz	40	796 KHz	5.5	11.8	65
SQV322520T-271□-N	270	5 / 10	1 MHz	40	796 KHz	5.0	12.5	65
SQV322520T-331□-N	330	5 / 10	1 MHz	40	796 KHz	5.0	13.0	65
SQV322520T-391□-N	390	5 / 10	1 MHz	50	796 KHz	5.0	22.0	50
SQV322520T-471□-N	470	5 / 10	1 KHz	50	796 KHz	5.0	25.0	45
SQV322520T-561□-N	560	5 / 10	1 KHz	50	796 KHz	5.0	28.0	40

Note:

Tolerance: J = ± 5%, K = ± 10%, M = ± 20%

Test Instruments: L/Q- HP4192A LF Impedance Analyzer

SRF- HP4291A RF Impedance Analyzer

RDC- CH502BC/HP4338B

IDC- Self temperature rise shall be limited to 35 °C Max. Inductance drop 10% typ.

Soldering Heat: 260 °C 10 sec. after 150 °C Preheat Cycle for 4 Min.

Operating Temperature Range: -25 °C to +85 °C

ELECTRICAL CHARACTERISTICS SQV453226

PART NO.	INDUCTANCE (μH)			QUALITY FACTOR		SRF (MHz) Min.	DC RESISTANCE (Ω) Max.	RATED CURRENT (mA) Max.
	NOMINAL VALUE	TOLERANCE (±%)	TEST FREQUENCY	SPEC. Min.	TEST FREQUENCY			
SQV453226T-1R0□-N	1.00	20	1 MHz	20	1 MHz	120	0.20	500
SQV453226T-1R2□-N	1.20	20	1 MHz	20	1 MHz	100	0.20	500
SQV453226T-1R5□-N	1.50	20	1 MHz	20	1 MHz	85	0.30	500
SQV453226T-1R8□-N	1.80	20	1 MHz	20	1 MHz	75	0.30	500
SQV453226T-2R2□-N	2.20	20	1 MHz	20	1 MHz	62	0.30	500
SQV453226T-2R7□-N	2.70	20	1 MHz	20	1 MHz	53	0.32	500
SQV453226T-3R3□-N	3.30	20	1 MHz	20	1 MHz	47	0.35	500
SQV453226T-3R9□-N	3.90	20	1 MHz	20	1 MHz	41	0.38	500
SQV453226T-4R7□-N	4.70	10 / 20	1 MHz	30	1 MHz	38	0.40	500
SQV453226T-5R6□-N	5.60	10 / 20	1 MHz	30	1 MHz	33	0.47	500
SQV453226T-6R8□-N	6.80	10 / 20	1 MHz	30	1 MHz	31	0.50	450
SQV453226T-8R2□-N	8.20	10 / 20	1 MHz	30	1 MHz	27	0.56	450
SQV453226T-100□-N	10	5 / 10	1 MHz	35	1 MHz	23	0.56	400
SQV453226T-120□-N	12	5 / 10	1 MHz	35	1 MHz	21	0.62	380
SQV453226T-150□-N	15	5 / 10	1 MHz	35	1 MHz	19	0.73	360
SQV453226T-180□-N	18	5 / 10	1 MHz	35	1 MHz	17	0.82	340
SQV453226T-220□-N	22	5 / 10	1 MHz	35	1 MHz	15	0.94	320
SQV453226T-270□-N	27	5 / 10	1 MHz	35	1 MHz	14	1.10	300
SQV453226T-330□-N	33	5 / 10	1 MHz	35	1 MHz	12	1.20	270
SQV453226T-390□-N	39	5 / 10	1 MHz	35	1 MHz	11	1.40	240
SQV453226T-470□-N	47	5 / 10	1 MHz	35	1 MHz	10	1.50	220
SQV453226T-560□-N	56	5 / 10	1 MHz	35	1 MHz	9.3	1.70	200
SQV453226T-680□-N	68	5 / 10	1 MHz	35	1 MHz	8.4	1.90	180
SQV453226T-820□-N	82	5 / 10	1 MHz	35	1 MHz	7.5	2.20	170
SQV453226T-101□-N	100	5 / 10	1 MHz	40	796 KHz	6.8	2.50	160
SQV453226T-121□-N	120	5 / 10	1 MHz	40	796 KHz	6.2	3.00	150
SQV453226T-151□-N	150	5 / 10	1 MHz	40	796 KHz	5.5	3.70	130
SQV453226T-181□-N	180	5 / 10	1 MHz	40	796 KHz	5.0	4.50	120
SQV453226T-221□-N	220	5 / 10	1 MHz	40	796 KHz	4.5	5.40	110
SQV453226T-271□-N	270	5 / 10	1 MHz	40	796 KHz	4.0	6.80	100
SQV453226T-331□-N	330	5 / 10	1 MHz	40	796 KHz	3.6	8.20	95
SQV453226T-391□-N	390	5 / 10	1 MHz	40	796 KHz	3.3	9.70	90
SQV453226T-471□-N	470	5 / 10	1 KHz	40	796 KHz	3.0	11.8	80
SQV453226T-561□-N	560	5 / 10	1 KHz	40	796 KHz	2.7	14.5	70
SQV453226T-681□-N	680	5 / 10	1 KHz	40	796 KHz	2.5	17.5	65
SQV453226T-821□-N	820	5 / 10	1 KHz	40	796 KHz	2.2	20.5	60
SQV453226T-102□-N	1,000	5 / 10	1 KHz	40	252 KHz	2.0	25.0	50
SQV453226T-122□-N	1,200	5 / 10	1 KHz	40	252 KHz	1.8	30.0	45
SQV453226T-152□-N	1,500	5 / 10	1 KHz	40	252 KHz	1.6	37.0	40
SQV453226T-182□-N	1,800	5 / 10	1 KHz	40	252 KHz	1.5	45.0	35
SQV453226T-222□-N	2,200	5 / 10	1 KHz	40	252 KHz	1.3	50.0	30

Note:

Tolerance: J = ± 5%, K = ± 10%, M = ± 20%

Test Instruments: L/Q- HP4192A LF Impedance Analyzer

SRF- HP4291A RF Impedance Analyzer

RDC- CH502BC/HP4338B

IDC- Self temperature rise shall be limited to 35 °C Max. Inductance drop 10% typ.

Soldering Heat: 260 °C 10 sec. after 150 °C Preheat Cycle for 4 Min.

Operating Temperature Range: -25 °C to +85 °C



TAPE DIMENSIONS

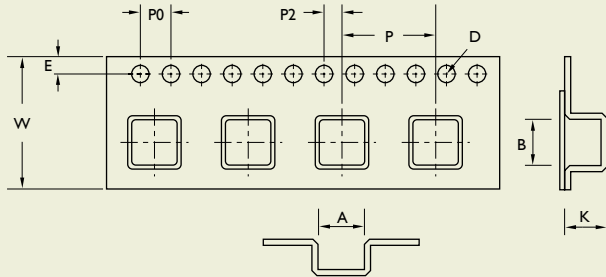

TAPE MATERIAL

Carrier Tape: Polystyrene

Cover Tape: Polyethylene

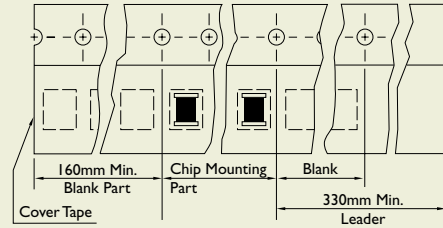

REEL DIMENSIONS

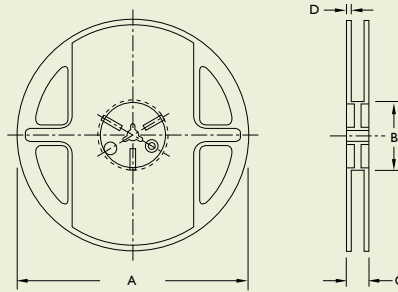

Dimensions: mm

TYPE	TAPE DIMENSIONS									REEL DIMENSIONS				QUANTITY/ REEL
	A	B	K	D	E	W	P	P0	P2	A	B	C	D	
SQV322520	2.90	3.60	2.25	1.50	1.75	8	4	4	2	178	60	9.0	1.5	2,000
SQV453226	3.60	4.90	3.00	1.50	1.75	12	8	4	2	178	60	13.2	1.5	500

SQC Series

SMD Wire Wound Chip Inductors

APPLICATIONS

Personal Computers
 Disk Drives and Computer Peripherals
 Pagers, Cordless Phones
 DC Power Supply Circuits

OUTLINE

These miniature chip inductors, SQC Series, wound on a special ferrite core and are excellent to be used as choke coil in DC power supply circuits.

FEATURES

Low DC resistance, high current capacity, and high impedance characteristics.
 Excellent solder heat resistance. Both flow and reflow soldering methods can be employed.

SHAPES AND DIMENSIONS

TYPE	A	B	C	E	F	G
SQC201609	2.0 ± 0.2	1.6 ± 0.2	0.95 ± 0.05	1.0	0.8	1.0
SQC321618	3.2 ± 0.3	1.6 ± 0.2	1.8 ± 0.2	1.2	1.3	1.5
SQC322517	3.2 ± 0.3	2.5 ± 0.2	1.55 ± 0.15	1.2	1.3	2.0
SQC322520	3.2 ± 0.3	2.5 ± 0.2	2.0 ± 0.2	1.2	1.3	2.0
SQC453226	4.5 ± 0.3	3.6 ± 0.2	2.6 ± 0.2	2.0	1.5	3.0



PRODUCT IDENTIFICATION

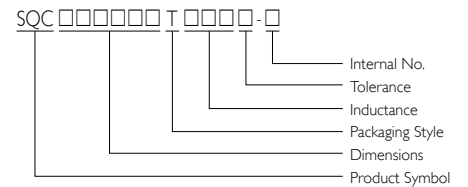

- Packaging: T = Tape and Reel
- Internal No.: N = Lead-Free

Unit: mm

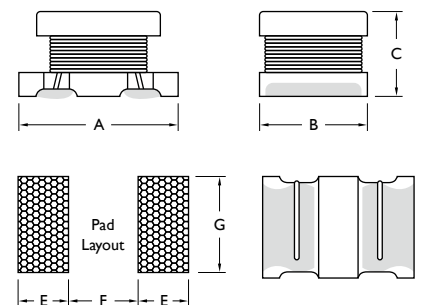



ELECTRICAL CHARACTERISTICS SQC201609

PART NO.	IMPEDANCE (μH)	TOLERANCE ($\pm\%$)	TEST FREQUENCY (MHz)	SRF (MHz) Min.	DC RESISTANCE (Ω) $\pm 30\%$	RATED CURRENT (mA) Max.
SQC201609T-1R0□-N	1.0	20	I	100	0.30	485
SQC201609T-1R5□-N	1.5	20	I	95	0.40	445
SQC201609T-2R2□-N	2.2	20	I	70	0.48	425
SQC201609T-3R3□-N	3.3	20	I	65	0.60	375
SQC201609T-4R7□-N	4.7	20	I	60	0.80	300
SQC201609T-5R6□-N	5.6	20	I	60	0.90	280
SQC201609T-6R8□-N	6.8	20	I	55	1.00	255
SQC201609T-8R2□-N	8.2	20	I	50	1.10	235
SQC201609T-10□-N	10	10 / 20	I	48	1.20	225
SQC201609T-12□-N	12	10 / 20	I	44	1.40	210
SQC201609T-15□-N	15	10 / 20	I	40	1.60	200
SQC201609T-18□-N	18	10 / 20	I	35	1.80	190
SQC201609T-22□-N	22	10 / 20	I	30	2.10	185
SQC201609T-27□-N	27	10 / 20	I	30	2.50	180
SQC201609T-33□-N	33	10 / 20	I	28	2.80	160
SQC201609T-39□-N	39	10 / 20	I	24	4.40	125
SQC201609T-47□-N	47	10 / 20	I	18	5.10	120
SQC201609T-56□-N	56	10 / 20	I	17	5.70	110
SQC201609T-68□-N	68	10 / 20	I	14	6.60	100
SQC201609T-82□-N	82	10 / 20	I	14	7.50	90

Note:

Tolerance: K = $\pm 10\%$, M = $\pm 20\%$

Tolerance of Inductance: 1.0 μH to 8.2 μH $\pm 20\%$, 10 μH to 82 μH $\pm 10\%$

Test Instruments: L/Q- HP4284A

SRF- HP4287A

RDC- CH502BC

IDC- Self temperature rise shall be limited to 40 °C Max. Inductance drop 30% typ.

Soldering Heat: 260 °C 10 sec. after 150 °C Preheat Cycle for 4 Min.

Operating Temperature Range: -40 °C to +85 °C

ELECTRICAL CHARACTERISTICS SQC321618

PART NO.	IMPEDANCE (μ H)	TOLERANCE (\pm %)	TEST FREQUENCY (MHz)	SRF (MHz) Min.	DC RESISTANCE (Ω) Max.	RATED CURRENT (mA) Max.
SQC321618T-R12□-N	0.12	20	I	250	0.112	970
SQC321618T-R22□-N	0.22	20	I	250	0.140	850
SQC321618T-R47□-N	0.47	20	I	180	0.210	700
SQC321618T-1R0□-N	1.00	20	I	100	0.364	510
SQC321618T-2R2□-N	2.20	20	I	50	0.533	430
SQC321618T-4R7□-N	4.70	10 / 20	I	31	0.845	340
SQC321618T-100□-N	10.0	5 / 10	I	20	1.690	230
SQC321618T-220□-N	22.0	5 / 10	I	14	3.900	160
SQC321618T-470□-N	47.0	5 / 10	I	10	10.40	100
SQC321618T-101□-N	100	5 / 10	I	7	15.60	80

Note:

Tolerance: J = \pm 5%, K = \pm 10%, M = \pm 20%

Test Instruments: L/Q- HP4192A LF Impedance Analyzer

SRF- HP4291A RF Impedance Analyzer

RDC- CH502BC

IDC- Self temperature rise shall be limited to 35 °C Max. Inductance drop 10% typ.

Soldering Heat: 260 °C 10 sec. after 150 °C Preheat Cycle for 4 Min.

Operating Temperature Range: -25 °C to +85 °C

ELECTRICAL CHARACTERISTICS SQC322517

PART NO.	IMPEDANCE (μ H)	TOLERANCE (\pm %)	TEST FREQUENCY (MHz)	SRF (MHz) Min.	DC RESISTANCE (Ω) \pm 30%	RATED CURRENT (mA) Max.
SQC322517T-2R2□-N	2.20	20	I	64	0.097	790
SQC322517T-3R3□-N	3.30	20	I	50	0.120	710
SQC322517T-6R8□-N	6.80	20	I	32	0.250	540
SQC322517T-100□-N	10.0	10 / 20	I	26	0.300	350
SQC322517T-220□-N	22.0	10 / 20	I	19	0.710	250
SQC322517T-101□-N	100	10 / 20	I	10	3.500	100

Note:

Tolerance: K = \pm 10%, M = \pm 20%

Tolerance of Inductance: 2.2 μ H to 6.8 μ H \pm 20%, 10 μ H to 100 μ H \pm 10%

Test Instruments: L/Q- HP4284A

SRF- HP4287A

RDC- CH502BC

IDC- Self temperature rise shall be limited to 35 °C Max. Inductance drop 10% typ.

Soldering Heat: 260 °C 10 sec. after 150 °C Preheat Cycle for 4 Min.

Operating Temperature Range: -25 °C to +85 °C



ELECTRICAL CHARACTERISTICS SQC322520

PART NO.	IMPEDANCE (μH)	TOLERANCE ($\pm\%$)	TEST FREQUENCY	SRF (MHz) Min.	DC RESISTANCE (Ω) $\pm 30\%$	RATED CURRENT (mA) Max.
SQC322520T-1R0□-N	1.00	20	1 MHz	96	0.09	1,000
SQC322520T-2R2□-N	2.20	20	1 MHz	64	0.13	600
SQC322520T-4R7□-N	4.70	20	1 MHz	43	0.20	450
SQC322520T-100□-N	10.0	20	1 MHz	26	0.44	300
SQC322520T-220□-N	22.0	10 / 20	1 MHz	19	0.71	250
SQC322520T-470□-N	47.0	10 / 20	1 MHz	15	1.30	170
SQC322520T-101□-N	100	10 / 20	1 MHz	10	3.50	100
SQC322520T-221□-N	220	10 / 20	1 MHz	6.8	8.40	70
SQC322520T-331□-N	330	10 / 20	1 MHz	5.6	10.0	60
SQC322520T-391□-N	390	10 / 20	1 MHz	5.0	17.0	60
SQC322520T-471□-N	470	10 / 20	1 KHz	5.0	19.0	60
SQC322520T-561□-N	560	10 / 20	1 KHz	5.0	22.0	60

ELECTRICAL CHARACTERISTICS SQC453226

PART NO.	IMPEDANCE (μH)	TOLERANCE ($\pm\%$)	TEST FREQUENCY	SRF (MHz) Min.	DC RESISTANCE (Ω) Max.	RATED CURRENT (mA) Max.
SQC453226T-1R0□-N	1.00	20	1 MHz	100	0.08	1,080
SQC453226T-1R5□-N	1.50	20	1 MHz	85	0.09	1,000
SQC453226T-2R2□-N	2.20	20	1 MHz	60	0.11	900
SQC453226T-3R3□-N	3.30	20	1 MHz	47	0.13	800
SQC453226T-4R7□-N	4.70	10 / 20	1 MHz	35	0.15	750
SQC453226T-6R8□-N	6.80	10 / 20	1 MHz	30	0.20	720
SQC453226T-100□-N	10.0	5 / 10	1 MHz	23	0.24	650
SQC453226T-150□-N	15.0	5 / 10	1 MHz	20	0.32	570
SQC453226T-220□-N	22.0	5 / 10	1 MHz	15	0.60	420
SQC453226T-330□-N	33.0	5 / 10	1 MHz	12	1.00	310
SQC453226T-470□-N	47.0	5 / 10	1 MHz	10	1.10	280
SQC453226T-680□-N	68.0	5 / 10	1 MHz	8.4	1.70	220
SQC453226T-101□-N	100	5 / 10	1 MHz	6.8	2.20	190
SQC453226T-151□-N	150	5 / 10	1 MHz	5.5	3.50	130
SQC453226T-221□-N	220	5 / 10	1 MHz	4.5	4.00	110
SQC453226T-331□-N	330	5 / 10	1 MHz	3.6	6.80	100
SQC453226T-471□-N	470	5 / 10	1 KHz	3.0	8.50	90

Note:

Tolerance: J = $\pm 5\%$, K = $\pm 10\%$, M = $\pm 20\%$

Test Instruments: L/Q- HP4192A LF Impedance Analyzer

SRF- HP4291A RF Impedance Analyzer

RDC- CH502BC

IDC- Self temperature rise shall be limited to 35 °C Max. Inductance drop 10% typ.

Soldering Heat: 260 °C 10 sec. after 150 °C Preheat Cycle for 4 Min.

Operating Temperature Range: -25 °C to +85 °C

TAPE DIMENSIONS

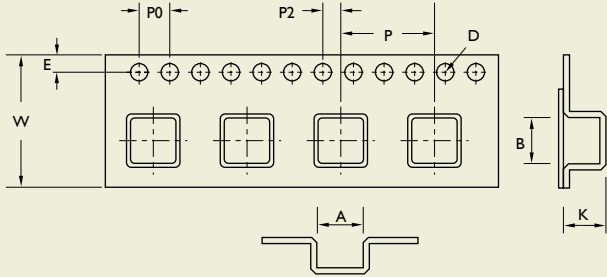

TAPE MATERIAL

Carrier Tape: Polystyrene

Cover Tape: Polyethylene

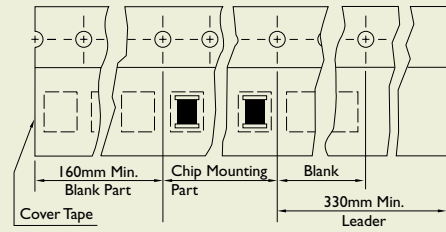

REEL DIMENSIONS

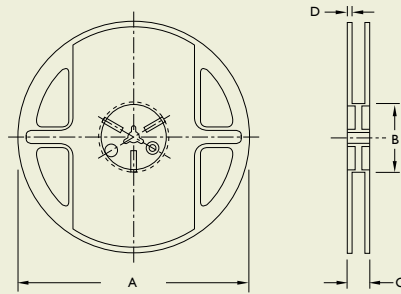

Dimensions: mm

TYPE	TAPE DIMENSIONS									REEL DIMENSIONS				QUANTITY/ REEL
	A	B	K	D	E	W	P	P0	P2	A	B	C	D	
SQC201609	1.90	2.30	1.10	1.55	1.75	8	4	4	2	178	60	9.0	1.5	3,000
SQC321618	1.85	3.55	2.05	1.50	1.75	8	4	4	2	178	60	9.0	1.5	2,000
SQC322517	2.85	3.56	1.80	1.55	1.75	8	4	4	2	178	60	9.0	1.5	2,000
SQC322520	2.90	3.60	2.25	1.50	1.75	8	4	4	2	178	60	9.0	1.5	2,000
SQC453226	3.60	4.90	3.00	1.50	1.75	12	8	4	2	178	60	13.2	1.5	500

SMD Wire Wound Chip Inductors

NL Series



PRODUCT IDENTIFICATION

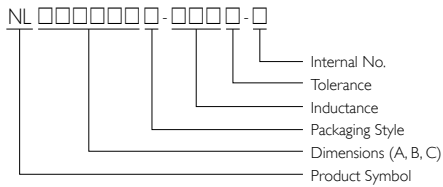

- Packaging: T = Tape and Reel, B = Bulk
- Internal No.: N = Lead-Free

APPLICATIONS

Microtelevisions, liquid crystal televisions, video cameras, portable VCRs, car radios, car stereos, thin tape radios, television tuners, mobile telephones, radios and other electronic devices.

OUTLINE

These revolutionary, highly reliable wound chip inductors for automatic mounting have been developed in response to the trend toward high density in electronic equipment.

FEATURES

Very strong solderability by reflow soldering and soldering iron or wave soldering.

Highly accurate dimensions can be mounted automatically.

Terminals are highly resistant to pull forces.

Highly resistant to mechanical shocks and pressure.

Highly reliable in environments of sudden temperature change and humidity.

Superior Q characteristics and the broadest L selections among peers.

SHAPES AND DIMENSIONS

Unit: mm

NL201614

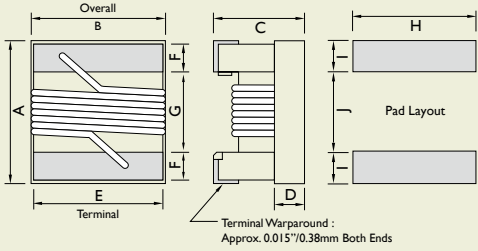

TYPE	A	B	C	D	E	F	G	H	I	J
	Max.	Max.	Max.	Ref.						
NL201614	2.4	1.72	1.52	0.7	1.27	0.5	1.02	1.78	1.02	0.76

NL252018

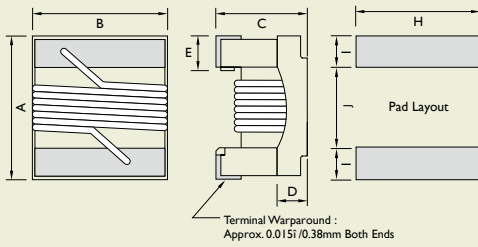

TYPE	A	B	C	D	E	F	G	H	I	J
	Max.	Max.	Max.	Ref.						
NL252018	2.92	2.5 / 2.79	2.2	0.51	0.51	-	-	2.54	1.02	1.27

NL252018 B Max: at 5N0~R10 = 2.79 mm, at R12~I01 = 2.50 mm



ELECTRICAL CHARACTERISTICS NL201614

PART NO.	INDUCTANCE (μH)	TOLERANCE ($\pm\%$)	Q Min.	TEST FREQUENCY (MHz)	SRF (MHz) Min.	DC RESISTANCE (Ω) Max.	RATED CURRENT (mA) Max.	COLOR CODING
NL201614T-R12□-N	0.12	5 / 10	25	25.20	500	0.20	600	White
NL201614T-R15□-N	0.15	5 / 10	25	25.20	450	0.25	600	Black
NL201614T-R18□-N	0.18	5 / 10	25	25.20	410	0.30	570	Brown
NL201614T-R22□-N	0.22	5 / 10	25	25.20	350	0.35	550	Red
NL201614T-R27□-N	0.27	5 / 10	25	25.20	280	0.40	530	Orange
NL201614T-R33□-N	0.33	5 / 10	25	25.20	235	0.45	510	Yellow
NL201614T-R39□-N	0.39	5 / 10	25	25.20	210	0.50	490	Green
NL201614T-R47□-N	0.47	5 / 10	25	25.20	170	0.55	470	Blue
NL201614T-R56□-N	0.56	5 / 10	25	25.20	150	0.60	450	Violet
NL201614T-R68□-N	0.68	5 / 10	25	25.20	140	0.70	420	Gray
NL201614T-R82□-N	0.82	5 / 10	25	25.20	130	0.75	400	White
NL201614T-1R0□-N	1.00	5 / 10	15	7.96	115	0.80	350	Black
NL201614T-1R2□-N	1.20	5 / 10	15	7.96	95	0.90	325	Brown
NL201614T-1R5□-N	1.50	5 / 10	15	7.96	85	1.05	300	Red
NL201614T-1R8□-N	1.80	5 / 10	15	7.96	80	1.20	270	Orange
NL201614T-2R2□-N	2.20	5 / 10	15	7.96	75	1.40	250	Yellow
NL201614T-2R7□-N	2.70	5 / 10	15	7.96	70	1.60	230	Green
NL201614T-3R3□-N	3.30	5 / 10	15	7.96	60	1.80	210	Blue
NL201614T-3R9□-N	3.90	5 / 10	15	7.96	55	2.00	190	Violet
NL201614T-4R7□-N	4.70	5 / 10	15	7.96	45	2.40	170	Gray
NL201614T-5R6□-N	5.60	5 / 10	15	7.96	40	2.70	150	White
NL201614T-6R8□-N	6.80	5 / 10	15	7.96	36	3.20	140	Black
NL201614T-8R2□-N	8.20	5 / 10	15	7.96	33	3.60	120	Brown
NL201614T-100□-N	10.0	5 / 10	15	2.52	30	4.50	110	Red
NL201614T-120□-N	12.0	5 / 10	15	2.52	25	5.70	105	Orange
NL201614T-150□-N	15.0	5 / 10	15	2.52	23	6.50	90	Yellow
NL201614T-180□-N	18.0	5 / 10	15	2.52	21	7.00	85	Green
NL201614T-220□-N	22.0	5 / 10	15	2.52	20	8.00	78	Blue
NL201614T-270□-N	27.0	5 / 10	15	2.52	18	9.00	75	Violet
NL201614T-330□-N	33.0	5 / 10	15	2.52	17	10.00	70	Gray

Note:

When ordering, please specify tolerance and packaging codes.

Tolerance: J = $\pm 5\%$, K = $\pm 10\%$

Packaging: Clear tape and reel (standard)

Test Instruments: L/Q- Agilent/HP4291A+Agilent/HP16197A

SRF- Agilent/HP4291A

RDC- CH502BC/ HP4338B

IDC- For Inductance drop 10% from its value without current

Operating Temperature Range: -25 °C to +85 °C

ELECTRICAL CHARACTERISTICS NL252018

PART NO.	INDUCTANCE (μ H)	TOLERANCE (\pm %)	Q Min.	TEST FREQUENCY (MHz)	SRF (MHz) Min.	DC RESISTANCE (Ω) Max.	RATED CURRENT (mA) Max.	COLOR CODING		
								1 st	2 nd	3 rd
NL252018T-5N0□-N	0.005	10	10	100	3,000	0.25	2,000	Black	Green	Black
NL252018T-10N□-N	0.010	10	10	100	2,500	0.25	1,800	Brown	Black	Black
NL252018T-12N□-N	0.012	10	15	100	2,400	0.26	1,700	Brown	Red	Black
NL252018T-15N□-N	0.015	10	15	100	2,300	0.28	1,600	Brown	Green	Black
NL252018T-18N□-N	0.018	10	15	100	2,200	0.30	1,550	Brown	Gray	Black
NL252018T-22N□-N	0.022	5 / 10	20	100	2,100	0.35	1,500	Red	Red	Black
NL252018T-27N□-N	0.027	5 / 10	20	100	2,000	0.40	1,450	Red	Violet	Black
NL252018T-33N□-N	0.033	5 / 10	30	100	1,600	0.42	1,400	Orange	Orange	Black
NL252018T-39N□-N	0.039	5 / 10	35	100	1,500	0.45	1,350	Orange	White	Black
NL252018T-47N□-N	0.047	5 / 10	35	100	1,400	0.50	1,300	Yellow	Violet	Black
NL252018T-56N□-N	0.056	5 / 10	35	100	1,300	0.60	1,250	Green	Blue	Black
NL252018T-68N□-N	0.068	5 / 10	35	100	1,200	0.65	1,240	Blue	Gray	Black
NL252018T-82N□-N	0.082	5 / 10	35	100	1,100	0.75	1,230	Gray	Red	Black
NL252018T-R10□-N	0.10	5 / 10	35	100	800	0.80	1,220	Brown	Black	Brown
NL252018T-R12□-N	0.12	5 / 10	30	25.20	700	0.30	900	Brown	Red	Brown
NL252018T-R15□-N	0.15	5 / 10	30	25.20	550	0.35	900	Brown	Green	Brown
NL252018T-R18□-N	0.18	5 / 10	30	25.20	500	0.40	850	Brown	Gray	Brown
NL252018T-R22□-N	0.22	5 / 10	30	25.20	450	0.50	840	Red	Red	Brown
NL252018T-R27□-N	0.27	5 / 10	30	25.20	425	0.55	830	Red	Violet	Brown
NL252018T-R33□-N	0.33	5 / 10	30	25.20	400	0.60	820	Orange	Orange	Brown
NL252018T-R39□-N	0.39	5 / 10	30	25.20	375	0.65	810	Orange	White	Brown
NL252018T-R47□-N	0.47	5 / 10	30	25.20	350	0.68	800	Yellow	Violet	Brown
NL252018T-R56□-N	0.56	5 / 10	30	25.20	325	0.75	800	Green	Blue	Brown
NL252018T-R68□-N	0.68	5 / 10	30	25.20	300	0.85	800	Blue	Gray	Brown
NL252018T-R82□-N	0.82	5 / 10	30	25.20	260	1.00	800	Gray	Red	Brown
NL252018T-1R0□-N	1.00	5 / 10	25	7.96	245	1.10	800	Brown	Black	Red
NL252018T-1R2□-N	1.20	5 / 10	25	7.96	230	1.20	790	Brown	Red	Red
NL252018T-1R5□-N	1.50	5 / 10	25	7.96	182	1.30	750	Brown	Green	Red
NL252018T-1R8□-N	1.80	5 / 10	25	7.96	135	1.45	750	Brown	Gray	Red
NL252018T-2R2□-N	2.20	5 / 10	25	7.96	105	1.55	750	Red	Red	Red
NL252018T-2R7□-N	2.70	5 / 10	25	7.96	70	1.70	740	Red	Violet	Red
NL252018T-3R3□-N	3.30	5 / 10	25	7.96	55	1.90	730	Orange	Orange	Red
NL252018T-3R9□-N	3.90	5 / 10	25	7.96	48	2.10	700	Orange	White	Red



ELECTRICAL CHARACTERISTICS NL252018

PART NO.	INDUCTANCE (μH)	TOLERANCE ($\pm\%$)	Q Min.	TEST FREQUENCY (MHz)	SRF (MHz) Min.	DC RESISTANCE (Ω) Max.	RATED CURRENT (mA) Max.	COLOR CODING		
								1 st	2 nd	3 rd
NL252018T-4R7□-N	4.70	5 / 10	25	7.96	43	2.30	650	Yellow	Violet	Red
NL252018T-5R6□-N	5.60	5 / 10	20	7.96	42	2.50	640	Green	Blue	Red
NL252018T-6R8□-N	6.80	5 / 10	20	7.96	39	2.70	630	Blue	Gray	Red
NL252018T-8R2□-N	8.20	5 / 10	20	7.96	36	3.05	600	Gray	Red	Red
NL252018T-100□-N	10.0	5 / 10	15	2.52	33	3.50	600	Brown	Black	Orange
NL252018T-120□-N	12.0	5 / 10	15	2.52	30	3.80	550	Brown	Red	Orange
NL252018T-150□-N	15.0	5 / 10	15	2.52	26	4.40	430	Brown	Green	Orange
NL252018T-180□-N	18.0	5 / 10	15	2.52	24	4.80	400	Brown	Gray	Orange
NL252018T-220□-N	22.0	5 / 10	15	2.52	22	5.50	400	Red	Red	Orange
NL252018T-270□-N	27.0	5 / 10	15	2.52	21	6.30	360	Red	Violet	Orange
NL252018T-330□-N	33.0	5 / 10	15	2.52	20	7.10	350	Orange	Orange	Orange
NL252018T-390□-N	39.0	5 / 10	10	2.52	18	9.50	330	Orange	White	Orange
NL252018T-470□-N	47.0	5 / 10	10	2.52	17	11.10	300	Yellow	Violet	Orange
NL252018T-560□-N	56.0	5 / 10	10	2.52	16	12.10	270	Green	Blue	Orange
NL252018T-680□-N	68.0	5 / 10	10	2.52	15	16.60	250	Blue	Gray	Orange
NL252018T-820□-N	82.0	5 / 10	10	2.52	13	19.00	200	Gray	Red	Orange
NL252018T-101□-N	100	5 / 10	8	0.796	12	21.00	120	Brown	Black	Yellow

Note:

When ordering, please specify tolerance and packaging codes.

Tolerance: J = $\pm 5\%$, K = $\pm 10\%$

Packaging: Clear tape and reel (standard)

Test Instruments: L/Q- Agilent/HP4291A+Agilent/HP16197A (over 1MHz) or Agilent/HP4285A+ Agilent/HP16197A (under 1MHz)

SRF- Agilent/HP8753D+Agilent/HP4291A

RDC- Digital Multimeter CH502BC/HP4338B

IDC- For Inductance drop 10% from its value without current

Operating Temperature Range: -25 °C to +85 °C

Color Coding

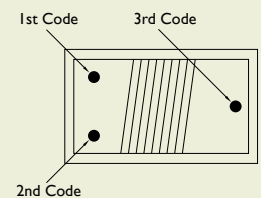

TAPE DIMENSIONS

Unit: mm

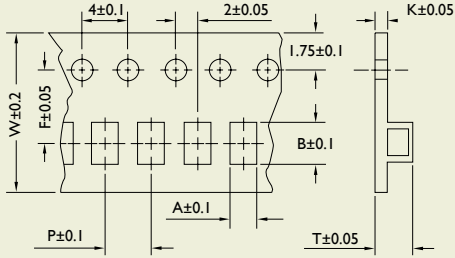

TYPE	A	B	K	W	P	F	T
NL201614	1.85	2.45	0.23	8	4	3.5	1.45
NL252018 (5N0~R10)	2.80	2.95	0.23	8	4	3.5	2.20
NL252018 (R12~101)	2.61	2.93	0.26	8	4	3.5	2.25

TAPE MATERIAL

PACKAGING QUANTITY

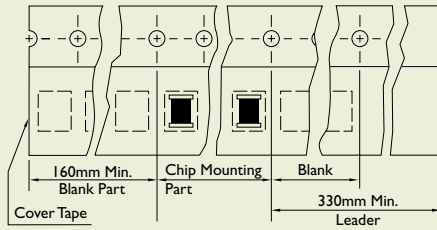

TYPE	QUANTITY/REEL
NL201614	2,000
NL252018 (5N0~R10)	2,000
NL252018 (R12~101)	2,000

REEL DIMENSIONS

Unit: mm

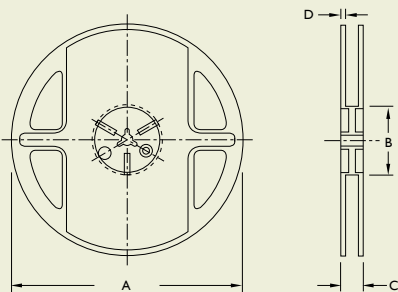

TYPE	A	B	C	D
NL201614	178	60	12	1.5
NL252018 (5N0~R10)	178	60	12	1.5
NL252018 (R12~101)	178	60	12	1.5

SMD Wire Wound Chip Inductors

NLC Series



PRODUCT IDENTIFICATION

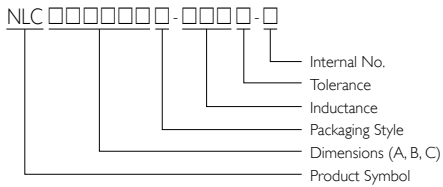

- Packaging: T = Tape and Reel; B = Bulk
- Internal No.: N = Lead-Free

APPLICATIONS

DC-DC converters such as DSC, LCD TV, game consoles, portable VCRs, conveyable telephones, and others.

OUTLINE

The characteristics of this series perform low DCR and carry large current.

These unique open type inductors offer many superior features in opposition to the molding type one of Japanese peers.

FEATURES

Very strong solderability by reflow soldering and soldering iron.

Highly accurate dimensions can be mounted automatically.

Terminals are highly resistant to pull forces.

Highly resistant to mechanical shocks and pressure.

Highly reliable in environments of sudden temperature change and humidity.

Superior IDC for DC-DC converter.

SHAPES AND DIMENSIONS

Unit: mm

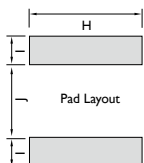
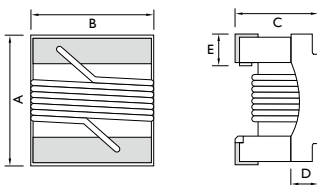

TYPE	A	B	C	D	E	H	I	J
	Max.	Max.	Max.	Ref.				
NLC252018	2.92	2.50	2.20	0.51	0.51	2.54	1.02	1.27
NLC322522	3.70	2.90	2.60	0.51	0.51	2.70	1.00	2.00

ELECTRICAL CHARACTERISTICS

PART NO.	INDUCTANCE (μ H)	TOLERANCE (\pm %)	Q Min.	TEST FREQUENCY (MHz)	SRF (MHz) Min.	DC RESISTANCE (Ω) Max.	RATED CURRENT (mA) Max.	COLOR CODING		
								1 st	2 nd	3 rd
NLC252018T-1R0□-N	1.00	5 / 10	25	7.96	300	0.34	1,500	Brown	Black	Red
NLC252018T-1R5□-N	1.50	5 / 10	25	7.96	270	0.42	1,400	Brown	Green	Red
NLC252018T-2R2□-N	2.20	5 / 10	25	7.96	140	0.50	1,200	Red	Red	Red
NLC252018T-3R3□-N	3.30	5 / 10	25	7.96	95	0.65	1,000	Orange	Orange	Red
NLC252018T-4R7□-N	4.70	5 / 10	25	7.96	90	0.80	800	Yellow	Violet	Red
NLC252018T-6R8□-N	6.80	5 / 10	25	7.96	68	1.00	730	Blue	Gray	Red
NLC252018T-100□-N	10.0	5 / 10	20	2.52	45	1.50	700	Brown	Black	Orange
NLC252018T-150□-N	15.0	5 / 10	20	2.52	40	2.20	500	Brown	Green	Orange
NLC252018T-220□-N	22.0	5 / 10	20	2.52	25	2.70	470	Red	Red	Orange
NLC252018T-330□-N	33.0	5 / 10	20	2.52	25	4.00	400	Orange	Orange	Orange
NLC252018T-470□-N	47.0	5 / 10	16	2.52	20	8.00	300	Yellow	Violet	Orange
NLC322522T-R47□-N	0.47	5 / 10	40	25.2	450	0.07	1,800	Yellow	Violet	Brown
NLC322522T-1R0□-N	1.00	5 / 10	20	7.96	100	0.08	1,500	Brown	Black	Red
NLC322522T-1R2□-N	1.20	5 / 10	20	7.96	90	0.12	1,400	Brown	Red	Red
NLC322522T-1R5□-N	1.50	5 / 10	20	7.96	80	0.13	1,125	Brown	Green	Red
NLC322522T-1R8□-N	1.80	5 / 10	20	7.96	70	0.13	970	Brown	Gray	Red
NLC322522T-2R2□-N	2.20	5 / 10	20	7.96	68	0.13	970	Red	Red	Red
NLC322522T-3R3□-N	3.30	5 / 10	20	7.96	54	0.16	837	Orange	Orange	Red
NLC322522T-4R7□-N	4.70	5 / 10	20	7.96	43	0.23	675	Yellow	Violet	Red
NLC322522T-5R6□-N	5.60	5 / 10	20	7.96	36	0.26	620	Yellow	Violet	Red
NLC322522T-6R8□-N	6.80	5 / 10	20	7.96	33	0.27	600	Blue	Gray	Red
NLC322522T-8R2□-N	8.20	5 / 10	20	7.96	30	0.32	580	Gray	Red	Red
NLC322522T-100□-N	10.0	5 / 10	15	2.52	28	0.36	520	Brown	Black	Orange
NLC322522T-150□-N	15.0	5 / 10	15	2.52	19	0.56	480	Brown	Green	Orange
NLC322522T-220□-N	22.0	5 / 10	15	2.52	16	0.77	310	Red	Red	Orange
NLC322522T-270□-N	27.0	5 / 10	15	2.52	13	1.00	280	Red	Violet	Orange
NLC322522T-330□-N	33.0	5 / 10	15	2.52	12	1.10	270	Orange	Orange	Orange
NLC322522T-470□-N	47.0	5 / 10	15	2.52	10	1.64	210	Yellow	Violet	Orange
NLC322522T-680□-N	68.0	5 / 10	15	2.52	9.0	2.80	189	Blue	Gray	Orange
NLC322522T-101□-N	100	5 / 10	15	0.796	6.0	3.70	145	Brown	Black	Yellow
NLC322522T-151□-N	150	5 / 10	15	0.796	5.0	6.10	120	Brown	Green	Yellow
NLC322522T-181□-N	180	5 / 10	15	0.796	4.0	8.00	105	Brown	Gray	Yellow
NLC322522T-221□-N	220	5 / 10	15	0.796	4.0	8.40	100	Red	Red	Yellow
NLC322522T-331□-N	330	5 / 10	15	0.796	3.5	12.3	80	Orange	Orange	Yellow
NLC322522T-471□-N	470	5 / 10	15	0.796	2.8	22.0	75	Yellow	Violet	Yellow
NLC322522T-561□-N	560	5 / 10	15	0.796	2.5	23.0	65	Green	Blue	Yellow
NLC322522T-681□-N	680	5 / 10	15	0.796	2.0	28.0	65	Blue	Gray	Yellow

Note:

When ordering, please specify tolerance and packaging codes.

Tolerance: J = \pm 5%, K = \pm 10%

Packaging: Clear tape and reel (standard)

Test Instruments: L/Q- Agilent/HP4291A+Agilent/HP16197A (over 1MHz); Agilent/HP4285A+Agilent/HP16197A (under 1MHz)

SRF- Agilent/HP4291A

RDC- CH502BC/ HP4338B

IDC- For Inductance drop 10% from its value without current

Operating Temperature Range: -25 °C to +85 °C

Color Coding

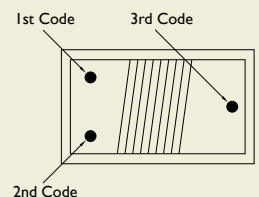



TAPE DIMENSIONS

Unit: mm

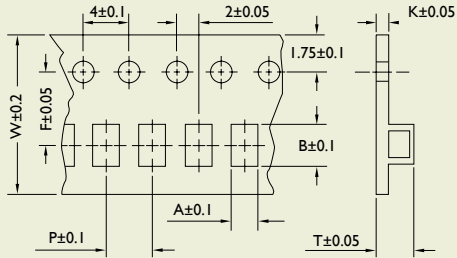

TYPE	A	B	K	W	P	F	T
NLC252018	2.61	2.93	0.23	8	4	3.5	2.25
NLC322522	2.95	3.85	0.25	12	4	3.5	2.45

TAPE MATERIAL

PACKAGING QUANTITY

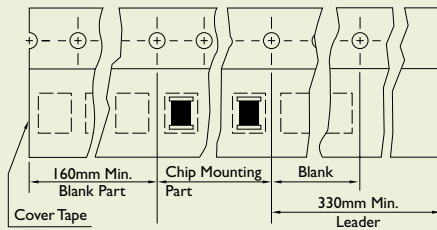

TYPE	QUANTITY/REEL
NLC252018	2,000
NLC322522	2,000

REEL DIMENSIONS

Unit: mm

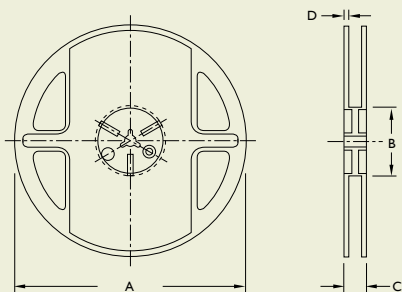

TYPE	A	B	C	D
NLC252018	178	60	12	1.5
NLC322522	178	60	16	1.4

NLV Series

SMD Wire Wound Chip Inductors

APPLICATIONS

Microtelevisions, liquid crystal televisions, video cameras, portable VCRs, car radios, car stereos, thin tape radios, television tuners, mobile telephones, radios and other electronic devices.

OUTLINE

These revolutionary, highly reliable wound chip inductors for automatic mounting have been developed in response to the trend toward high density in electronic equipment.

With metal terminals and a body of heat resistant resin, NLV Series (molded type) offers many superior features.

FEATURES

Very strong solderability by flow soldering, soldering iron or wave soldering.

Highly accurate dimensions can be mounted automatically.

Terminals are highly resistant to pull forces.

Highly resistant to mechanical shocks and pressure.

Highly reliable in environments of sudden temperature change and humidity.

Super Q characteristics.

SHAPES AND DIMENSIONS

TYPE	A	B	C	D	E	F
					Ref.	Ref.
NLV322522	3.2 ± 0.2	2.5 ± 0.2	2.2 ± 0.2	1.7 ± 0.2	0.7	1.8

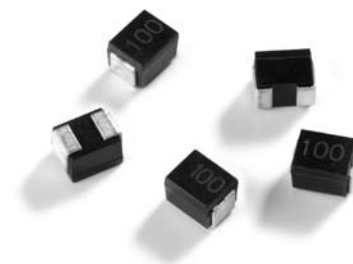

PRODUCT IDENTIFICATION

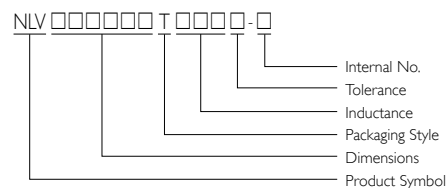

- Packaging: T = Tape and Reel, B = Bulk
- Internal No.: N = Lead-Free

Unit: mm

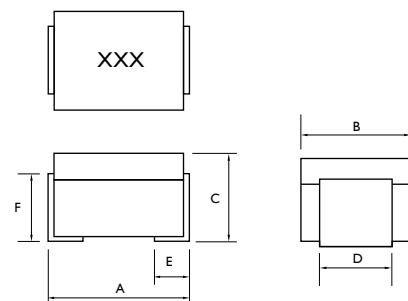



ELECTRICAL CHARACTERISTICS

PART NO.	IMPEDANCE (μH)	TOLERANCE ($\pm\%$)	Q Min.	TEST FREQUENCY (MHz)	SRF (MHz) Min.	DC RESISTANCE (Ω) Max.	RATED CURRENT (mA) Max.
NLV322522T-10N□-N	0.010	10	15	100	2,500	0.13	450
NLV322522T-12N□-N	0.012	10	17	100	2,300	0.14	450
NLV322522T-15N□-N	0.015	10	19	100	2,100	0.16	450
NLV322522T-18N□-N	0.018	10	21	100	1,900	0.18	450
NLV322522T-22N□-N	0.022	10	23	100	1,700	0.20	450
NLV322522T-27N□-N	0.027	10	23	100	1,500	0.22	450
NLV322522T-33N□-N	0.033	10	25	100	1,400	0.24	450
NLV322522T-39N□-N	0.039	10	25	100	1,300	0.27	450
NLV322522T-47N□-N	0.047	10	26	100	1,200	0.30	450
NLV322522T-56N□-N	0.056	10	26	100	1,100	0.33	450
NLV322522T-68N□-N	0.068	10	27	100	1,000	0.36	450
NLV322522T-82N□-N	0.082	10	27	100	900	0.40	450
NLV322522T-R10□-N	0.10	10	28	100	700	0.44	450
NLV322522T-R12□-N	0.12	10	30	25.2	500	0.22	450
NLV322522T-R15□-N	0.15	10	30	25.2	450	0.25	450
NLV322522T-R18□-N	0.18	10	30	25.2	400	0.28	450
NLV322522T-R22□-N	0.22	10	30	25.2	350	0.32	450
NLV322522T-R27□-N	0.27	10	30	25.2	320	0.36	450
NLV322522T-R33□-N	0.33	10	30	25.2	300	0.40	450
NLV322522T-R39□-N	0.39	10	30	25.2	250	0.45	450
NLV322522T-R47□-N	0.47	10	30	25.2	220	0.50	450
NLV322522T-R56□-N	0.56	10	30	25.2	180	0.55	450
NLV322522T-R68□-N	0.68	10	30	25.2	160	0.60	450
NLV322522T-R82□-N	0.82	10	30	25.2	140	0.65	450
NLV322522T-1R0□-N	1.0	5 / 10	30	7.96	120	0.70	400
NLV322522T-1R2□-N	1.2	5 / 10	30	7.96	100	0.75	390
NLV322522T-1R5□-N	1.5	5 / 10	30	7.96	85	0.85	370
NLV322522T-1R8□-N	1.8	5 / 10	30	7.96	80	0.90	350
NLV322522T-2R2□-N	2.2	5 / 10	30	7.96	75	1.00	320
NLV322522T-2R7□-N	2.7	5 / 10	30	7.96	70	1.10	290
NLV322522T-3R3□-N	3.3	5 / 10	30	7.96	60	1.20	260
NLV322522T-3R9□-N	3.9	5 / 10	30	7.96	55	1.30	250
NLV322522T-4R7□-N	4.7	5 / 10	30	7.96	50	1.50	220
NLV322522T-5R6□-N	5.6	5 / 10	30	7.96	45	1.60	200
NLV322522T-6R8□-N	6.8	5 / 10	30	7.96	40	1.80	180
NLV322522T-8R2□-N	8.2	5 / 10	30	7.96	35	2.00	170

Note:

Tolerance: J = $\pm 5\%$, K = $\pm 10\%$

Test Instruments: L/Q- HP4285A

SRF- HP4291A

RDC- CH502BC

IDC- HO4284A+HP42841A

ELECTRICAL CHARACTERISTICS

PART NO.	IMPEDANCE (μH)	TOLERANCE ($\pm\%$)	Q Min.	TEST FREQUENCY (MHz)	SRF (MHz) Min.	DC RESISTANCE (Ω) Max.	RATED CURRENT (mA) Max.
NLV322522T-100□-N	10	5 / 10	30	2.52	30	2.10	150
NLV322522T-120□-N	12	5 / 10	30	2.52	20	2.50	140
NLV322522T-150□-N	15	5 / 10	30	2.52	20	2.80	130
NLV322522T-180□-N	18	5 / 10	30	2.52	20	3.30	120
NLV322522T-220□-N	22	5 / 10	30	2.52	20	3.70	110
NLV322522T-270□-N	27	5 / 10	30	2.52	20	5.00	80
NLV322522T-330□-N	33	5 / 10	30	2.52	17	5.60	70
NLV322522T-390□-N	39	5 / 10	30	2.52	16	6.40	65
NLV322522T-470□-N	47	5 / 10	30	2.52	15	7	60
NLV322522T-560□-N	56	5 / 10	30	2.52	13	8	55
NLV322522T-680□-N	68	5 / 10	30	2.52	12	9	50
NLV322522T-820□-N	82	5 / 10	30	2.52	11	10	45
NLV322522T-101□-N	100	5 / 10	20	0.796	10	10	40
NLV322522T-121□-N	120	5 / 10	20	0.796	10	11	70
NLV322522T-151□-N	150	5 / 10	20	0.796	8	15	65
NLV322522T-181□-N	180	5 / 10	20	0.796	7	17	60
NLV322522T-221□-N	220	5 / 10	20	0.796	7	21	50
NLV322522T-271□-N	270	5 / 10	20	0.796	6	28	45
NLV322522T-331□-N	330	5 / 10	20	0.796	5	34	40
NLV322522T-391□-N	390	5 / 10	20	0.796	5	36	35
NLV322522T-471□-N	470	5 / 10	20	0.796	4	40	25

Note:

Tolerance: J = $\pm 5\%$, K = $\pm 10\%$

Test Instruments: L/Q- HP4285A

SRF- HP4291A

RDC- CH502BC

IDC- HO4284A+HP42841A



TAPE DIMENSIONS

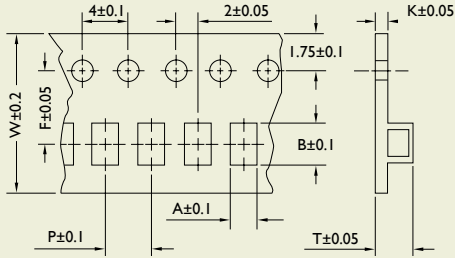

TAPE MATERIAL

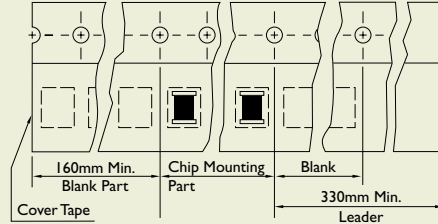

REEL DIMENSIONS

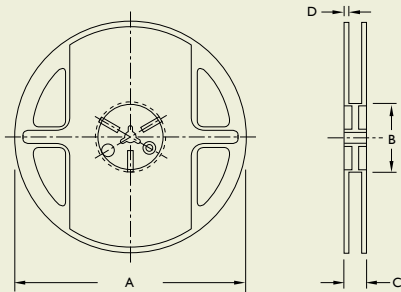

RECOMMENDED PATTERN

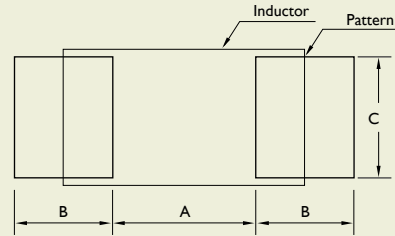

Dimensions: mm

TYPE	TAPE DIMENSIONS							RECOMMENDED PATTERN			REEL DIMENSIONS				QUANTITY/ REEL
	A	B	T	W	P	F	K	A	B	C	A	B	C	D	
NLV322522	2.96	3.60	2.40	8	4	3.50	0.23	1.6	1.2	2.0	178	60	12	1.5	2,000

NLCV Series

SMD Wire Wound Chip Inductors

APPLICATIONS

- _____ Portable Telephones
- _____ Personal Computers
- _____ HHDs
- _____ Other Electronics Appliances

OUTLINE

The characteristics of NLCV series (molded type) features low RDC and high current handling capacities.

These chip inductors are ideal for power supply applications such as PC, conveyable telephones, and so on.

FEATURES

- _____ Low RDC, Large Current Type
- _____ Best for Power Supply Lines

SHAPES AND DIMENSIONS

TYPE	A	B	C	D	E	F
					Ref.	Ref.
NLCV453232	4.5 ± 0.2	3.2 ± 0.2	3.2 ± 0.2	2.6 ± 0.1	0.8	2.5



PRODUCT IDENTIFICATION

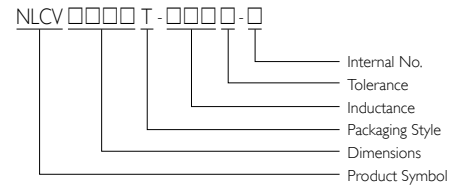

- Packaging: T = Tape and Reel, B = Bulk
- Internal No.: N = Lead-Free

Unit: mm

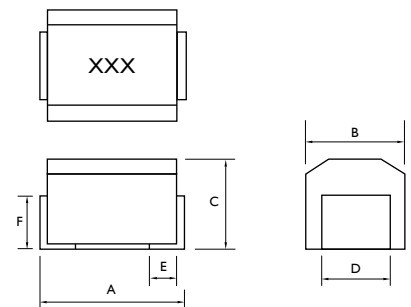



ELECTRICAL CHARACTERISTICS

PART NO.	IMPEDANCE (μ H)	TOLERANCE (\pm %)	Q Min.	TEST FREQUENCY (MHz)	SRF (MHz) Min.	DC RESISTANCE (Ω) Max.	RATED CURRENT (mA) Max.
NLCV453232T-1R0□-N	1.0	5 / 10	10	7.96	200	0.11	1,050
NLCV453232T-1R2□-N	1.2	5 / 10	10	7.96	160	0.12	1,000
NLCV453232T-1R5□-N	1.5	5 / 10	10	7.96	130	0.15	950
NLCV453232T-1R8□-N	1.8	5 / 10	10	7.96	100	0.16	900
NLCV453232T-2R2□-N	2.2	5 / 10	10	7.96	80	0.18	850
NLCV453232T-2R7□-N	2.7	5 / 10	10	7.96	60	0.20	800
NLCV453232T-3R3□-N	3.3	5 / 10	10	7.96	45	0.22	750
NLCV453232T-3R9□-N	3.9	5 / 10	10	7.96	40	0.24	700
NLCV453232T-4R7□-N	4.7	5 / 10	10	7.96	35	0.27	650
NLCV453232T-5R6□-N	5.6	5 / 10	10	7.96	30	0.30	650
NLCV453232T-6R8□-N	6.8	5 / 10	10	7.96	28	0.35	600
NLCV453232T-8R2□-N	8.2	5 / 10	10	7.96	25	0.40	600
NLCV453232T-100□-N	10	5 / 10	10	2.52	22	0.50	550
NLCV453232T-120□-N	12	5 / 10	10	2.52	21	0.60	500
NLCV453232T-150□-N	15	5 / 10	10	2.52	20	0.70	450
NLCV453232T-180□-N	18	5 / 10	10	2.52	19	0.80	400
NLCV453232T-220□-N	22	5 / 10	10	2.52	18	0.90	370
NLCV453232T-270□-N	27	5 / 10	10	2.52	16	1.20	330
NLCV453232T-330□-N	33	5 / 10	10	2.52	14	1.40	300
NLCV453232T-390□-N	39	5 / 10	10	2.52	12	1.60	280
NLCV453232T-470□-N	47	5 / 10	10	2.52	11.5	1.90	260
NLCV453232T-560□-N	56	5 / 10	10	2.52	11.0	2.20	240
NLCV453232T-680□-N	68	5 / 10	10	2.52	10.0	2.60	220
NLCV453232T-820□-N	82	5 / 10	10	2.52	9.0	3.50	200
NLCV453232T-101□-N	100	5 / 10	20	0.796	8.0	4.00	180
NLCV453232T-121□-N	120	5 / 10	20	0.796	7.5	4.50	160
NLCV453232T-151□-N	150	5 / 10	20	0.796	7.0	6.50	140
NLCV453232T-181□-N	180	5 / 10	20	0.796	6.5	7.50	120
NLCV453232T-221□-N	220	5 / 10	20	0.796	5.5	9.00	120
NLCV453232T-271□-N	270	5 / 10	20	0.796	5.0	11.0	100
NLCV453232T-331□-N	330	5 / 10	20	0.796	4.0	13.0	90

Note:

Tolerance: J = \pm 5%, K = \pm 10%

Test Instruments: L/Q- HP4285A

SRF- HP4291A

RDC- CH502BC

IDC- HO4284A+HP42841A

TAPE DIMENSIONS

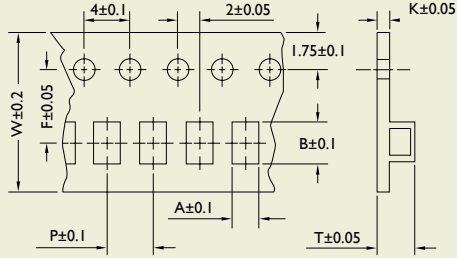

TAPE MATERIAL

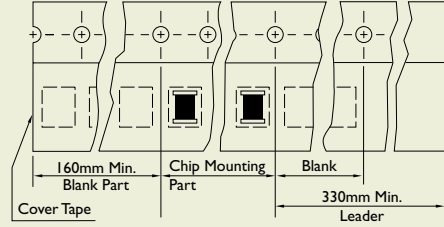

REEL DIMENSIONS

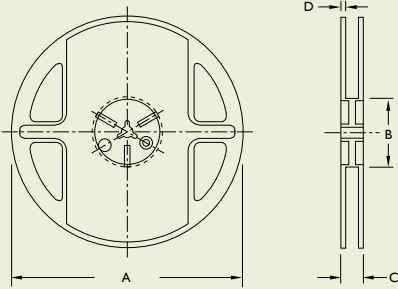

RECOMMENDED PATTERN

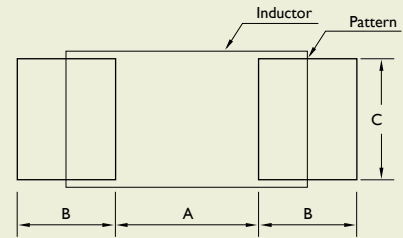

Dimensions: mm

TYPE	TAPE DIMENSIONS							RECOMMENDED PATTERN			REEL DIMENSIONS				QUANTITY/ REEL
	A	B	T	W	P	F	K	A	B	C	A	B	C	D	
NLCV453232	3.30	5.00	3.50	12	8	5.50	0.30	3.0	1.5	2.8	178	60	16	1.4	500

SMD Wire Wound Chip Inductors

LS Series



PRODUCT IDENTIFICATION

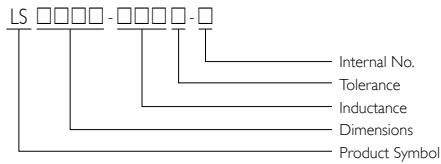

■ Internal No.: N = Lead-Free

APPLICATIONS

Telecom and datacom applications such as xDSL, Cable Modem, Set-top Box, CATV filter/tuner, wireless LAN and so on.

OUTLINE

LS Series is the newest combo in open type ferrite wire wound chip inductors.

The wire wound ferrite construction provides higher SRF, lower DCR and superior Q values than other ferrite chip inductors.

FEATURES

Lead-free electrodes.

Very strong solderability by reflow soldering and soldering iron or wave soldering.

Highly accurate dimensions can be mounted automatically.

Terminals are highly resistant to pull forces.

Highly resistant to mechanical shocks and pressure.

Highly reliable in environments of sudden temperature change and humidity.

Lowest DCR & better Q value in ferrite series.

SHAPES AND DIMENSIONS

Unit: mm

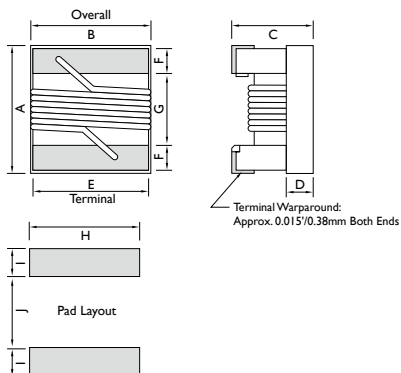

TYPE	A	B	C	D	E	F	G	H	I	J
	Max.	Max.	Max.							
LS0603	1.80	1.25	1.02	0.38	0.76	0.33	0.86	1.02	0.64	0.64
LS0805	2.40	1.72	1.52	0.70	1.27	0.50	1.02	1.78	1.02	0.76
LS1008	2.99	2.50	2.20	0.70	2.03	0.51	1.52	2.54	1.02	1.27

ELECTRICAL CHARACTERISTICS LS0603

PART NO.	INDUCTANCE (nH)	TOLERANCE (±%)	Q TYPICAL	TEST FREQUENCY (MHz)	SRF (MHz) Min.	DC RESISTANCE (Ω) Max.	IDC (mA) Max.	COLOR CODING
LS0603-47N□-N	47	5 / 10	17	7.90	1,700	0.075	1,500	Black
LS0603-72N□-N	72	5 / 10	17	7.90	1,700	0.12	1,500	Brown
LS0603-R10□-N	100	5 / 10	17	7.90	1,650	0.13	1,500	Red
LS0603-R12□-N	120	5 / 10	17	7.90	1,350	0.15	1,500	Orange
LS0603-R15□-N	150	5 / 10	17	7.90	1,350	0.15	1,450	Yellow
LS0603-R18□-N	180	5 / 10	17	7.90	1,150	0.15	1,400	Green
LS0603-R22□-N	220	5 / 10	17	7.90	1,050	0.16	1,350	Blue
LS0603-R24□-N	240	5 / 10	17	7.90	1,050	0.19	1,300	Violet
LS0603-R27□-N	270	5 / 10	17	7.90	1,050	0.30	1,050	Gray
LS0603-R33□-N	330	5 / 10	17	7.90	850	0.46	1,200	White
LS0603-R39□-N	390	5 / 10	17	7.90	810	0.51	1,200	Black
LS0603-R47□-N	470	5 / 10	17	7.90	720	0.62	1,050	Brown
LS0603-R56□-N	560	5 / 10	17	7.90	600	0.44	850	Red
LS0603-R68□-N	680	5 / 10	17	7.90	600	0.52	850	Orange
LS0603-R78□-N	780	5 / 10	17	7.90	460	0.83	850	Yellow
LS0603-R82□-N	820	5 / 10	17	7.90	480	0.69	750	Green
LS0603-1R0□-N	1,000	5 / 10	18	7.90	310	0.81	600	Blue
LS0603-1R2□-N	1,200	5 / 10	17	7.90	270	0.87	550	Violet
LS0603-1R5□-N	1,500	5 / 10	17	7.90	270	1.06	540	Gray
LS0603-1R8□-N	1,800	5 / 10	17	7.90	230	1.10	520	White
LS0603-2R2□-N	2,200	5 / 10	17	7.90	140	1.20	500	Black
LS0603-2R7□-N	2,700	5 / 10	17	7.90	105	1.50	480	Brown
LS0603-3R3□-N	3,300	5 / 10	17	7.90	84	1.50	440	Red
LS0603-3R9□-N	3,900	5 / 10	17	7.90	80	1.60	430	Orange
LS0603-4R7□-N	4,700	5 / 10	18	7.90	69	2.10	420	Yellow
LS0603-5R6□-N	5,600	5 / 10	18	7.90	65	2.60	400	Green
LS0603-6R8□-N	6,800	5 / 10	19	7.90	55	3.10	400	Blue
LS0603-7R8□-N	7,800	5 / 10	17	7.90	47	3.50	400	Violet
LS0603-8R2□-N	8,200	5 / 10	17	7.90	42	3.60	400	Gray
LS0603-100□-N	10,000	5 / 10	19	7.90	40	4.80	300	White

Note:

When ordering, please specify tolerance and packaging codes.

Tolerance: J = ± 5%, K = ± 10%

Packaging: Clear tape and reel (standard)

Test Instruments: L/Q- Agilent/HP4291A+Agilent/HP16197A

SRF- Agilent/HP4291A

RDC- CH502BC/ HP4338B

IDC- For Inductance drop 10% from its value without current

Operating Temperature Range: -25 °C to +85 °C



ELECTRICAL CHARACTERISTICS LS0805

PART NO.	INDUCTANCE (nH)	TOLERANCE (±%)	Q TYPICAL	TEST	SRF (MHz) Min.	DC RESISTANCE (Ω) Max.	IDC (mA) Max.	COLOR CODING
				FREQUENCY (MHz)				
LS0805-78N□-N	78	5 / 10	19	7.90	1,440	0.06	2,000	Black
LS0805-110□-N	110	5 / 10	19	7.90	1,200	0.07	2,000	Brown
LS0805-470□-N	470	5 / 10	19	7.90	480	0.40	800	Red
LS0805-680□-N	680	5 / 10	20	7.90	480	0.40	800	Orange
LS0805-1R0□-N	1,000	5 / 10	20	7.90	400	0.69	700	Yellow
LS0805-1R5□-N	1,500	5 / 10	20	7.90	330	0.83	700	Green
LS0805-1R8□-N	1,800	5 / 10	20	7.90	300	1.00	650	Blue
LS0805-2R2□-N	2,200	5 / 10	20	7.90	250	1.10	650	Violet
LS0805-2R7□-N	2,700	5 / 10	23	7.90	200	1.25	650	Gray
LS0805-3R3□-N	3,300	5 / 10	23	7.90	160	1.45	650	White
LS0805-3R9□-N	3,900	5 / 10	23	7.90	90	1.50	600	Black
LS0805-4R7□-N	4,700	5 / 10	20	7.90	70	1.60	530	Brown
LS0805-5R6□-N	5,600	5 / 10	20	7.90	65	1.70	500	Red
LS0805-6R8□-N	6,800	5 / 10	20	7.90	45	1.95	470	Orange
LS0805-8R2□-N	8,200	5 / 10	16	2.50	45	2.10	450	Yellow
LS0805-100□-N	10,000	5 / 10	16	2.50	40	2.40	400	Green
LS0805-120□-N	12,000	5 / 10	16	2.50	38	3.20	360	Red
LS0805-150□-N	15,000	5 / 10	16	2.50	35	3.55	350	Blue
LS0805-180□-N	18,000	5 / 10	16	2.50	25	4.90	300	Orange
LS0805-220□-N	22,000	5 / 10	16	2.50	20	5.45	270	Violet
LS0805-270□-N	27,000	5 / 10	16	2.50	19	7.80	240	Gray
LS0805-470□-N	47,000	5 / 10	16	2.50	15	14.5	180	Brown

ELECTRICAL CHARACTERISTICS LS1008

PART NO.	INDUCTANCE (μH)	TOLERANCE (±%)	Q TYPICAL			TEST FREQUENCY (MHz)	SRF (MHz) Min.	DC RESISTANCE (Ω) Max.	IDC (mA) Max.	COLOR CODING		
			7.9MHz	25MHz	50MHz					1 st	2 nd	3 rd
LS1008-1R2□-N	1.2	5 / 10	35	47	55	7.90	350	0.50	1,200	Brown	Red	Red
LS1008-1R5□-N	1.5	5 / 10	38	53	58	7.90	300	0.65	1,200	Brown	Green	Red
LS1008-1R8□-N	1.8	5 / 10	34	47	54	7.90	280	0.75	1,050	Brown	Gray	Red
LS1008-2R2□-N	2.2	5 / 10	34	43	48	7.90	250	0.90	950	Red	Red	Red
LS1008-2R7□-N	2.7	5 / 10	38	49	51	7.90	200	1.00	950	Red	Violet	Red
LS1008-3R3□-N	3.3	5 / 10	42	57	58	7.90	200	1.15	900	Orange	Orange	Red
LS1008-3R9□-N	3.9	5 / 10	37	46	47	7.90	170	1.25	850	Orange	White	Red
LS1008-4R7□-N	4.7	5 / 10	37	43	38	7.90	130	1.35	700	Yellow	Violet	Red
LS1008-5R6□-N	5.6	5 / 10	36	40	29	7.90	110	1.45	700	Green	Blue	Red
LS1008-6R8□-N	6.8	5 / 10	33	39	33	7.90	105	1.60	600	Blue	Gray	Red
LS1008-8R2□-N	8.2	5 / 10	40	43	28	7.90	90	1.80	550	Gray	Red	Red
LS1008-100□-N	10	5 / 10	40	41	25	7.90	85	2.40	500	Brown	Black	Orange

Note:

When ordering, please specify tolerance and packaging codes.

Tolerance: J = ± 5%, K = ± 10%

Packaging: Clear tape and reel (standard)

Test Instruments: L/Q- Agilent/HP4291A+Agilent/HPI 6197A

SRF- Agilent/HP4291A

RDC- CH502BC/ HP4338B

IDC- For Inductance drop 10% from its value without current

Operating Temperature Range: -25 °C to +85 °C

Color Coding

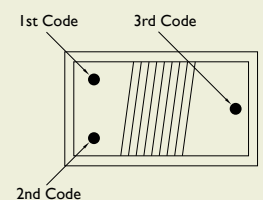

TAPE DIMENSIONS

Unit: mm

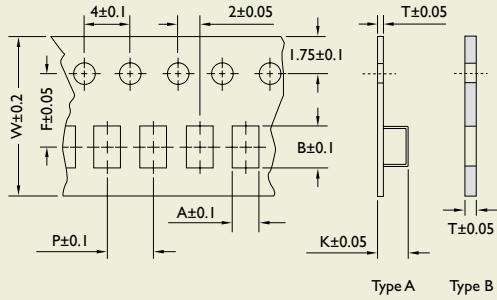

TYPE	A	B	T	W	P	F	K	TAPE TYPE
LS0603	1.23	1.90	0.97	8	4	3.50	-	B
LS0805	1.60	2.42	0.22	8	4	3.50	1.45	A
LS1008	2.61	2.93	0.26	8	4	3.50	2.25	A

TAPE MATERIAL

PACKAGING QUANTITY

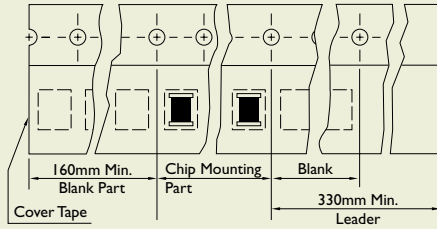

TYPE	QUANTITY/REEL
LS0603	4,000
LS0805	2,000
LS1008	2,000

REEL DIMENSIONS

Unit: mm

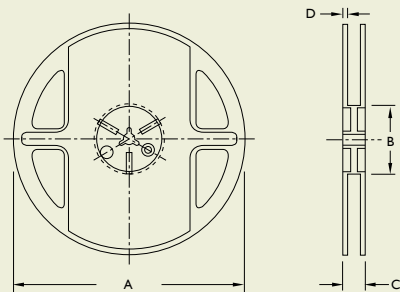

TYPE	A	B	C	D
LS0603	178	60	12	1.5
LS0805	178	60	12	1.5
LS1008	178	60	12	1.5

SMD Wire Wound Chip Inductors

LT Series



PRODUCT IDENTIFICATION

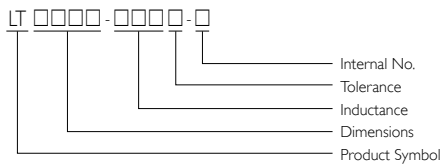

■ Internal No.: N = Lead-Free

APPLICATIONS

Boost IC for tiny panels of C-STN, TFT-LCD and OLED in backlight.

Buck/Boost IC using in DC to DC converters.

LC filter in power as well as signal lines.

OUTLINE

LT series is the newest open type ferrite wire wound chip inductors.

This wire wound ferrite construction provides thinner thickness for low profile applications.

FEATURES

At just 1.05mm high, these are one of Yageo lowest profile surface mount inductors.

Their wire wound ferrite design provides lower DCR, higher current ratings and exceptional Q values.

They come in inductance values from 0.12 μ H to 39 μ H.

SHAPES AND DIMENSIONS

Unit: mm

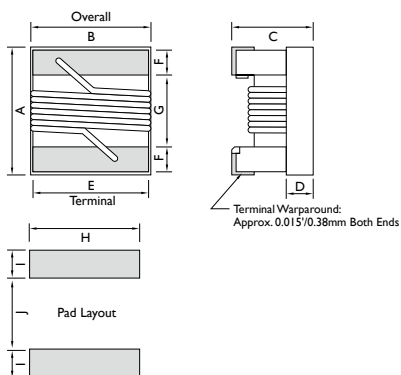

TYPE	A	B	C	D	E	F	G	H	I	J
	Max.	Max.	Max.	Ref.						
LT0805	2.40	1.85	1.05	0.70	1.27	0.50	1.02	1.78	1.02	0.76
LT1210	3.75	3.10	1.05	0.65	2.35	0.65	1.80	2.70	1.00	2.00

ELECTRICAL CHARACTERISTICS LT0805

PART NO.	INDUCTANCE (nH)	TOLERANCE (±%)	Q Min.	TEST FREQUENCY (MHz)	SRF (MHz) Min.	DC RESISTANCE (Ω) Max.	IDC (mA) Max.	COLOR CODING
LT0805-R12□-N	120	5 / 10	22	25.2	1,500	0.33	1,200	Black
LT0805-R15□-N	150	5 / 10	22	25.2	1,100	0.33	1,200	Brown
LT0805-R18□-N	180	5 / 10	22	25.2	1,100	0.36	1,100	Red
LT0805-R22□-N	220	5 / 10	22	25.2	1,100	0.39	1,100	Orange
LT0805-R27□-N	270	5 / 10	22	25.2	950	0.43	1,050	Yellow
LT0805-R33□-N	330	5 / 10	22	25.2	650	0.46	900	Green
LT0805-R39□-N	390	5 / 10	22	25.2	640	0.48	850	Blue
LT0805-R47□-N	470	5 / 10	22	25.2	570	0.65	800	Violet
LT0805-R56□-N	560	5 / 10	22	25.2	540	0.67	770	Gray
LT0805-R68□-N	680	5 / 10	22	25.2	500	0.73	750	White
LT0805-R82□-N	820	5 / 10	22	25.2	480	0.85	730	Black
LT0805-1R0□-N	1,000	5 / 10	15	7.96	470	0.87	720	Brown
LT0805-1R2□-N	1,200	5 / 10	15	7.96	450	0.97	690	Red
LT0805-1R5□-N	1,500	5 / 10	15	7.96	400	1.10	670	Orange
LT0805-1R8□-N	1,800	5 / 10	15	7.96	340	1.15	650	Yellow
LT0805-2R2□-N	2,200	5 / 10	15	7.96	265	1.28	630	Green
LT0805-2R7□-N	2,700	5 / 10	15	7.96	235	1.40	620	Blue
LT0805-3R3□-N	3,300	5 / 10	15	7.96	190	1.62	580	Violet
LT0805-3R9□-N	3,900	5 / 10	15	7.96	180	1.75	570	Gray
LT0805-4R7□-N	4,700	5 / 10	15	7.96	160	1.95	550	White
LT0805-5R6□-N	5,600	5 / 10	15	7.96	120	2.14	540	Black
LT0805-6R8□-N	6,800	5 / 10	15	7.96	45	2.28	520	Brown
LT0805-8R2□-N	8,200	5 / 10	15	7.96	42	2.55	500	Red
LT0805-100□-N	10,000	5 / 10	10	2.52	38	2.70	450	Orange
LT0805-120□-N	12,000	5 / 10	10	2.52	33	4.20	400	Yellow
LT0805-150□-N	15,000	5 / 10	10	2.52	30	4.80	380	Green
LT0805-180□-N	18,000	5 / 10	10	2.52	25	5.74	300	Blue
LT0805-220□-N	22,000	5 / 10	10	2.52	23	7.75	260	Violet
LT0805-270□-N	27,000	5 / 10	10	2.52	21	10.0	230	Gray
LT0805-330□-N	33,000	5 / 10	10	2.52	16	13.5	200	White
LT0805-390□-N	39,000	5 / 10	10	2.52	15	16.0	190	Black

Note:

When ordering, please specify tolerance and packaging codes.

Tolerance: J = ± 5%, K = ± 10%

Packaging: Clear tape and reel (standard)

Test Instruments: L/Q- Agilent/HP4291A+Agilent/HPI6197A

SRF- Agilent/HP4291A

RDC- CH502BC/ HP4338B

IDC- For Inductance drop 10% from its value without current

Operating Temperature Range: -25 °C to +85 °C



ELECTRICAL CHARACTERISTICS LT1210

PART NO.	INDUCTANCE (nH)	TOLERANCE (±%)	Q TYPICAL	TEST FREQUENCY (MHz)	SRF (MHz) Min.	DC RESISTANCE (Ω) Max.	IDC (mA) Max.	COLOR CODING		
								1 st	2 nd	3 rd
LT1210-1R0□-N	1,000	5 / 10	20	7.96	350	0.45	1,500	Brown	Black	Red
LT1210-1R2□-N	1,200	5 / 10	20	7.96	330	0.49	1,300	Brown	Red	Red
LT1210-1R5□-N	1,500	5 / 10	20	7.96	310	0.68	1,200	Brown	Green	Red
LT1210-1R8□-N	1,800	5 / 10	20	7.96	290	0.72	1,150	Brown	Gray	Red
LT1210-2R2□-N	2,200	5 / 10	20	7.96	270	1.02	1,020	Red	Red	Red
LT1210-2R7□-N	2,700	5 / 10	20	7.96	265	1.15	1,000	Red	Violet	Red
LT1210-3R3□-N	3,300	5 / 10	20	7.96	195	1.20	970	Orange	Orange	Red
LT1210-3R9□-N	3,900	5 / 10	20	7.96	170	1.35	910	Orange	White	Red
LT1210-4R7□-N	4,700	5 / 10	20	7.96	155	1.48	880	Yellow	Violet	Red
LT1210-5R6□-N	5,600	5 / 10	20	7.96	125	1.64	820	Green	Blue	Red
LT1210-6R8□-N	6,800	5 / 10	20	7.96	110	1.68	750	Blue	Gray	Red
LT1210-8R2□-N	8,200	5 / 10	20	7.96	100	1.88	700	Gray	Red	Red
LT1210-100□-N	10,000	5 / 10	16	2.52	85	2.90	610	Brown	Black	Orange
LT1210-120□-N	12,000	5 / 10	16	2.52	70	3.05	540	Brown	Red	Orange
LT1210-150□-N	15,000	5 / 10	16	2.52	65	3.45	500	Brown	Green	Orange
LT1210-180□-N	18,000	5 / 10	16	2.52	55	4.79	420	Brown	Gray	Orange
LT1210-220□-N	22,000	5 / 10	16	2.52	50	5.20	350	Red	Red	Orange

Note:

When ordering, please specify tolerance and packaging codes.

Tolerance: J = ± 5%, K = ± 10%

Packaging: Clear tape and reel (standard)

Test Instruments: L/Q- Agilent/HP4291A+Agilent/HPI 6197A

SRF- Agilent/HP4291A

RDC- CH502BC/ HP4338B

IDC- For Inductance drop 10% from its value without current

Operating Temperature Range: -25 °C to +85 °C

Color Coding

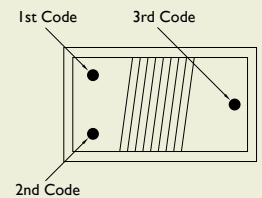

TAPE DIMENSIONS

Unit: mm

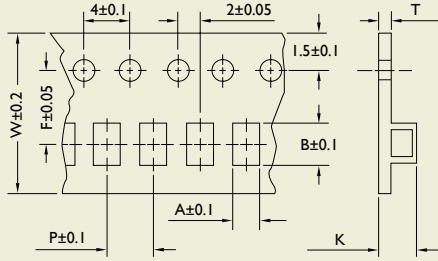

TYPE	A	B	T	W	P	F	K
LT0805	1.85	2.45	0.23	8	4	3.5	1.0
LT1210	3.05	3.70	0.25	12	4	5.5	1.1

TAPE MATERIAL

PACKAGING QUANTITY

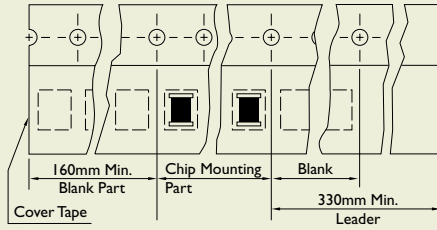

TYPE	QUANTITY/REEL
LT0805	2,000
LT1210	2,000

REEL DIMENSIONS

Unit: mm

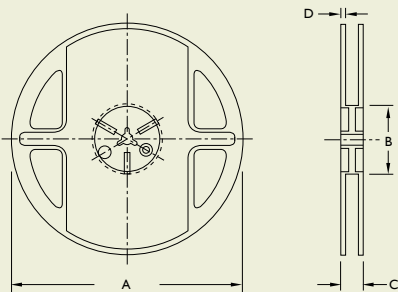

TYPE	A	B	C	D
LT0805	178	60	12	1.5
LT1210	178	60	12	1.5

SMD Wire Wound Chip Inductors

LD Series



PRODUCT IDENTIFICATION

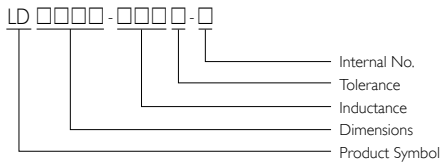

■ Internal No.: N = Lead-Free

APPLICATIONS

DSC, DVC, MD, PDA

Portable Digital Equipment

OUTLINE

LD series is the newest open type ferrite wire wound chip inductors.

This wire wound ferrite construction provides lower DCR than other open type inductors.

FEATURES

Miniature SMD type 0805 wire-wound chip inductors with low DC resistance.

Wide inductance range (1 μ H to 100 μ H).

SHAPES AND DIMENSIONS

Unit: mm

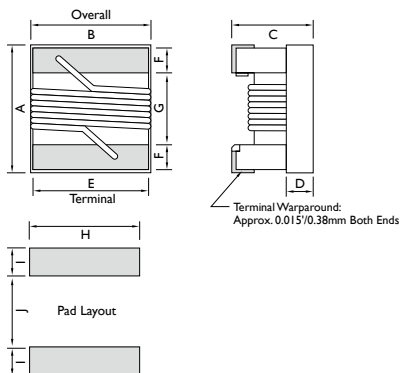

TYPE	A	B	C	D	E	F	G	H	I	J
	Max.	Max.	Max.							
LD0805	2.40	1.72	1.52	0.70	1.27	0.50	1.00	1.78	1.02	0.76

ELECTRICAL CHARACTERISTICS

PART NO.	INDUCTANCE (μ H)	TOLERANCE (\pm %)	Q TYPICAL	TEST FREQUENCY (MHz)	SRF (MHz) Min.	DC RESISTANCE (Ω) \pm 30%	IDC (mA)	COLOR CODING
LD0805-1R0□-N	1.0	10 / 20	18	7.96	100	0.10	800	Black
LD0805-1R5□-N	1.5	10 / 20	18	7.96	90	0.18	650	Brown
LD0805-2R2□-N	2.2	10 / 20	18	7.96	70	0.24	550	Red
LD0805-3R3□-N	3.3	10 / 20	18	7.96	55	0.30	450	Orange
LD0805-4R7□-N	4.7	10 / 20	18	7.96	50	0.47	360	Yellow
LD0805-6R8□-N	6.8	10 / 20	24	7.96	60	0.75	290	Green
LD0805-100□-N	10	10 / 20	18	2.52	25	0.90	290	Blue
LD0805-150□-N	15	10 / 20	18	2.52	25	1.60	230	Violet
LD0805-220□-N	22	10 / 20	18	2.52	17	1.95	190	Gray
LD0805-330□-N	33	10 / 20	17	2.52	15	2.60	120	White
LD0805-470□-N	47	10 / 20	17	2.52	11	3.90	95	Black
LD0805-680□-N	68	10 / 20	17	2.52	11	5.50	95	Brown
LD0805-101□-N	100	10 / 20	12	1.00	9	9.00	70	Red

Note:

When ordering, please specify tolerance and packaging codes.

Tolerance: K = \pm 10%, M = \pm 20%

Packaging: Clear tape and reel (standard)

Test Instruments: L/Q- Agilent/HP4291A+Agilent/HP16197A (over 1MHz) or Agilent/HP4285A (under 1MHz)

SRF- Agilent/HP4291A

RDC- CH502BC/ HP4338B

IDC- For Inductance drop 10% from its value without current

Operating Temperature Range: -25 °C to +85 °C



TAPE DIMENSIONS

Unit: mm

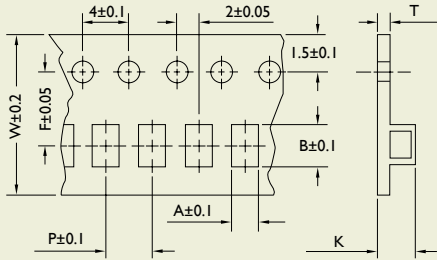

TYPE	A	B	T	W	P	F	K
LD0805	1.60	2.42	0.22	8	4	3.50	1.45

TAPE MATERIAL

PACKAGING QUANTITY

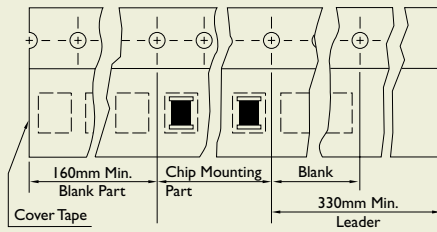

TYPE	QUANTITY/REEL
LD0805	2,000

REEL DIMENSIONS

Unit: mm

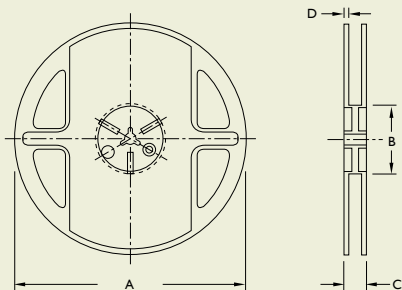

TYPE	A	B	C	D
LD0805	178	60	12	1.5

PS Series

SMD Wire Wound Chip Inductors

APPLICATIONS

Notebook Computers

PC Cards

Wireless Communication

Handheld Devices

OUTLINE

PS series is the newest shielding type ferrite wire wound chip inductors.

This wire wound ferrite construction provides extremely low DCR and high rating current.

FEATURES

Shielded power inductors

Only 2.94 mm high

The specially designed ferrite cover provides magnetic shielding.

The best possible surface for pick and place handling.

SHAPES AND DIMENSIONS

TYPE	A	B	C	D	E	F	G	H	I	J
	Max.	Max.	Max.							
PS1008	3.81	3.81	2.94 / 3.05	2.20	2.54	2.03	0.51	2.54	1.02	1.27

C = 2.94⁺⁰ mm at 1R0~331 / 561~102, C = 3.05⁺⁰ mm at 471



PRODUCT IDENTIFICATION

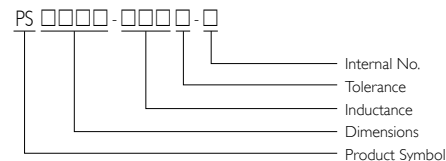

■ Internal No.: N = Lead-Free

Unit: mm

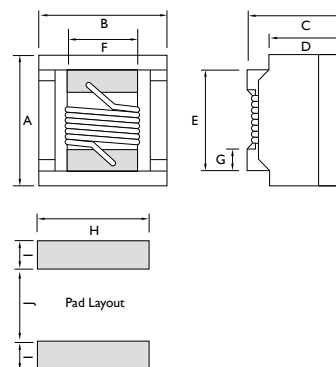



ELECTRICAL CHARACTERISTICS

PART NO.	INDUCTANCE (μ H)	TEST FREQUENCY (MHz)	TOLERANCE (\pm %)	Q TYPICAL	TEST FREQUENCY (MHz)	SRF (MHz) Typ.	DC RESISTANCE (Ω) Max.	IDC (A)
PSI008-1R0□-N	1.0	0.1	10 / 20	26	1	344	0.05	3.00
PSI008-1R5□-N	1.5	0.1	10 / 20	26	1	260	0.08	2.80
PSI008-1R8□-N	1.8	0.1	10 / 20	28	1	225	0.09	2.10
PSI008-2R7□-N	2.7	0.1	10 / 20	30	1	185	0.14	1.50
PSI008-3R9□-N	3.9	0.1	10 / 20	30	1	172	0.29	1.20
PSI008-4R7□-N	4.7	0.1	10 / 20	30	1	157	0.35	1.10
PSI008-5R6□-N	5.6	0.1	10 / 20	30	1	150	0.39	1.10
PSI008-6R8□-N	6.8	0.1	10 / 20	30	1	110	0.58	0.90
PSI008-100□-N	10	0.1	10 / 20	30	1	95	0.75	0.82
PSI008-150□-N	15	0.1	10 / 20	30	1	75	1.15	0.70
PSI008-220□-N	22	0.1	10 / 20	33	1	30	1.40	0.65
PSI008-330□-N	33	0.1	10 / 20	33	1	21	1.61	0.52
PSI008-390□-N	39	0.1	10 / 20	33	1	18	1.85	0.46
PSI008-470□-N	47	0.1	10 / 20	33	1	15	2.20	0.43
PSI008-680□-N	68	0.1	10 / 20	33	1	12	3.80	0.33
PSI008-820□-N	82	0.1	10 / 20	33	1	10	4.30	0.32
PSI008-101□-N	100	0.1	10 / 20	33	1	8.0	4.80	0.31
PSI008-121□-N	120	0.1	10 / 20	33	1	8.0	5.00	0.25
PSI008-151□-N	150	0.1	10 / 20	33	1	5.8	6.50	0.24
PSI008-221□-N	220	0.1	10 / 20	33	1	5.5	12.0	0.22
PSI008-331□-N	330	0.1	10 / 20	33	1	3.8	17.0	0.20
PSI008-471□-N	470	0.1	10 / 20	33	1	3.1	19.0	0.16
PSI008-561□-N	560	0.1	10 / 20	33	1	2.8	18.4	0.13
PSI008-681□-N	680	0.1	10 / 20	33	1	2.5	24.0	0.12
PSI008-821□-N	820	0.1	10 / 20	23	1	2.0	26.0	0.10
PSI008-102□-N	1,000	0.1	10 / 20	20	1	1.5	29.2	0.10

Note:

When ordering, please specify tolerance and packaging codes.

Tolerance: K = \pm 10%, M = \pm 20%

Packaging: Clear tape and reel (standard)

Test Instruments: L- Agilent/HP4285A (0.1 Vrms)

Q- Agilent/HP4291A+Agilent/HPI6197A

SRF- Agilent/HP4291A

RDC- CH502BC/HP4338B

IDC- For Inductance drop 10% from its value without current

Operating Temperature Range: -25 °C to +85 °C

TAPE DIMENSIONS

Unit: mm

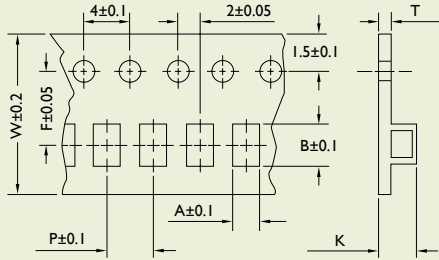

TYPE	A	B	T	W	P	F	K
PSI008	3.85	3.85	0.25	12	8	5.5	2.85

TAPE MATERIAL

PACKAGING QUANTITY

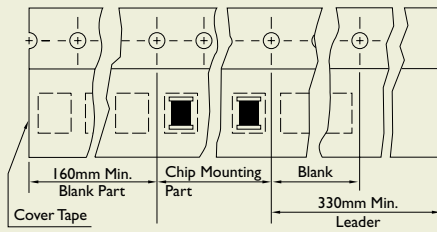

TYPE	QUANTITY/REEL
PSI008	750

REEL DIMENSIONS

Unit: mm

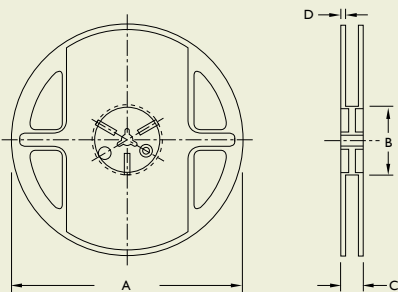

TYPE	A	B	C	D
PSI008	178	60	16	1.4

SMD Wire Wound Chip Inductors

CS Series



PRODUCT IDENTIFICATION

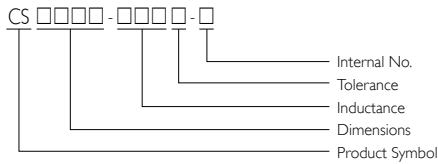

APPLICATIONS

RF products for Cellular Phone, GPS Receiver, Base Station, Repeater, Wireless LAN/Mouse/Keyboard/ Earphone, Remote Control, Security System and other RF modules.

OUTLINE

Based on our technical expertise and skill in accurately winding, these chip inductors are designed as filtering, impedance matching, resonance and choke circuits for RF designers.

The standard series as well as custom design to meet your needs of telecom & wireless products.

FEATURES

Ceramic body and wire wound construction provide highest SRFs.

These ultra-compact inductors provided exceptional Q values, even at high frequencies.

Their ceramic construction delivers the highest possible SRFs as well as excellent Q values.

The non-magnetic coil form also assures the utmost in thermal stability, predictability and batch consistency.

CS series is standard parts for RF designers.

SHAPES AND DIMENSIONS

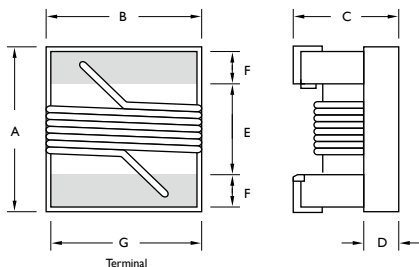

TYPE	UNIT	A	B	C	D	E	F	G
		Max.	Max.	Max.				
CS0402	inch	0.047	0.028	0.026	0.010	0.020	0.009	0.022
	mm	1.19	0.70	0.66	0.25	0.51	0.23	0.56
CS0603	inch	0.070	0.044	0.040	0.015	0.030	0.013	0.034
	mm	1.6 +0.2/-0.1	1.02 ± 0.1	0.82 +0.2/-0.1	0.38	0.76	0.33	0.86
CS0805	inch	0.093	0.068	0.060	0.020	0.050	0.020	0.040
	mm	2.35	1.73	1.52	0.51	1.27	0.51	1.02
CS1008	inch	0.115	0.110	0.083	0.020	0.080	0.020	0.060
	mm	2.92	2.79	2.10	0.51	2.03	0.51	1.52

ELECTRICAL CHARACTERISTICS CS0402

PART NO.	INDUCTANCE (μ H)	TOLERANCE (\pm %)	Q Min.	SRF (MHz) Min.	DC RESISTANCE (Ω) Max.	I _{rms} (mA) Max.	900MHz		1.7GHz	
							L Typ.	Q Typ.	L Typ.	Q Typ.
CS0402-1N0□-S	1.0	5 / 10	16	12.7	0.045	1,360	1.02	77	1.02	69
CS0402-1N9□-S	1.9	5 / 10	16	11.3	0.070	1,040	1.72	68	1.74	82
CS0402-2N0□-S	2.0	5 / 10	16	11.1	0.070	1,040	1.93	54	1.93	75
CS0402-2N2□-S	2.2	5 / 10	19	10.8	0.070	960	2.19	59	2.23	100
CS0402-2N4□-S	2.4	5 / 10	15	10.5	0.068	790	2.24	51	2.27	68
CS0402-2N7□-S	2.7	5 / 10	16	10.4	0.120	640	2.58	42	2.60	61
CS0402-3N3□-S	3.3	5 / 10	19	7.00	0.066	840	3.10	65	3.12	87
CS0402-3N6□-S	3.6	5 / 10	19	6.80	0.066	840	3.56	45	3.62	71
CS0402-3N9□-S	3.9	5 / 10	19	6.00	0.066	840	3.89	50	4.00	75
CS0402-4N3□-S	4.3	5 / 10	18	6.00	0.091	700	4.19	47	4.30	71
CS0402-4N7□-S	4.7	5 / 10	15	4.77	0.130	640	4.55	48	4.68	68
CS0402-5N1□-S	5.1	5 / 10	20	4.80	0.083	800	5.15	56	5.25	82
CS0402-5N6□-S	5.6	5 / 10	20	4.80	0.083	760	5.16	54	5.28	81
CS0402-6N2□-S	6.2	5 / 10	20	4.80	0.083	760	6.16	52	6.37	76
CS0402-6N8□-S	6.8	5 / 10	20	4.80	0.083	680	6.56	63	6.93	78
CS0402-7N5□-S	7.5	5 / 10	22	4.80	0.10	680	7.91	60	8.22	88
CS0402-8N2□-S	8.2	5 / 10	22	4.40	0.10	680	8.50	57	8.85	84
CS0402-8N7□-S	8.7	5 / 10	18	4.10	0.20	480	8.78	54	9.21	73
CS0402-9N0□-S	9.0	5 / 10	22	4.16	0.10	680	9.07	62	9.53	78
CS0402-9N5□-S	9.5	5 / 10	18	4.00	0.20	480	9.42	54	9.98	69
CS0402-10N□-S	10	5 / 10	21	3.90	0.20	480	9.80	50	10.10	67
CS0402-11N□-S	11	5 / 10	24	3.68	0.12	640	10.70	52	11.20	78
CS0402-12N□-S	12	5 / 10	24	3.60	0.12	640	11.90	53	12.70	71
CS0402-13N□-S	13	5 / 10	24	3.45	0.21	440	13.40	51	14.63	57
CS0402-15N□-S	15	5 / 10	24	3.28	0.17	560	14.60	55	15.50	77
CS0402-16N□-S	16	5 / 10	24	3.10	0.22	560	16.60	46	18.86	47
CS0402-18N□-S	18	5 / 10	25	3.10	0.23	420	18.30	57	20.28	62
CS0402-19N□-S	19	5 / 10	24	3.04	0.20	480	19.10	50	21.10	67
CS0402-20N□-S	20	5 / 10	25	3.00	0.25	420	20.70	52	23.66	53
CS0402-22N□-S	22	5 / 10	25	2.80	0.30	400	23.20	53	26.75	53
CS0402-23N□-S	23	5 / 10	22	2.72	0.30	400	23.80	49	26.90	64
CS0402-24N□-S	24	5 / 10	25	2.70	0.30	400	25.10	51	29.50	50
CS0402-27N□-S	27	5 / 10	24	2.48	0.30	400	28.70	49	33.50	63
CS0402-30N□-S	30	5 / 10	25	2.35	0.35	400	31.10	46	38.50	39
CS0402-33N□-S	33	5 / 10	24	2.35	0.40	400	34.90	31	41.74	32
CS0402-36N□-S	36	5 / 10	24	2.32	0.44	320	39.50	44	48.40	53
CS0402-39N□-S	39	5 / 10	25	2.10	0.55	200	41.70	47	50.23	45
CS0402-40N□-S	40	5 / 10	24	2.24	0.44	320	39.00	44	47.40	33
CS0402-43N□-S	43	5 / 10	25	2.03	0.81	100	45.80	46	61.55	34
CS0402-47N□-S	47	5 / 10	20	2.10	0.83	150	50.00	38	-	-
CS0402-51N□-S	51	5 / 10	25	1.75	0.82	100	56.60	40	-	-
CS0402-56N□-S	56	5 / 10	22	1.76	0.97	100	62.80	42	-	-
CS0402-68N□-S	68	5 / 10	22	1.62	1.12	100	78.20	36	-	-
CS0402-82N□-S	82	5 / 10	20	1.26	1.55	50	-	-	-	-
CS0402-R10□-S	100	5 / 10	20	1.16	2.00	30	-	-	-	-

When ordering, please specify tolerance and packaging codes.

Test Instruments: L/Q- Agilent/HP4291A+Agilent/HP16197A at 250MHz; SRF- Agilent/HP8753D+Agilent/HP8722ES

Tolerance: J = \pm 5%, K = \pm 10%

Packaging: Clear tape and reel (standard)



ELECTRICAL CHARACTERISTICS CS0603

PART NO.	INDUCTANCE (μ H)	TOLERANCE (\pm %)	TEST FREQUENCY (MHz)	Q Min.	SRF (MHz) Min.	DC RESISTANCE (Ω) Max.	I _{rms} (mA) Max.	900MHz		1.7GHz		COLOR CODING
								L Typ.	Q Typ.	L Typ.	Q Typ.	
CS0603-1N6□-S	1.6	5 / 10	250	24	12,500	0.030	700	1.67	49	1.65	63	Red
CS0603-1N8□-S	1.8	5 / 10	250	16	12,500	0.045	700	1.63	35	1.66	50	Black
CS0603-3N6□-S	3.6	5 / 10	250	22	5,900	0.063	700	3.72	53	3.71	65	Red
CS0603-3N9□-S	3.9	5 / 10	250	22	6,900	0.080	700	3.95	49	3.96	67	Brown
CS0603-4N3□-S	4.3	5 / 10	250	22	5,900	0.063	700	4.32	50	4.33	70	Orange
CS0603-4N7□-S	4.7	5 / 10	250	20	5,800	0.116	700	4.72	47	4.75	57	Violet
CS0603-5N1□-S	5.1	5 / 10	250	20	5,700	0.140	700	4.93	47	4.95	56	Green
CS0603-5N6□-S	5.6	5 / 10	250	20	5,800	0.170	700	5.53	56	5.86	77	Yellow
CS0603-6N3□-S	6.3	5 / 10	250	20	5,700	0.140	700	5.50	47	6.10	60	White
CS0603-6N8□-S	6.8	5 / 10	250	27	5,800	0.110	700	6.75	60	7.10	81	Red
CS0603-7N5□-S	7.5	5 / 10	250	28	4,800	0.106	700	7.70	60	7.82	65	Brown
CS0603-8N2□-S	8.2	5 / 10	250	28	4,700	0.109	700	8.30	60	8.50	60	White
CS0603-8N7□-S	8.7	5 / 10	250	28	4,600	0.109	700	8.86	62	9.32	58	Yellow
CS0603-9N5□-S	9.5	5 / 10	250	28	5,400	0.135	700	9.70	59	9.92	61	Blue
CS0603-10N□-S	10	2 / 5 / 10	250	31	4,800	0.130	700	10.0	66	10.6	83	Orange
CS0603-11N□-S	11	2 / 5 / 10	250	33	4,000	0.086	700	11.0	53	11.5	56	Gray
CS0603-12N□-S	12	2 / 5 / 10	250	35	4,000	0.130	700	12.3	72	13.5	83	Yellow
CS0603-15N□-S	15	2 / 5 / 10	250	35	4,000	0.170	700	15.4	64	16.8	89	Green
CS0603-16N□-S	16	2 / 5 / 10	250	34	3,300	0.104	700	16.2	55	17.3	52	White
CS0603-18N□-S	18	2 / 5 / 10	250	35	3,100	0.170	700	18.7	70	21.4	69	Blue
CS0603-22N□-S	22	2 / 5 / 10	250	38	3,000	0.190	700	22.8	73	26.1	71	Violet
CS0603-24N□-S	24	2 / 5 / 10	250	37	2,650	0.135	700	24.5	45	28.7	39	Black
CS0603-27N□-S	27	2 / 5 / 10	250	40	2,800	0.220	600	29.2	74	34.6	65	Gray
CS0603-30N□-S	30	2 / 5 / 10	250	37	2,250	0.144	600	31.4	47	39.9	28	Brown
CS0603-33N□-S	33	2 / 5 / 10	250	40	2,300	0.220	600	36.0	67	49.5	42	White
CS0603-36N□-S	36	2 / 5 / 10	250	38	2,080	0.250	600	39.4	47	52.7	24	Red
CS0603-39N□-S	39	2 / 5 / 10	250	40	2,200	0.250	600	42.7	60	60.2	40	Black
CS0603-43N□-S	43	2 / 5 / 10	250	39	2,000	0.280	600	47.0	44	64.9	21	Orange
CS0603-47N□-S	47	2 / 5 / 10	200	38	2,000	0.280	600	52.2	62	77.2	35	Brown
CS0603-56N□-S	56	2 / 5 / 10	200	38	1,900	0.310	600	62.5	56	97.0	26	Red
CS0603-68N□-S	68	2 / 5 / 10	200	37	1,700	0.340	600	80.5	54	168	21	Orange
CS0603-72N□-S	72	2 / 5 / 10	150	34	1,700	0.490	400	82.0	53	135	20	Yellow
CS0603-82N□-S	82	2 / 5 / 10	150	34	1,700	0.540	400	96.2	54	177	21	Green
CS0603-R10□-S	100	2 / 5 / 10	150	34	1,400	0.580	400	124.0	49	-	-	Blue
CS0603-R11□-S	110	2 / 5 / 10	150	32	1,350	0.610	300	138.0	43	-	-	Violet
CS0603-R12□-S	120	2 / 5 / 10	150	32	1,300	0.750	300	166.0	39	-	-	Gray
CS0603-R15□-S	150	2 / 5 / 10	150	28	990	0.920	280	250.0	25	-	-	White
CS0603-R18□-S	180	2 / 5 / 10	100	25	990	1.250	240	305.0	22	-	-	Black
CS0603-R22□-S	220	2 / 5 / 10	100	25	900	2.100	200	-	-	-	-	Brown
CS0603-R27□-S	270	2 / 5 / 10	100	24	900	2.800	170	-	-	-	-	Red
CS0603-R33□-S	330	2 / 5 / 10	100	25	900	3.890	100	-	-	-	-	Orange
CS0603-R39□-S	390	2 / 5 / 10	100	25	900	4.350	100	-	-	-	-	Yellow

When ordering, please specify tolerance and packaging codes.

Test Instruments: L/Q- Agilent/HP4291A+Agilent/HPI 6197A; SRF- HP8753D/HP4291A; RDC- CH502BC/HP4338B; I_{rms}- For a 15 °C rise above 25 °C ambient.

Operating Temperature Range: -40 °C to +125 °C

Tolerance: G = \pm 2%, J = \pm 5%, K = \pm 10%

Packaging: Clear tape and reel (standard)

ELECTRICAL CHARACTERISTICS CS0805

PART NO.	INDUCTANCE (μH)	TOLERANCE (±%)	TEST FREQUENCY (MHz)	Q Min.	TEST FREQUENCY (MHz)	SRF (MHz) Min.	DC RESISTANCE (Ω) Max.	I_{rms} (mA) Max.	COLOR CODING
CS0805-2N8□-S	2.8	5 / 10	250	80	1,500	7,900	0.06	800	Gray
CS0805-3N0□-S	3.0	5 / 10	250	65	1,500	7,900	0.06	800	White
CS0805-3N3□-S	3.3	5 / 10	250	50	1,500	7,900	0.08	600	Black
CS0805-5N6□-S	5.6	5 / 10	250	65	1,000	5,500	0.08	600	Orange
CS0805-6N8□-S	6.8	5 / 10	250	50	1,000	5,500	0.11	600	Brown
CS0805-7N5□-S	7.5	5 / 10	250	50	1,000	4,500	0.14	600	Green
CS0805-8N2□-S	8.2	5 / 10	250	50	1,000	4,700	0.12	600	Red
CS0805-10N□-S	10	2 / 5 / 10	250	60	500	4,200	0.10	600	Blue
CS0805-12N□-S	12	2 / 5 / 10	250	50	500	4,000	0.15	600	Orange
CS0805-15N□-S	15	2 / 5 / 10	250	50	500	3,400	0.17	600	Yellow
CS0805-18N□-S	18	2 / 5 / 10	250	50	500	3,300	0.20	600	Green
CS0805-22N□-S	22	2 / 5 / 10	250	55	500	2,600	0.22	500	Blue
CS0805-24N□-S	24	2 / 5 / 10	250	50	500	2,000	0.22	500	Gray
CS0805-27N□-S	27	2 / 5 / 10	250	55	500	2,500	0.25	500	Violet
CS0805-33N□-S	33	2 / 5 / 10	250	60	500	2,050	0.27	500	Gray
CS0805-36N□-S	36	2 / 5 / 10	250	55	500	1,700	0.27	500	Orange
CS0805-39N□-S	39	2 / 5 / 10	250	60	500	2,000	0.29	500	White
CS0805-43N□-S	43	2 / 5 / 10	200	60	500	1,650	0.34	500	Yellow
CS0805-47N□-S	47	2 / 5 / 10	200	60	500	1,650	0.31	500	Black
CS0805-56N□-S	56	2 / 5 / 10	200	60	500	1,550	0.34	500	Brown
CS0805-68N□-S	68	2 / 5 / 10	200	60	500	1,450	0.38	500	Red
CS0805-82N□-S	82	2 / 5 / 10	150	65	500	1,300	0.42	400	Orange
CS0805-91N□-S	91	2 / 5 / 10	150	65	500	1,200	0.48	400	Black
CS0805-R10□-S	100	2 / 5 / 10	150	65	500	1,200	0.46	400	Yellow
CS0805-R11□-S	110	2 / 5 / 10	150	50	250	1,000	0.48	400	Brown
CS0805-R12□-S	120	2 / 5 / 10	150	50	250	1,100	0.51	400	Green
CS0805-R15□-S	150	2 / 5 / 10	100	50	250	920	0.56	400	Blue
CS0805-R18□-S	180	2 / 5 / 10	100	50	250	870	0.64	400	Violet
CS0805-R20□-S	200	2 / 5 / 10	100	50	250	860	0.68	400	Red
CS0805-R22□-S	220	2 / 5 / 10	100	50	250	850	0.70	400	Gray
CS0805-R24□-S	240	2 / 5 / 10	100	44	250	690	1.00	350	Red
CS0805-R25□-S	250	2 / 5 / 10	100	45	250	660	1.20	350	Yellow
CS0805-R27□-S	270	2 / 5 / 10	100	48	250	650	1.00	350	White
CS0805-R33□-S	330	2 / 5 / 10	100	48	250	600	1.40	310	Black
CS0805-R39□-S	390	2 / 5 / 10	100	48	250	560	1.50	290	Brown
CS0805-R47□-S	470	2 / 5 / 10	50	33	100	375	1.76	250	Violet
CS0805-R56□-S	560	2 / 5 / 10	25	23	50	340	1.90	230	Orange
CS0805-R62□-S	620	2 / 5 / 10	25	23	50	220	2.20	210	Yellow
CS0805-R68□-S	680	2 / 5 / 10	25	23	50	188	2.20	190	Green
CS0805-R82□-S	820	2 / 5 / 10	25	23	50	215	2.35	180	Blue
CS0805-1R0□-S	1,000	2 / 5 / 10	25	20	50	100	2.50	170	Gray

When ordering, please specify tolerance and packaging codes.

Test Instruments: L/Q- Agilent/HP4291A+Agilent/HP16197A; SRF- HP8753D/HP4291A; RDC- CH502BC/HP4338B; I_{rms}- For a 15 °C rise above 25 °C ambient.

Operating Temperature Range: -40 °C to +125 °C

Tolerance: G = ± 2%, J = ± 5%, K = ± 10%

Packaging: Clear tape and reel (standard)



ELECTRICAL CHARACTERISTICS CS1008

PART NO.	INDUCTANCE (μH)	TOLERANCE ($\pm\%$)	TEST FREQUENCY (MHz)	Q Min.	TEST FREQUENCY (MHz)	SRF (MHz) Min.	DC RESISTANCE (Ω) Max.	I _{rms} (mA) Max.	COLOR CODING		
									1 st	2 nd	3 rd
CSI008-10N□-S	10	2 / 5 / 10	50	50	500	4,100	0.08	1,000	Brown	Black	Black
CSI008-12N□-S	12	2 / 5 / 10	50	50	500	3,300	0.09	1,000	Brown	Red	Black
CSI008-15N□-S	15	2 / 5 / 10	50	50	500	2,500	0.10	1,000	Brown	Green	Black
CSI008-18N□-S	18	2 / 5 / 10	50	50	350	2,500	0.11	1,000	Brown	Gray	Black
CSI008-22N□-S	22	2 / 5 / 10	50	55	350	2,400	0.12	1,000	Red	Red	Black
CSI008-27N□-S	27	2 / 5 / 10	50	55	350	1,600	0.13	1,000	Red	Violet	Black
CSI008-33N□-S	33	2 / 5 / 10	50	60	350	1,600	0.14	1,000	Orange	Orange	Black
CSI008-39N□-S	39	2 / 5 / 10	50	60	350	1,500	0.15	1,000	Orange	White	Black
CSI008-47N□-S	47	2 / 5 / 10	50	65	350	1,500	0.16	1,000	Yellow	Violet	Black
CSI008-56N□-S	56	2 / 5 / 10	50	65	350	1,300	0.18	1,000	Green	Blue	Black
CSI008-68N□-S	68	2 / 5 / 10	50	65	350	1,300	0.20	1,000	Blue	Gray	Black
CSI008-82N□-S	82	2 / 5 / 10	50	60	350	1,000	0.22	1,000	Gray	Red	Black
CSI008-R10□-S	100	2 / 5 / 10	25	60	350	1,000	0.56	650	Brown	Black	Brown
CSI008-R12□-S	120	2 / 5 / 10	25	60	350	950	0.63	650	Brown	Red	Brown
CSI008-R15□-S	150	2 / 5 / 10	25	45	100	850	0.70	580	Brown	Green	Brown
CSI008-R18□-S	180	2 / 5 / 10	25	45	100	750	0.77	620	Brown	Gray	Brown
CSI008-R22□-S	220	2 / 5 / 10	25	45	100	700	0.84	500	Red	Red	Brown
CSI008-R27□-S	270	2 / 5 / 10	25	45	100	600	0.91	500	Red	Violet	Brown
CSI008-R33□-S	330	2 / 5 / 10	25	45	100	570	1.05	450	Orange	Orange	Brown
CSI008-R39□-S	390	2 / 5 / 10	25	45	100	500	1.12	470	Orange	White	Brown
CSI008-R47□-S	470	2 / 5 / 10	25	45	100	450	1.19	470	Yellow	Violet	Brown
CSI008-R56□-S	560	2 / 5 / 10	25	45	100	415	1.33	400	Green	Blue	Brown
CSI008-R62□-S	620	2 / 5 / 10	25	45	100	375	1.40	300	Blue	Red	Brown
CSI008-R68□-S	680	2 / 5 / 10	25	45	100	375	1.47	400	Blue	Gray	Brown
CSI008-R75□-S	750	2 / 5 / 10	25	45	100	360	1.54	360	Violet	Green	Brown
CSI008-R82□-S	820	2 / 5 / 10	25	45	100	350	1.61	400	Gray	Red	Brown
CSI008-R91□-S	910	2 / 5 / 10	25	35	50	320	1.68	380	White	Brown	Brown
CSI008-1R0□-S	1,000	2 / 5 / 10	25	35	50	290	1.75	370	Brown	Black	Red
CSI008-1R2□-S	1,200	2 / 5 / 10	7.90	35	50	250	2.00	310	Brown	Red	Red
CSI008-1R5□-S	1,500	2 / 5 / 10	7.90	28	50	200	2.30	330	Brown	Green	Red
CSI008-1R8□-S	1,800	2 / 5 / 10	7.90	28	50	160	2.60	300	Brown	Gray	Red
CSI008-2R2□-S	2,200	2 / 5 / 10	7.90	28	50	160	2.80	280	Red	Red	Red
CSI008-2R7□-S	2,700	2 / 5 / 10	7.90	22	25	140	3.20	290	Red	Violet	Red
CSI008-3R3□-S	3,300	2 / 5 / 10	7.90	22	25	110	3.40	290	Orange	Orange	Red
CSI008-3R9□-S	3,900	2 / 5 / 10	7.90	20	25	100	3.60	260	Orange	White	Red
CSI008-4R7□-S	4,700	2 / 5 / 10	7.90	20	25	90	4.00	260	Yellow	Violet	Red
CSI008-5R6□-S	5,600	2 / 5 / 10	7.90	18	7.9	45	4.00	240	Green	Blue	Red
CSI008-6R8□-S	6,800	2 / 5 / 10	7.90	18	7.9	40	4.90	200	Blue	Gray	Red
CSI008-8R2□-S	8,200	2 / 5 / 10	7.90	18	7.9	25	6.00	170	Gray	Red	Red
CSI008-100□-S	10,000	2 / 5 / 10	2.52	18	7.9	25	8.00	150	Brown	Black	Orange

When ordering, please specify tolerance and packaging codes.

Test Instruments: L/Q- Agilent/HP4291A+Agilent/HPI6197A; SRF- HP8753D/HP4291A;
RDC- CH502BC/HP4338B; I_{rms}- For a 15 °C rise above 25 °C ambient.

Operating Temperature Range: -40 °C to +125 °C

Tolerance: G = $\pm 2\%$, J = $\pm 5\%$, K = $\pm 10\%$

Packaging: Clear tape and reel (standard)

Color Coding

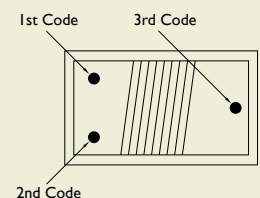

TAPE DIMENSIONS

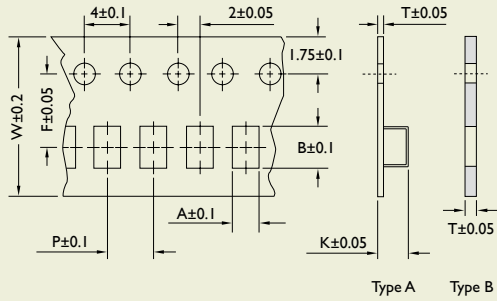

TAPE MATERIAL

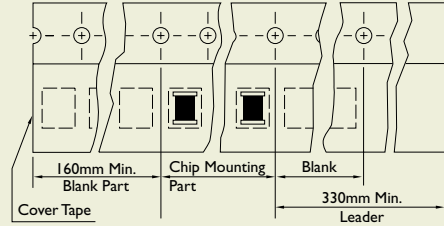

REEL DIMENSIONS

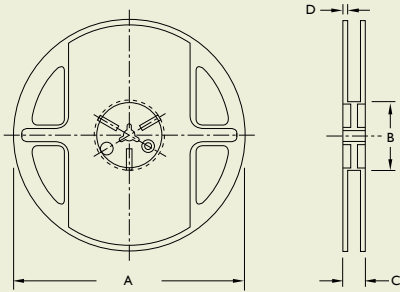

RECOMMENDED PATTERN

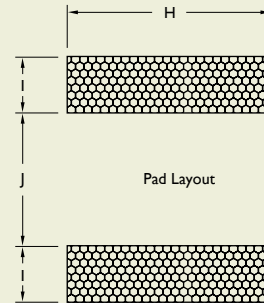

Dimensions: mm

TYPE	TAPE DIMENSIONS								TAPE TYPE	RECOMMENDED PATTERN			REEL DIMENSIONS				QUANTITY/ REEL
	A	B	T	W	P	F	K	UNIT		H	I	J	A	B	C	D	
CS0402	0.74	1.23	0.68	8	2	3.50	-	B	inch	0.026	0.014	0.018	178	60	12	1.5	4,000
									mm	0.66	0.36	0.46					
CS0603	1.23	1.90	0.97	8	4	3.50	-	B	inch	0.040	0.025	0.025	178	60	12	1.5	4,000
									mm	1.02	0.64	0.64					
CS0805	1.85	2.45	0.23	8	4	3.50	1.45	A	inch	0.070	0.040	0.030	178	60	12	1.5	2,000
									mm	1.78	1.02	0.76					
CS1008	2.80	2.95	0.23	8	4	3.50	2.20	A	inch	0.100	0.040	0.050	178	60	16	1.5	2,000
									mm	2.54	1.02	1.27					

SMD Wire Wound Chip Inductors

CT Series



PRODUCT IDENTIFICATION

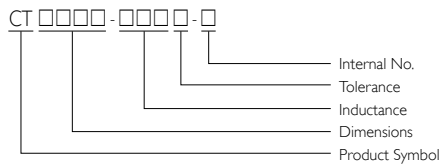

APPLICATIONS

RF products for Cellular Phone, GPS Receiver, Base Station, Repeater, Wireless LAN/Mouse/Keyboard/ Earphone, Remote Control, Security System and other RF modules.

OUTLINE

Based on our technical expertise and skill in accurately winding, these chip inductors are designed as filtering, impedance matching, resonance and choke circuits for RF designers.

The standard series as well as custom design to meet your needs of telecom & wireless products.

FEATURES

Meet Sony SS-00259's criteria for lead-free product.

Ceramic body and wire wound construction provide highest SRFs.

These ultra-compact inductors provide exceptional Q values, even at high frequencies.

Their ceramic construction delivers the highest possible SRFs as well as excellent Q values.

The non-magnetic coil form also assures the utmost in thermal stability, predictability and batch consistency.

At just 1.02 mm high, CT0805 is the lowest profile SMD inductor.

SHAPES AND DIMENSIONS

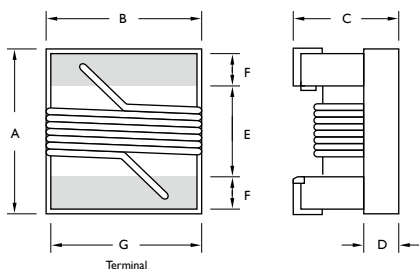

TYPE	UNIT	A	B	C	D	E	F	G
		Max.	Max.	Max.				
CT0805	inch	0.093	0.068	0.039	0.020	0.050	0.020	0.040
	mm	2.35	1.73	1.10	0.51	1.27	0.51	1.02

ELECTRICAL CHARACTERISTICS

PART NO.	INDUCTANCE (nH)	TOLERANCE (±%)	TEST FREQUENCY (MHz)	Q Min.	TEST FREQUENCY (MHz)	SRF (MHz) Min.	DC RESISTANCE (Ω) Max.	I _{rms} (mA) Max.	COLOR CODING
CT0805-1N8□-S	1.8	10	250	55	1,500	9,400	0.03	800	Black
CT0805-3N9□-S	3.9	10	250	50	1,000	6,100	0.06	800	Brown
CT0805-4N7□-S	4.7	5 / 10	250	50	1,000	5,500	0.06	800	Red
CT0805-6N8□-S	6.8	5 / 10	250	50	1,000	5,500	0.08	800	Orange
CT0805-8N2□-S	8.2	5 / 10	250	50	1,000	4,800	0.08	800	Yellow
CT0805-10N□-S	10	2 / 5 / 10	250	55	750	3,300	0.08	800	Green
CT0805-12N□-S	12	2 / 5 / 10	250	55	750	3,800	0.10	800	Blue
CT0805-15N□-S	15	2 / 5 / 10	250	50	500	2,950	0.10	800	Violet
CT0805-18N□-S	18	2 / 5 / 10	250	50	500	3,100	0.13	800	Gray
CT0805-22N□-S	22	2 / 5 / 10	250	50	500	2,900	0.15	800	White
CT0805-27N□-S	27	2 / 5 / 10	250	50	500	2,450	0.23	600	Black
CT0805-33N□-S	33	2 / 5 / 10	250	55	500	2,350	0.28	600	Brown
CT0805-39N□-S	39	2 / 5 / 10	250	55	500	2,200	0.33	600	Red
CT0805-47N□-S	47	2 / 5 / 10	200	50	500	2,000	0.39	600	Orange
CT0805-56N□-S	56	2 / 5 / 10	200	50	500	1,850	0.39	500	Yellow
CT0805-68N□-S	68	2 / 5 / 10	200	50	500	1,500	0.40	500	Green
CT0805-82N□-S	82	2 / 5 / 10	150	50	500	1,500	0.44	500	Blue
CT0805-R10□-S	100	2 / 5 / 10	150	50	500	1,200	0.64	400	Violet
CT0805-R12□-S	120	2 / 5 / 10	150	40	250	1,150	0.68	300	Gray
CT0805-R15□-S	150	2 / 5 / 10	150	40	250	1,050	0.80	300	White
CT0805-R18□-S	180	2 / 5 / 10	150	40	250	950	0.90	300	Black
CT0805-R22□-S	220	2 / 5 / 10	150	40	250	900	0.98	300	Brown
CT0805-R27□-S	270	2 / 5 / 10	150	40	250	850	1.30	300	Red
CT0805-R33□-S	330	2 / 5 / 10	100	40	250	800	1.45	300	Orange
CT0805-R39□-S	390	2 / 5 / 10	100	35	250	700	1.60	300	Yellow
CT0805-R47□-S	470	2 / 5 / 10	50	25	100	600	1.80	300	Green
CT0805-R56□-S	560	2 / 5 / 10	25	18	50	550	1.90	300	Blue
CT0805-R62□-S	620	2 / 5 / 10	25	18	50	450	2.00	300	Violet
CT0805-R68□-S	680	2 / 5 / 10	25	18	50	420	2.10	300	Gray
CT0805-R75□-S	750	2 / 5 / 10	25	18	50	400	2.20	300	White
CT0805-R82□-S	820	2 / 5 / 10	25	18	50	400	2.50	300	Black
CT0805-1R0□-S	1,000	5 / 10	25	17	50	330	3.10	300	Brown

Note:

When ordering, please specify tolerance and packaging codes.

Tolerance: G = ± 2%, J = ± 5%, K = ± 10%

Packaging: Clear tape and reel (standard)

Test Instruments: L/Q- Agilent/HP4291A+Agilent/HP16197A

SRF- Agilent/HP8753D+Agilent/HP4291A

RDC- CH502BC/HP4338B

I_{rms}- For a 15 °C rise above 25 °C ambient.

Operating Temperature Range: -40 °C to +125 °C



TAPE DIMENSIONS

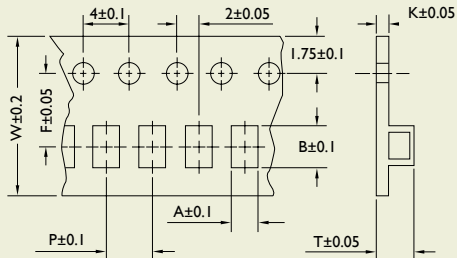

TAPE MATERIAL

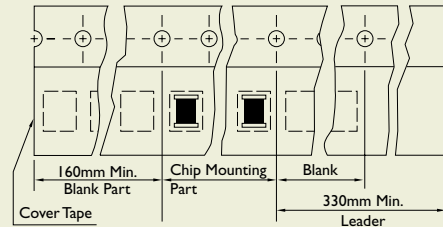

REEL DIMENSIONS

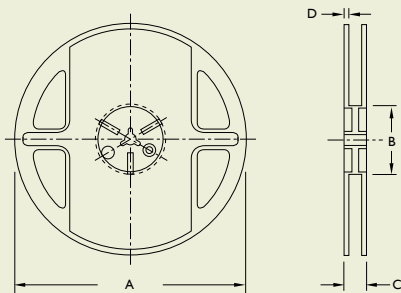

RECOMMENDED PATTERN

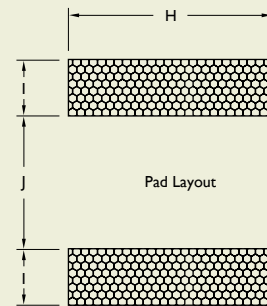

Dimensions: mm

TYPE	TAPE DIMENSIONS							RECOMMENDED PATTERN			REEL DIMENSIONS				QUANTITY/ REEL	
	A	B	T	W	P	F	K	UNIT	H	I	J	A	B	C		D
CT0805	1.85	2.45	1.00	8	4	3.50	0.23	inch	0.070	0.040	0.030	178	60	12	1.5	2,000
								mm	1.78	1.02	0.76					

HC Series

SMD Wire Wound Chip Inductors

APPLICATIONS

RF products for Cellular Phone, GPS Receiver; Base Station, Repeater; Wireless LAN/Mouse/Keyboard/ Earphone, Remote Control, Security System and other RF modules.

OUTLINE

Based on our technical expertise and skill in accurately winding, these chip inductors are designed as filtering, impedance matching, resonance and choke circuits for RF designers.

The standard series as well as custom design to meet your needs of telecom & wireless products.

FEATURES

Meet Sony SS-00259's criteria for lead-free product.

Ceramic body and wire wound construction provide highest SRFs.

These ultra-compact inductors provide exceptional Q values, even at high frequencies.

Their ceramic construction delivers the highest possible SRFs as well as excellent Q values.

The non-magnetic coil form also assures the utmost in thermal stability, predictability and batch consistency.

The high current rating and low loss to fit the RF applications.

SHAPES AND DIMENSIONS

TYPE	UNIT	A	B	C	D	E	F	G
		Max.	Max.	Max.				
HC0603	inch	0.071	0.049	0.040	0.015	0.030	0.013	0.034
	mm	1.80	1.25	1.02	0.38	0.76	0.33	0.86



PRODUCT IDENTIFICATION

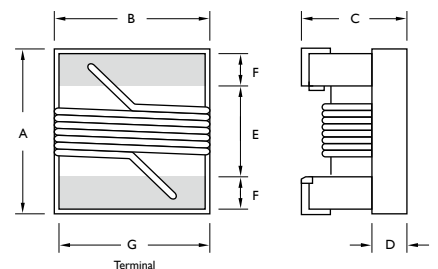
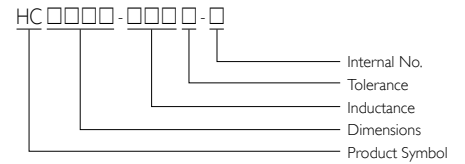



ELECTRICAL CHARACTERISTICS

PART NO.	INDUCTANCE (nH)	TOLERANCE (±%)	TEST FREQUENCY (MHz)	Q Min.	TEST FREQUENCY (MHz)	SRF (MHz) Min.	DC RESISTANCE (Ω) Max.	I _{rms} (mA) Max.	COLOR CODING
HC0603-1N6□-S	1.6	5 / 10	250	24	250	12,500	0.030	2,400	Black
HC0603-3N6□-S	3.6	5 / 10	250	24	250	5,900	0.048	2,300	Brown
HC0603-3N9□-S	3.9	5 / 10	250	25	250	5,900	0.054	2,200	Red
HC0603-6N8□-S	6.8	5 / 10	250	35	250	5,800	0.054	2,100	Orange
HC0603-7N5□-S	7.5	5 / 10	250	35	250	3,700	0.059	2,100	Yellow
HC0603-10N□-S	10	2 / 5 / 10	250	38	250	3,700	0.071	2,000	Green
HC0603-12N□-S	12	2 / 5 / 10	250	38	250	3,000	0.075	2,000	Blue
HC0603-15N□-S	15	2 / 5 / 10	250	38	250	2,800	0.080	1,900	Violet
HC0603-18N□-S	18	2 / 5 / 10	250	40	250	2,800	0.099	1,900	Gray
HC0603-22N□-S	22	2 / 5 / 10	250	42	250	2,400	0.099	1,800	White
HC0603-24N□-S	24	2 / 5 / 10	250	42	250	2,400	0.105	1,800	Black

Note:

When ordering, please specify tolerance and packaging codes.

Tolerance: G = ± 2%, J = ± 5%, K = ± 10%

Packaging: Clear tape and reel (standard)

Test Instruments: L/Q- Agilent/HP4291A+Agilent/HPI6197A

SRF- Agilent/HP8753D

RDC- CH502BC/HP4338B

I_{rms}- For a 20 °C rise above 25 °C ambient.

Operating Temperature Range: -40 °C to +125 °C

TAPE DIMENSIONS

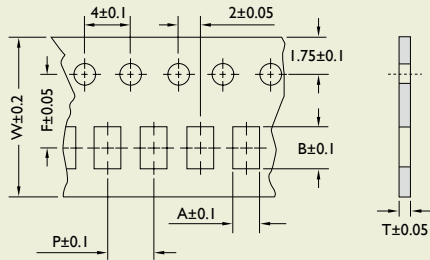

TAPE MATERIAL

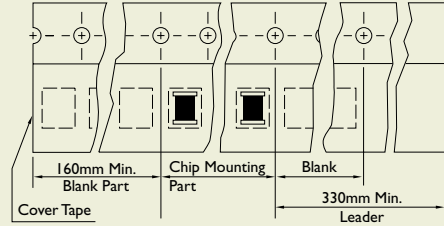

REEL DIMENSIONS

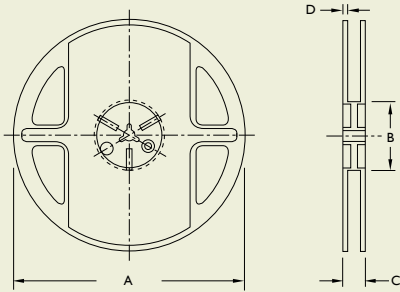

RECOMMENDED PATTERN

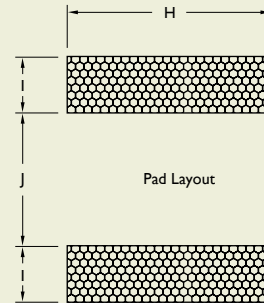

Dimensions: mm

TYPE	TAPE DIMENSIONS						RECOMMENDED PATTERN				REEL DIMENSIONS				QUANTITY/ REEL
	A	B	T	W	P	F	UNIT	H	I	J	A	B	C	D	
HC0603	1.23	1.90	0.97	8	4	3.50	inch	0.040	0.025	0.025	178	60	12	1.5	4,000
							mm	1.02	0.64	0.64					

SMD Wire Wound Chip Inductors

HQ Series



PRODUCT IDENTIFICATION

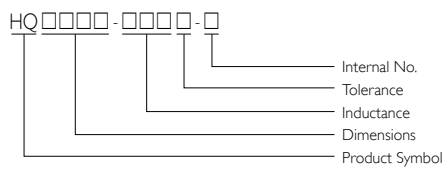

APPLICATIONS

RF products for Cellular Phone, GPS Receiver, Base Station, Repeater, Wireless LAN/Mouse/Keyboard/ Earphone, Remote Control, Security System and other RF modules.

OUTLINE

Based on our technical expertise and skill in accurately winding, these chip inductors are designed as filtering, impedance matching, resonance and choke circuits for RF designers.

The standard series as well as custom design to meet your needs of telecom & wireless products.

FEATURES

Ceramic body and wire wound construction provide highest SRFs.

These ultra-compact inductors provide exceptional Q values, even at high frequencies.

Their ceramic construction delivers the highest possible SRFs as well as excellent Q values.

The non-magnetic coil form also assures the utmost in thermal stability, predictability and batch consistency.

The highest Q factors and low RDC fulfill the needs of mobile applications.

SHAPES AND DIMENSIONS

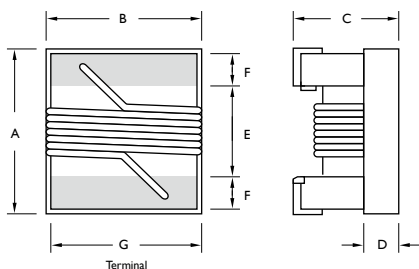

TYPE	UNIT	A	B	C	D	E	F	G
		Max.	Max.	Max.				
HQ0805	inch	0.090	0.070	0.060	0.020	0.050	0.017	0.050
	mm	2.29	1.78	1.52	0.50	1.27	0.44	1.27
HQ1008	inch	0.117	0.110	0.083	0.028	0.080	0.020	0.060
	mm	2.96	2.79	2.10	0.70	2.03	0.51	1.52

ELECTRICAL CHARACTERISTICS HQ0805

PART NO.	INDUCTANCE (nH)	TOLERANCE (±%)	TEST FREQUENCY (MHz)	Q Min.	TEST FREQUENCY (MHz)	SRF (MHz) Min.	DC RESISTANCE (Ω) Max.	I _{rms} (mA) Max.	COLOR CODING
HQ0805-2N5□-S	2.5	5 / 10	250	80	1500	6,000	0.020	1,600	Black
HQ0805-5N6□-S	5.6	5 / 10	250	98	1500	6,000	0.035	1,600	Brown
HQ0805-6N2□-S	6.2	5 / 10	250	88	1000	4,750	0.035	1,600	Red
HQ0805-12N□-S	12	5 / 10	250	80	1000	3,000	0.045	1,600	Orange
HQ0805-16N□-S	16	2 / 5 / 10	250	72	500	2,950	0.060	1,500	Yellow
HQ0805-18N□-S	18	2 / 5 / 10	250	75	500	2,550	0.060	1,400	Green
HQ0805-20N□-S	20	2 / 5 / 10	250	70	500	2,050	0.055	1,400	Blue
HQ0805-27N□-S	27	2 / 5 / 10	250	75	500	2,000	0.070	1,300	Violet
HQ0805-30N□-S	30	2 / 5 / 10	250	65	500	1,950	0.095	1,200	Gray
HQ0805-39N□-S	39	2 / 5 / 10	250	65	500	1,600	0.095	1,100	White
HQ0805-48N□-S	48	2 / 5 / 10	200	65	500	1,400	0.110	1,200	Black
HQ0805-51N□-S	51	2 / 5 / 10	200	65	500	1,400	0.120	1,000	Brown

Note:

When ordering, please specify tolerance and packaging codes.

Tolerance: G = ± 2%, J = ± 5%, K = ± 10%

Packaging: Clear tape and reel (standard)

Test Instruments: L/Q- Agilent/HP4291A+Agilent/HP16197A

SRF- Agilent/HP8753D+Agilent/HP4291A

RDC- CH502BC/HP4338B

I_{rms}- For a 15 °C rise above 25 °C ambient.

Operating Temperature Range: -40 °C to +125 °C



ELECTRICAL CHARACTERISTICS HQ1008

PART NO.	INDUCTANCE (nH)	TOLERANCE (±%)	TEST FREQUENCY (MHz)	Q Min.	TEST FREQUENCY (MHz)	SRF (MHz) Min.	DC RESISTANCE (Ω) Max.	I _{rms} (mA) Max.	COLOR CODING		
									1 st	2 nd	3 rd
HQ1008-4N□-S	4.1	5 / 10	50	75	1,500	6,000	0.05	1,600	Black	Yellow	Black
HQ1008-10N□-S	10	5 / 10	50	60	500	3,600	0.06	1,600	Brown	Black	Black
HQ1008-12N□-S	12	2 / 5 / 10	50	70	500	2,800	0.06	1,500	Brown	Red	Black
HQ1008-18N□-S	18	2 / 5 / 10	50	62	350	2,700	0.07	1,400	Brown	Gray	Black
HQ1008-22N□-S	22	2 / 5 / 10	50	62	350	2,050	0.07	1,400	Red	Red	Black
HQ1008-33N□-S	33	2 / 5 / 10	50	75	350	1,700	0.09	1,300	Orange	Orange	Black
HQ1008-39N□-S	39	2 / 5 / 10	50	75	350	1,300	0.09	1,300	Orange	White	Black
HQ1008-47N□-S	47	2 / 5 / 10	50	75	350	1,450	0.12	1,200	Yellow	Violet	Black
HQ1008-56N□-S	56	2 / 5 / 10	50	75	350	1,230	0.12	1,200	Green	Blue	Black
HQ1008-68N□-S	68	2 / 5 / 10	50	80	350	1,150	0.13	1,100	Blue	Gray	Black
HQ1008-82N□-S	82	2 / 5 / 10	50	80	350	1,060	0.16	1,100	Gray	Red	Black
HQ1008-R10□-S	100	2 / 5 / 10	50	62	350	1,000	0.16	1,000	Brown	Black	Brown
HQ1008-R12□-S	120	2 / 5 / 10	25	50	100	950	0.20	1,000	Brown	Red	Brown
HQ1008-R15□-S	150	2 / 5 / 10	25	48	100	820	0.23	1,000	Brown	Green	Brown
HQ1008-R22□-S	220	2 / 5 / 10	25	48	100	730	0.45	1,000	Red	Red	Brown
HQ1008-R27□-S	270	2 / 5 / 10	25	48	100	650	0.50	900	Red	Violet	Brown
HQ1008-R33□-S	330	2 / 5 / 10	25	48	100	570	0.65	900	Orange	Orange	Brown
HQ1008-R39□-S	390	2 / 5 / 10	25	48	100	530	0.70	900	Orange	White	Brown

Note:

When ordering, please specify tolerance and packaging codes.

Tolerance: G = ± 2%, J = ± 5%, K = ± 10%

Packaging: Clear tape and reel (standard)

Test Instruments: L/Q- Agilent/HP4291A+Agilent/HPI6197A

SRF- HP8753D/HP4291A

RDC- CH502BC/HP4338B

I_{rms}- For a 15 °C rise above 25 °C ambient.

Operating Temperature Range: -40 °C to +125 °C

Color Coding

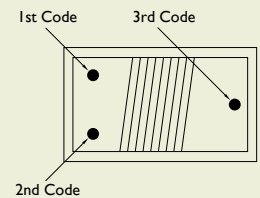

TAPE DIMENSIONS

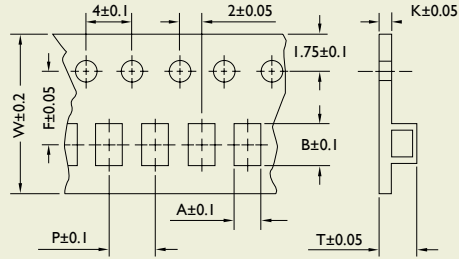

TAPE MATERIAL

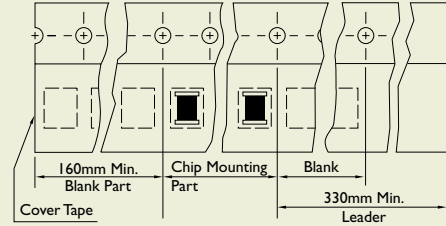

REEL DIMENSIONS

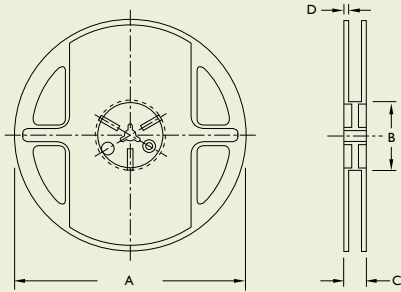

RECOMMENDED PATTERN

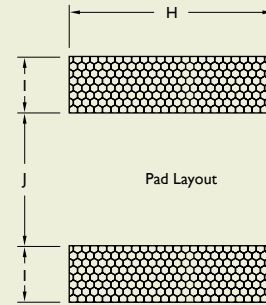

Dimensions: mm

TYPE	TAPE DIMENSIONS							RECOMMENDED PATTERN			REEL DIMENSIONS				QUANTITY/ REEL	
	A	B	T	W	P	F	K	UNIT	H	I	J	A	B	C		D
HQ0805	1.85	2.45	1.45	8	4	3.50	0.23	inch	0.070	0.040	0.030	178	60	12	1.5	2,000
								mm	1.78	1.02	0.76					
HQ1008	2.80	2.95	2.20	8	4	3.50	0.23	inch	0.100	0.040	0.050	178	60	12	1.5	2,000
								mm	2.54	1.02	1.27					

SMD Wire Wound Chip Inductors

LCN Series



PRODUCT IDENTIFICATION

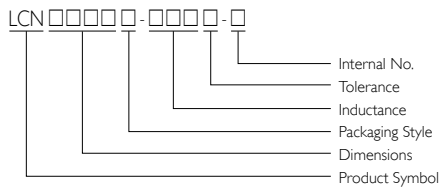

■ Packaging: T = Tape and Reel

APPLICATIONS

RF products for Cellular Phone, GPS Receiver, Base Station, Repeater, Wireless LAN/Mouse/Keyboard/ Earphone, Remote Control, Security System and other RF modules.

OUTLINE

Based on our technical expertise and skill in accurately winding, these chip inductors are designed as filtering, impedance matching, resonance and choke circuits for RF designers.

The standard series as well as custom design to meet your needs of telecom & wireless products.

FEATURES

Ceramic body and wire wound construction provide highest SRFs.

These ultra-compact inductors provide exceptional Q values, even at high frequencies.

Their ceramic construction delivers the highest possible SRFs as well as excellent Q values.

The non-magnetic coil form also assures the utmost in thermal stability, predictability and batch consistency.

LCN series has been designed especially for the needs of customer design.

SHAPES AND DIMENSIONS

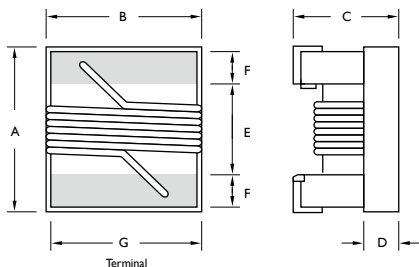

TYPE	UNIT	A	B	C	D	E	F	G
		Max.	Max.	Max.				
LCN0603	inch	0.071	0.044	0.040	0.015	0.034	0.013	0.030
	mm	1.80	1.12	1.02	0.38	0.86	0.33	0.76
LCN0805	inch	0.093	0.068	0.060	0.020	0.040	0.020	0.050
	mm	2.35	1.73	1.52	0.50	1.02	0.51	1.27
LCN1008	inch	0.115	0.110	0.083	0.020	0.060	0.020	0.080
	mm	2.92	2.79	2.10	0.51	1.52	0.51	2.03
LCN1206	inch	0.146	0.110	0.087	0.035	0.086	0.020	0.091
	mm	3.70	2.80	2.20	0.90	2.18	0.51	2.30

ELECTRICAL CHARACTERISTICS LCN0603

PART NO.	INDUCTANCE (nH)	TOLERANCE (±%)	TEST FREQUENCY (MHz)	Q Min.	SRF (MHz) Min.	DC RESISTANCE (Ω) Max.	I _{rms} (mA) Max.	900MHz		1.7GHz		COLOR CODING
								L Typ.	Q Typ.	L Typ.	Q Typ.	
LCN0603T-1N6□-S	1.6	5 / 10	250	24	12,500	0.030	700	1.60	49	1.58	63	Red
LCN0603T-1N8□-S	1.8	5 / 10	250	16	12,500	0.045	700	1.60	35	1.66	50	Black
LCN0603T-3N6□-S	3.6	5 / 10	250	22	5,900	0.063	700	3.70	53	3.71	65	Red
LCN0603T-3N9□-S	3.9	5 / 10	250	22	6,900	0.080	700	3.95	49	3.96	67	Brown
LCN0603T-4N3□-S	4.3	5 / 10	250	22	5,900	0.063	700	4.32	50	4.33	70	Orange
LCN0603T-4N7□-S	4.7	5 / 10	250	20	5,800	0.116	700	4.72	47	4.75	57	Violet
LCN0603T-5N1□-S	5.1	5 / 10	250	20	5,700	0.140	700	4.93	47	4.95	56	Green
LCN0603T-6N3□-S	6.3	5 / 10	250	20	5,700	0.140	700	5.50	47	6.10	60	White
LCN0603T-6N8□-S	6.8	5 / 10	250	27	5,800	0.110	700	6.75	60	7.10	81	Red
LCN0603T-7N5□-S	7.5	5 / 10	250	28	4,800	0.106	700	7.70	60	7.82	65	Brown
LCN0603T-8N2□-S	8.2	5 / 10	250	28	4,700	0.109	700	8.30	60	8.50	60	White
LCN0603T-8N7□-S	8.7	5 / 10	250	28	4,600	0.109	700	8.86	62	9.32	58	Yellow
LCN0603T-9N5□-S	9.5	5 / 10	250	28	5,400	0.135	700	9.70	59	9.92	61	Blue
LCN0603T-10N□-S	10	2 / 5 / 10	250	31	4,800	0.130	700	10.0	66	10.6	83	Orange
LCN0603T-11N□-S	11	2 / 5 / 10	250	33	4,000	0.086	700	11.0	53	11.5	56	Gray
LCN0603T-12N□-S	12	2 / 5 / 10	250	35	4,000	0.130	700	12.3	72	13.5	83	Yellow
LCN0603T-15N□-S	15	2 / 5 / 10	250	35	4,000	0.170	700	15.4	64	16.8	89	Green
LCN0603T-16N□-S	16	2 / 5 / 10	250	34	3,300	0.104	700	16.2	55	17.3	52	White
LCN0603T-18N□-S	18	2 / 5 / 10	250	35	3,100	0.170	700	18.7	70	21.4	69	Blue
LCN0603T-22N□-S	22	2 / 5 / 10	250	38	3,000	0.190	700	22.8	73	26.1	71	Violet
LCN0603T-24N□-S	24	2 / 5 / 10	250	37	2,650	0.135	700	24.5	45	28.7	39	Black
LCN0603T-27N□-S	27	2 / 5 / 10	250	40	2,800	0.220	600	29.2	74	34.6	65	Gray
LCN0603T-30N□-S	30	2 / 5 / 10	250	37	2,250	0.144	600	31.4	47	39.9	28	Brown
LCN0603T-33N□-S	33	2 / 5 / 10	250	40	2,300	0.220	600	36.0	67	49.5	42	White
LCN0603T-36N□-S	36	2 / 5 / 10	250	38	2,080	0.250	600	39.4	47	52.7	24	Red
LCN0603T-39N□-S	39	2 / 5 / 10	250	40	2,200	0.250	600	42.7	60	60.2	40	Black
LCN0603T-43N□-S	43	2 / 5 / 10	250	39	2,000	0.280	600	47.0	44	64.9	21	Orange
LCN0603T-47N□-S	47	2 / 5 / 10	200	38	2,000	0.280	600	52.2	62	77.2	35	Brown
LCN0603T-56N□-S	56	2 / 5 / 10	200	38	1,900	0.310	600	62.5	56	97	26	Red
LCN0603T-68N□-S	68	2 / 5 / 10	200	37	1,700	0.340	600	80.5	54	168	21	Orange
LCN0603T-72N□-S	72	2 / 5 / 10	150	34	1,700	0.490	400	82.0	53	135	20	Yellow
LCN0603T-82N□-S	82	2 / 5 / 10	150	34	1,700	0.540	400	96.2	54	177	21	Green
LCN0603T-R10□-S	100	2 / 5 / 10	150	34	1,400	0.580	400	124	49	-	-	Blue
LCN0603T-R11□-S	110	2 / 5 / 10	150	32	1,350	0.610	300	138	43	-	-	Violet
LCN0603T-R12□-S	120	2 / 5 / 10	150	32	1,300	0.750	300	166	39	-	-	Gray
LCN0603T-R15□-S	150	2 / 5 / 10	150	28	990	0.920	280	250	25	-	-	White
LCN0603T-R18□-S	180	2 / 5 / 10	100	25	990	1.250	240	305	22	-	-	Black
LCN0603T-R22□-S	220	2 / 5 / 10	100	25	900	2.100	200	480	8	-	-	Brown
LCN0603T-R27□-S	270	2 / 5 / 10	100	24	900	2.300	170	980	4	-	-	Red

Note:

When ordering, please specify tolerance and packaging codes.

Tolerance: G = ± 2%, J = ± 5%, K = ± 10%

Packaging: Clear tape and reel (standard)

Test Instruments: L/Q- Agilent/HP4291A+Agilent/HP16197A

SRF- HP8753D/HP4291A

RDC- CH502BC/HP4338B

I_{rms}- For a 15 °C rise above 25 °C ambient.

Operating Temperature Range: -40 °C to +125 °C



ELECTRICAL CHARACTERISTICS LCN0805

PART NO.	INDUCTANCE (nH)	TOLERANCE (±%)	TEST FREQUENCY (MHz)	Q Min.	TEST FREQUENCY (MHz)	SRF (MHz) Min.	DC RESISTANCE (Ω) Max.	I _{rms} (mA) Max.	COLOR CODING
LCN0805T-2N8□-S	2.8	5 / 10	250	70	1500	7,900	0.06	800	Gray
LCN0805T-3N0□-S	3.0	5 / 10	250	65	1500	7,900	0.06	800	White
LCN0805T-3N3□-S	3.3	5 / 10	250	50	1500	7,900	0.08	600	Black
LCN0805T-5N6□-S	5.6	5 / 10	250	65	1000	5,500	0.08	600	Orange
LCN0805T-6N8□-S	6.8	5 / 10	250	50	1000	5,500	0.11	600	Brown
LCN0805T-7N5□-S	7.5	5 / 10	250	50	1000	4,500	0.14	600	Green
LCN0805T-8N2□-S	8.2	5 / 10	250	50	1000	4,700	0.12	600	Red
LCN0805T-10N□-S	10	2 / 5 / 10	250	60	500	4,200	0.10	600	Blue
LCN0805T-12N□-S	12	2 / 5 / 10	250	50	500	4,000	0.15	600	Orange
LCN0805T-15N□-S	15	2 / 5 / 10	250	50	500	3,400	0.17	600	Yellow
LCN0805T-18N□-S	18	2 / 5 / 10	250	50	500	3,300	0.20	600	Green
LCN0805T-22N□-S	22	2 / 5 / 10	250	55	500	2,600	0.22	500	Blue
LCN0805T-24N□-S	24	2 / 5 / 10	250	50	500	2,000	0.22	500	Gray
LCN0805T-27N□-S	27	2 / 5 / 10	250	55	500	2,500	0.25	500	Violet
LCN0805T-33N□-S	33	2 / 5 / 10	250	60	500	2,050	0.27	500	Gray
LCN0805T-36N□-S	36	2 / 5 / 10	250	55	500	1,700	0.27	500	Orange
LCN0805T-39N□-S	39	2 / 5 / 10	250	60	500	2,000	0.29	500	White
LCN0805T-43N□-S	43	2 / 5 / 10	200	60	500	1,650	0.34	500	Yellow
LCN0805T-47N□-S	47	2 / 5 / 10	200	60	500	1,650	0.31	500	Black
LCN0805T-56N□-S	56	2 / 5 / 10	200	60	500	1,550	0.34	500	Brown
LCN0805T-68N□-S	68	2 / 5 / 10	200	60	500	1,450	0.38	500	Red
LCN0805T-82N□-S	82	2 / 5 / 10	150	65	500	1,300	0.42	400	Orange
LCN0805T-91N□-S	91	2 / 5 / 10	150	65	500	1,200	0.48	400	Black
LCN0805T-R10□-S	100	2 / 5 / 10	150	65	500	1,200	0.46	400	Yellow
LCN0805T-R11□-S	110	2 / 5 / 10	150	50	250	1,000	0.48	400	Brown
LCN0805T-R12□-S	120	2 / 5 / 10	150	50	250	1,100	0.51	400	Green
LCN0805T-R15□-S	150	2 / 5 / 10	100	50	250	920	0.56	400	Blue
LCN0805T-R18□-S	180	2 / 5 / 10	100	50	250	870	0.64	400	Violet
LCN0805T-R20□-S	200	2 / 5 / 10	100	50	250	860	0.70	400	Red
LCN0805T-R22□-S	220	2 / 5 / 10	100	50	250	850	0.70	400	Gray
LCN0805T-R24□-S	240	2 / 5 / 10	100	44	250	690	1.00	350	Red
LCN0805T-R25□-S	250	2 / 5 / 10	100	45	250	660	1.00	350	Yellow
LCN0805T-R27□-S	270	2 / 5 / 10	100	48	250	650	1.00	350	White
LCN0805T-R33□-S	330	2 / 5 / 10	100	48	250	600	1.40	310	Black
LCN0805T-R39□-S	390	2 / 5 / 10	100	25	250	400	1.50	290	Brown
LCN0805T-R47□-S	470	2 / 5 / 10	50	33	100	400	1.76	250	Violet
LCN0805T-R56□-S	560	2 / 5 / 10	25	20	50	200	1.90	230	Orange
LCN0805T-R68□-S	680	2 / 5 / 10	25	18	50	130	2.20	190	Green
LCN0805T-R82□-S	820	2 / 5 / 10	25	15	50	100	2.35	180	Blue

Note:

When ordering, please specify tolerance and packaging codes.

Tolerance: G = ± 2%, J = ± 5%, K = ± 10%

Packaging: Clear tape and reel (standard)

Test Instruments: L/Q- Agilent/HP4291A+Agilent/HP16197A

SRF- HP8753D/HP4291A

RDC- CH502BC/HP4338B

I_{rms}- For a 15 °C rise above 25 °C ambient.

Operating Temperature Range: -40 °C to +125 °C

ELECTRICAL CHARACTERISTICS LCN1008

PART NO.	INDUCTANCE (nH)	TOLERANCE (±%)	TEST FREQUENCY (MHz)	Q Min.	TEST FREQUENCY (MHz)	SRF (MHz) Min.	DC RESISTANCE (Ω) Max.	I _{rms} (mA) Max.	COLOR CODING		
									1 st	2 nd	3 rd
LCN1008T-10N□-S	10	2 / 5 / 10	50	50	500	4,100	0.08	1,000	Brown	Black	Black
LCN1008T-12N□-S	12	2 / 5 / 10	50	50	500	3,300	0.09	1,000	Brown	Red	Black
LCN1008T-15N□-S	15	2 / 5 / 10	50	50	500	2,500	0.10	1,000	Brown	Green	Black
LCN1008T-18N□-S	18	2 / 5 / 10	50	50	350	2,500	0.11	1,000	Brown	Gray	Black
LCN1008T-22N□-S	22	2 / 5 / 10	50	55	350	2,400	0.12	1,000	Red	Red	Black
LCN1008T-27N□-S	27	2 / 5 / 10	50	55	350	1,600	0.13	1,000	Red	Violet	Black
LCN1008T-33N□-S	33	2 / 5 / 10	50	60	350	1,600	0.14	1,000	Orange	Orange	Black
LCN1008T-39N□-S	39	2 / 5 / 10	50	60	350	1,500	0.15	1,000	Orange	White	Black
LCN1008T-47N□-S	47	2 / 5 / 10	50	65	350	1,500	0.16	1,000	Yellow	Violet	Black
LCN1008T-56N□-S	56	2 / 5 / 10	50	65	350	1,300	0.18	1,000	Green	Blue	Black
LCN1008T-68N□-S	68	2 / 5 / 10	50	65	350	1,300	0.20	1,000	Blue	Gray	Black
LCN1008T-82N□-S	82	2 / 5 / 10	50	60	350	1,000	0.22	1,000	Gray	Red	Black
LCN1008T-R10□-S	100	2 / 5 / 10	25	60	350	1,000	0.56	650	Brown	Black	Brown
LCN1008T-R12□-S	120	2 / 5 / 10	25	60	350	950	0.63	650	Brown	Red	Brown
LCN1008T-R15□-S	150	2 / 5 / 10	25	45	100	850	0.70	580	Brown	Green	Brown
LCN1008T-R18□-S	180	2 / 5 / 10	25	45	100	750	0.77	620	Brown	Gray	Brown
LCN1008T-R22□-S	220	2 / 5 / 10	25	45	100	700	0.84	500	Red	Red	Brown
LCN1008T-R27□-S	270	2 / 5 / 10	25	45	100	600	0.91	500	Red	Violet	Brown
LCN1008T-R33□-S	330	2 / 5 / 10	25	45	100	570	1.05	450	Orange	Orange	Brown
LCN1008T-R39□-S	390	2 / 5 / 10	25	45	100	500	1.12	470	Orange	White	Brown
LCN1008T-R47□-S	470	2 / 5 / 10	25	45	100	450	1.19	470	Yellow	Violet	Brown
LCN1008T-R56□-S	560	2 / 5 / 10	25	45	100	415	1.33	400	Green	Blue	Brown
LCN1008T-R62□-S	620	2 / 5 / 10	25	45	100	375	1.40	300	Blue	Red	Brown
LCN1008T-R68□-S	680	2 / 5 / 10	25	45	100	375	1.47	400	Blue	Gray	Brown
LCN1008T-R75□-S	750	2 / 5 / 10	25	45	100	360	1.54	360	Violet	Green	Brown
LCN1008T-R82□-S	820	2 / 5 / 10	25	45	100	350	1.61	400	Gray	Red	Brown
LCN1008T-R91□-S	910	2 / 5 / 10	25	35	50	320	1.68	380	White	Brown	Brown
LCN1008T-1R0□-S	1,000	2 / 5 / 10	25	35	50	220	1.75	370	Brown	Black	Red
LCN1008T-1R2□-S	1,200	2 / 5 / 10	7.90	35	50	186	2.00	310	Brown	Red	Red
LCN1008T-1R5□-S	1,500	2 / 5 / 10	7.90	28	50	200	2.30	330	Brown	Green	Red
LCN1008T-1R8□-S	1,800	2 / 5 / 10	7.90	25	50	170	2.60	300	Brown	Gray	Red
LCN1008T-2R2□-S	2,200	2 / 5 / 10	7.90	20	50	110	2.80	280	Red	Red	Red
LCN1008T-2R7□-S	2,700	2 / 5 / 10	7.90	15	25	140	3.20	290	Red	Violet	Red
LCN1008T-3R3□-S	3,300	2 / 5 / 10	7.90	15	25	100	3.40	290	Orange	Orange	Red
LCN1008T-3R9□-S	3,900	2 / 5 / 10	7.90	15	25	100	3.60	260	Orange	White	Red
LCN1008T-4R7□-S	4,700	2 / 5 / 10	7.90	13	25	90	4.00	260	Yellow	Violet	Red
LCN1008T-5R6□-S	5,600	2 / 5 / 10	7.90	16	7.9	20	4.00	240	Green	Yellow	Red
LCN1008T-6R8□-S	6,800	2 / 5 / 10	7.90	18	7.9	40	4.90	200	Yellow	Gray	Red
LCN1008T-8R2□-S	8,200	2 / 5 / 10	7.90	18	7.9	25	6.00	170	Gray	Red	Red

Note:
 When ordering, please specify tolerance and packaging codes.
 Tolerance: G = ± 2%, J = ± 5%, K = ± 10%
 Packaging: Clear tape and reel (standard)
 Test Instruments: L/Q- Agilent/HP4291A+Agilent/HP16197A
 SRF- HP8753D/HP4291A
 RDC- CH502BC/HP4338B
 I_{rms}- For a 15 °C rise above 25 °C ambient.
 Operating Temperature Range: -40 °C to +125 °C

Color Coding

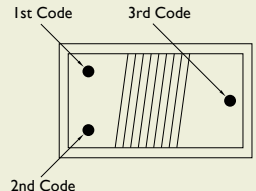



ELECTRICAL CHARACTERISTICS LCN1206

PART NO.	INDUCTANCE (nH)	TOLERANCE (±%)	TEST FREQUENCY (MHz)	Q Min.	TEST FREQUENCY (MHz)	SRF (MHz) Min.	DC RESISTANCE (Ω) Max.	I _{rms} (mA) Max.	COLOR CODING		
									1 st	2 nd	3 rd
LCN1206T-3N3□-S	3.3	5 / 10	100	30	300	6,200	0.05	1,000	Black	Orange	Black
LCN1206T-6N8□-S	6.8	5 / 10	100	30	300	5,500	0.07	1,000	Black	Blue	Black
LCN1206T-10N□-S	10	2 / 5 / 10	100	40	300	4,000	0.08	1,000	Brown	Black	Black
LCN1206T-12N□-S	12	2 / 5 / 10	100	40	300	3,200	0.08	1,000	Brown	Red	Black
LCN1206T-15N□-S	15	2 / 5 / 10	100	40	300	3,200	0.10	1,000	Brown	Green	Black
LCN1206T-18N□-S	18	2 / 5 / 10	100	50	300	2,800	0.10	1,000	Brown	Gray	Black
LCN1206T-22N□-S	22	2 / 5 / 10	100	50	300	2,200	0.10	1,000	Red	Red	Black
LCN1206T-27N□-S	27	2 / 5 / 10	100	50	300	1,800	0.11	1,000	Red	Violet	Black
LCN1206T-33N□-S	33	2 / 5 / 10	100	55	300	1,800	0.11	1,000	Orange	Orange	Black
LCN1206T-39N□-S	39	2 / 5 / 10	100	55	300	1,800	0.12	1,000	Orange	White	Black
LCN1206T-47N□-S	47	2 / 5 / 10	100	55	300	1,500	0.13	1,000	Yellow	Violet	Black
LCN1206T-56N□-S	56	2 / 5 / 10	100	55	300	1,450	0.14	1,000	Green	Blue	Black
LCN1206T-68N□-S	68	2 / 5 / 10	100	55	300	1,200	0.26	900	Blue	Gray	Black
LCN1206T-82N□-S	82	2 / 5 / 10	100	55	300	1,200	0.21	900	Gray	Red	Black
LCN1206T-R10□-S	100	2 / 5 / 10	100	55	300	1,100	0.26	850	Brown	Black	Brown
LCN1206T-R12□-S	120	2 / 5 / 10	100	60	300	1,100	0.26	800	Brown	Red	Brown
LCN1206T-R15□-S	150	2 / 5 / 10	100	60	300	950	0.31	750	Brown	Green	Brown
LCN1206T-R18□-S	180	2 / 5 / 10	50	60	300	900	0.43	700	Brown	Gray	Brown
LCN1206T-R22□-S	220	2 / 5 / 10	50	60	300	760	0.50	670	Red	Red	Brown
LCN1206T-R27□-S	270	2 / 5 / 10	50	55	300	730	0.56	630	Red	Violet	Brown
LCN1206T-R33□-S	330	2 / 5 / 10	50	45	150	650	0.62	590	Orange	Orange	Brown
LCN1206T-R39□-S	390	2 / 5 / 10	50	45	150	600	0.75	530	Orange	White	Brown
LCN1206T-R47□-S	470	2 / 5 / 10	50	45	150	550	1.30	490	Yellow	Violet	Brown
LCN1206T-R56□-S	560	2 / 5 / 10	35	45	150	470	1.34	460	Green	Blue	Brown
LCN1206T-R62□-S	620	2 / 5 / 10	35	45	150	470	1.58	460	Blue	Red	Brown
LCN1206T-R68□-S	680	2 / 5 / 10	35	45	150	450	1.58	430	Blue	Gray	Brown
LCN1206T-R75□-S	750	2 / 5 / 10	35	45	150	440	2.25	320	Violet	Green	Brown
LCN1206T-R82□-S	820	2 / 5 / 10	35	45	150	420	1.82	400	Gray	Red	Brown
LCN1206T-R91□-S	910	2 / 5 / 10	35	45	150	410	2.95	310	White	Brown	Brown
LCN1206T-1R0□-S	1,000	2 / 5 / 10	35	45	150	400	2.80	320	Brown	Black	Red
LCN1206T-1R2□-S	1,200	2 / 5 / 10	35	45	150	380	3.20	300	Brown	Red	Red

Note:

When ordering, please specify tolerance and packaging codes.

Tolerance: G = ± 2%, J = ± 5%, K = ± 10%

Packaging: Clear tape and reel (standard)

Test Instruments: L/Q- Agilent/HP4291A+Agilent/HPI 6197A

SRF- HP8753D/HP4291A

RDC- CH502BC/HP4338B

I_{rms}- For a 15 °C rise above 25 °C ambient.

Operating Temperature Range: -40 °C to +125 °C

Color Coding

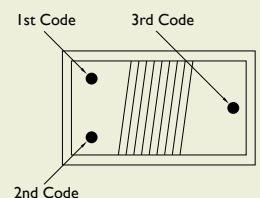

TAPE DIMENSIONS

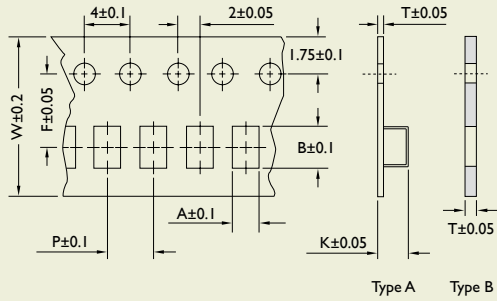

TAPE MATERIAL

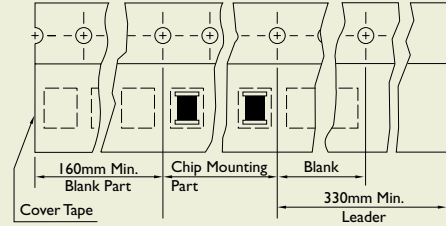

REEL DIMENSIONS

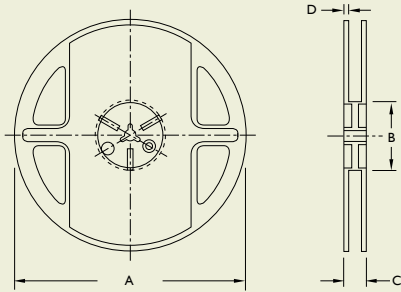

RECOMMENDED PATTERN

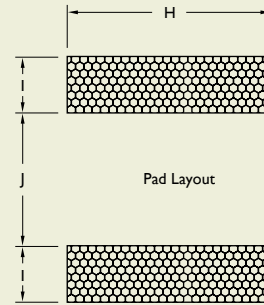

Dimensions: mm

TYPE	TAPE DIMENSIONS								TAPE TYPE	RECOMMENDED PATTERN			REEL DIMENSIONS				QUANTITY/ REEL
	A	B	T	W	P	F	K	UNIT		H	I	J	A	B	C	D	
LCN0603	1.23	1.90	0.97	8	4	3.50	-	B	inch	0.040	0.025	0.025	178	60	12	1.5	4,000
									mm	1.02	0.64	0.64					
LCN0805	1.85	2.45	0.23	8	4	3.50	1.45	A	inch	0.070	0.040	0.030	178	60	12	1.5	2,500
									mm	1.78	1.02	0.76					
LCN1008	2.80	2.95	0.23	8	4	3.50	2.20	A	inch	0.100	0.040	0.050	178	60	12	1.5	2,000
									mm	2.54	1.02	1.27					
LCN1206	2.95	3.85	0.25	12	4	5.50	2.45	A	inch	0.106	0.039	0.079	178	60	16	1.4	2,000
									mm	2.70	1.00	2.00					

SMD Wire Wound Chip Inductors

CMM Series



PRODUCT IDENTIFICATION

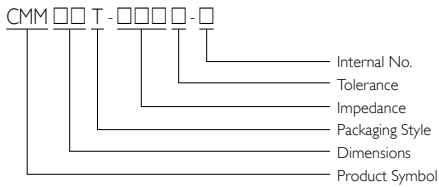

- Packaging: T = Tape and Reel
- Internal No.: N = Lead-Free

APPLICATIONS

USB line for personal computers and peripherals.

IEEE 1394 line for personal computers, DVC, STB.

LVDS, panel line for liquid display panels, graphic card etc.

OUTLINE

Based on Yageo's technical expertise, we have introduced a full series of common mode choke.

They are designed for excellent noise attenuation with a compact size for wide applications such as USB line for personal computers and peripherals, IEEE 1394 line for personal computers, DVC, STB and LVDS, panel line for liquid display panels, etc.

We welcome you to contact us for any requirements from our standard series, or for custom design service.

FEATURES

Miniature SMD type common mode filter for fully automated assembly.

Wide Impedance range (30 Ω to 900 Ω) for noise suppression.

Excellent Solderability

SHAPES AND DIMENSIONS

Unit: mm

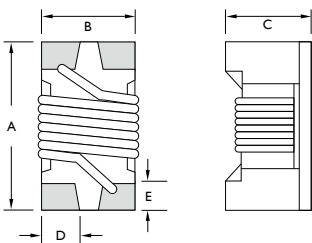

TYPE	A	B	C	D	E
CMM21	2.05 ± 0.2	1.25 ± 0.2	1.20 ± 0.2	0.50	0.58

ELECTRICAL CHARACTERISTICS

PART NO.	IMPEDANCE (Ω)	TOLERANCE ($\pm\%$)	TEST FREQUENCY (MHz)	RATED VOLTAGE (Vdc)	DC RESISTANCE (Ω) Max.	IDC (mA) Max.	INSULATION RESISTANCE (M Ω) Min.
CMM21T-300M-N	30	20	100	50	0.20	450	10
CMM21T-670M-N	67	20	100	50	0.25	400	10
CMM21T-900M-N	90	20	100	50	0.35	330	10
CMM21T-121M-N	120	20	100	50	0.30	370	10
CMM21T-161M-N	160	20	100	50	0.40	300	10
CMM21T-181M-N	180	20	100	50	0.35	330	10
CMM21T-201M-N	200	20	100	50	0.35	330	10
CMM21T-221M-N	220	20	100	50	0.35	310	10
CMM21T-261M-N	260	20	100	50	0.40	300	10
CMM21T-301M-N	300	20	100	50	0.40	290	10
CMM21T-361M-N	360	20	100	50	0.45	280	10
CMM21T-371M-N	370	20	100	50	0.45	280	10
CMM21T-501M-N	500	20	100	50	0.55	170	10
CMM21T-671M-N	670	20	100	50	0.60	140	10
CMM21T-901M-N	900	20	100	50	0.60	80	10

Note:

When ordering, please specify tolerance and packaging codes.

Tolerance: M = $\pm 20\%$

Packaging: Clear tape and reel (standard)

Test Instruments: Z- Agilent/HP4291A

RDC(Single line)- CH502BC/HP4338B

Insulation Resistance: Agilent/HP4339B

Operating Temperature Range: -25 °C to +85 °C



TAPE DIMENSIONS

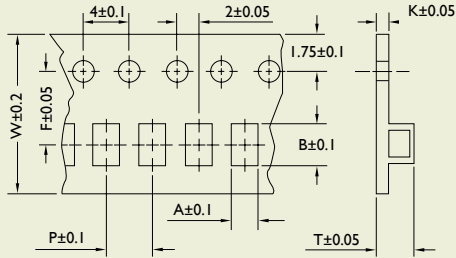

TAPE MATERIAL

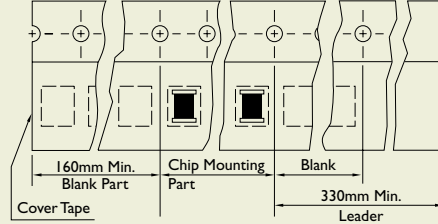

REEL DIMENSIONS

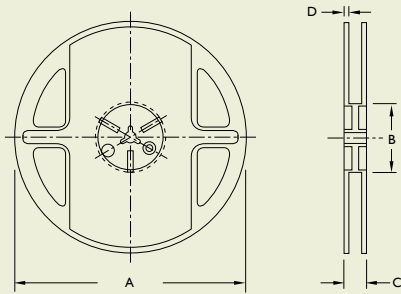

RECOMMENDED PATTERN

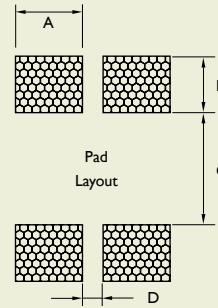

Dimensions: mm

TYPE	TAPE DIMENSIONS							RECOMMENDED PATTERN				REEL DIMENSIONS				QUANTITY/ REEL
	A	B	T	W	P	F	K	A	B	C	D	A	B	C	D	
CMM21	1.50	2.25	1.45	8	4	3.50	0.24	0.50	1.20	0.80	2.60	178	60	12	1.5	2000

SSL04LP Series

SMD Power Inductors

APPLICATIONS

Notebook Computers, Step-up and Step-down Converters

Flash Memory Programmers, etc.

FEATURES

High Energy Storage and Very Low Resistance

Smallest Size and High Performance

ELECTRICAL CHARACTERISTICS

PART NO.	INDUCTANCE * (μ H)	TOLERANCE (\pm %)	DC RESISTANCE (Ω) Max.	Isat ** (A)	Irms *** (A)
SSL04LP-1R2M-N	1.2	20	0.08	2.10	3.60
SSL04LP-1R5M-N	1.5	20	0.10	1.90	2.80
SSL04LP-2R2M-N	2.2	20	0.12	1.60	2.40
SSL04LP-3R3M-N	3.3	20	0.16	1.30	2.00
SSL04LP-4R7M-N	4.7	20	0.20	1.10	1.70
SSL04LP-6R8M-N	6.8	20	0.32	0.90	1.20
SSL04LP-100M-N	10	20	0.41	0.80	1.10
SSL04LP-150M-N	15	20	0.55	0.65	0.90
SSL04LP-220M-N	22	20	0.85	0.50	0.83
SSL04LP-330M-N	33	20	1.30	0.40	0.62
SSL04LP-470M-N	47	20	1.80	0.35	0.52
SSL04LP-680M-N	68	20	2.50	0.30	0.35
SSL04LP-101M-N	100	20	3.50	0.25	0.27
SSL04LP-151M-N	150	20	5.00	0.18	0.24
SSL04LP-221M-N	220	20	7.00	0.16	0.23
SSL04LP-331M-N	330	20	15.0	0.13	0.13

Note:

*Inductance Tested at 100 KHz, 0.1 Vrms.

*** Δ T = 40 °C Rise Typ at Irms.

**Inductance Drop = 10% Typ. at Isat.

Operating Temperature Range: -40 °C to +85 °C



PRODUCT IDENTIFICATION

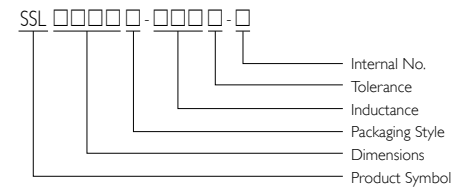

■ Packaging: T = Tape and Reel, B = Bulk

■ Internal No.: N = Lead-Free

SHAPES AND DIMENSIONS

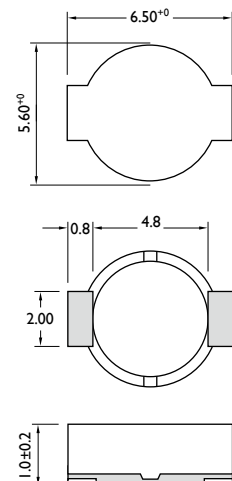

Dimensions: mm

SMD Power Inductors

SSL0400 Series



PRODUCT IDENTIFICATION

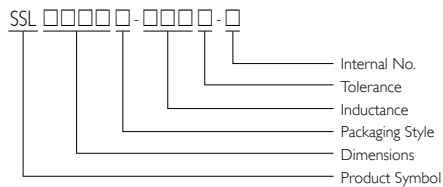

- Packaging: T = Tape and Reel, B = Bulk
- Internal No.: N = Lead-Free

SHAPES AND DIMENSIONS

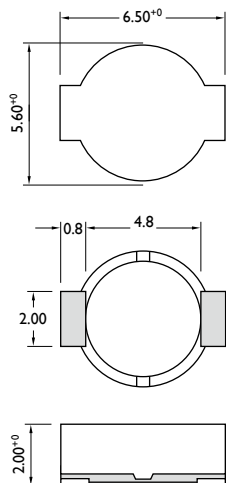

APPLICATIONS

Notebook Computers, Step-up and Step-down Converters

Flash Memory Programmers, etc.

FEATURES

High Energy Storage and Very Low Resistance

Smallest Size and High Performance

ELECTRICAL CHARACTERISTICS

PART NO.	INDUCTANCE * (μ H)	TOLERANCE (\pm %)	DC RESISTANCE (Ω) Max.	Isat ** (A)	Irms *** (A)
SSL0400T-1R0M-N	1.0	20	0.05	2.50	2.30
SSL0400T-1R5M-N	1.5	20	0.06	2.20	2.10
SSL0400T-2R2M-N	2.2	20	0.07	1.80	1.70
SSL0400T-3R3M-N	3.3	20	0.12	1.40	1.30
SSL0400T-4R7M-N	4.7	20	0.15	1.20	1.10
SSL0400T-6R8M-N	6.8	20	0.20	1.10	1.00
SSL0400T-100M-N	10	20	0.30	1.00	0.90
SSL0400T-150M-N	15	20	0.40	0.80	0.70
SSL0400T-220M-N	22	20	0.54	0.60	0.50
SSL0400T-330M-N	33	20	0.74	0.50	0.45
SSL0400T-470M-N	47	20	1.10	0.45	0.40
SSL0400T-680M-N	68	20	1.60	0.35	0.35
SSL0400T-101M-N	100	20	2.30	0.30	0.30
SSL0400T-151M-N	150	20	3.50	0.25	0.25
SSL0400T-221M-N	220	20	5.70	0.20	0.18
SSL0400T-331M-N	330	20	8.20	0.16	0.16
SSL0400T-471M-N	470	20	10.8	0.14	0.12
SSL0400T-681M-N	680	20	17.2	0.12	0.10
SSL0400T-102M-N	1000	20	22.6	0.08	0.08

Note:

*Inductance Tested at 100 KHz, 0.1 Vrms.

*** Δ T = 40 °C Rise Typ at Irms.

**Inductance Drop = 10% Typ. at Isat.

Operating Temperature Range: -40 °C to +85 °C

SSL0402 Series

SMD Power Inductors

APPLICATIONS

Notebook Computers, Step-up and Step-down Converters

Flash Memory Programmers, etc.

FEATURES

High Energy Storage and Very Low Resistance

Smallest Size and High Performance

ELECTRICAL CHARACTERISTICS

PART NO.	INDUCTANCE * (μ H)	TOLERANCE (\pm %)	SRF (MHz) Typ.	DC RESISTANCE (Ω) Max.	Isat ** (A)	I _{rms} *** (A)
SSL0402T-1R0M-N	1.0	20	130	0.05	2.90	2.90
SSL0402T-1R5M-N	1.5	20	115	0.05	2.60	2.80
SSL0402T-2R2M-N	2.2	20	90	0.07	2.30	2.40
SSL0402T-3R3M-N	3.3	20	70	0.08	2.00	2.00
SSL0402T-4R7M-N	4.7	20	50	0.09	1.50	1.50
SSL0402T-6R8M-N	6.8	20	45	0.13	1.20	1.40
SSL0402T-100M-N	10	20	35	0.16	1.10	1.10
SSL0402T-150M-N	15	20	30	0.23	0.90	1.20
SSL0402T-220M-N	22	20	20	0.37	0.70	0.80
SSL0402T-330M-N	33	20	15	0.51	0.58	0.60
SSL0402T-470M-N	47	20	14	0.64	0.50	0.50
SSL0402T-680M-N	68	20	11	0.86	0.40	0.40
SSL0402T-101M-N	100	20	9.0	1.27	0.31	0.30
SSL0402T-151M-N	150	20	6.0	2.00	0.27	0.25
SSL0402T-221M-N	220	20	5.5	3.11	0.22	0.20
SSL0402T-331M-N	330	20	5.0	3.80	0.18	0.16
SSL0402T-471M-N	470	20	4.0	5.06	0.16	0.15
SSL0402T-681M-N	680	20	3.0	9.20	0.14	0.12
SSL0402T-102M-N	1000	20	2.0	13.8	0.10	0.07

Note:

*Inductance Tested at 100 KHz, 0.1 Vrms.

*** Δ T = 30 °C Rise Typ at I_{rms}.

**Inductance Drop = 20% Typ. at Isat.

Operating Temperature Range: -40 °C to +85 °C



PRODUCT IDENTIFICATION

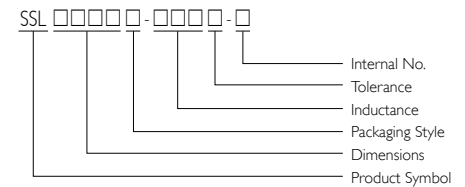

■ Packaging: T = Tape and Reel, B = Bulk

■ Internal No.: N = Lead-Free

SHAPES AND DIMENSIONS

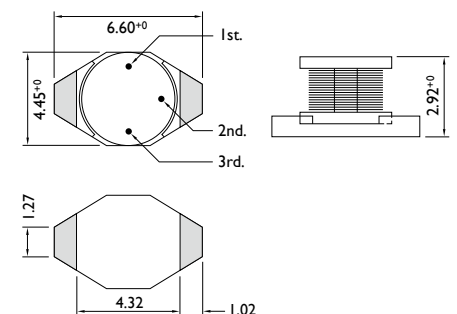

Dimensions: mm

SMD Power Inductors

SSL0614 Series



PRODUCT IDENTIFICATION

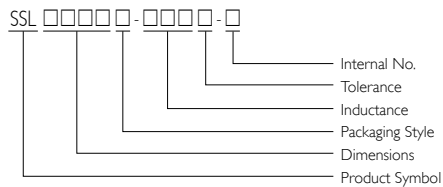

- Packaging: T = Tape and Reel, B = Bulk
- Internal No.: N = Lead-Free

SHAPES AND DIMENSIONS

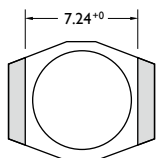
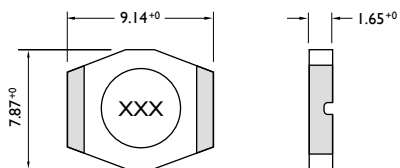

Dimensions: mm

APPLICATIONS

Notebook Computers, Step-up and Step-down Converters

Flash Memory Programmers, etc.

FEATURES

High Energy Storage and Very Low Resistance

Smallest Size and High Performance

ELECTRICAL CHARACTERISTICS

PART NO.	INDUCTANCE * (μ H)	TOLERANCE (\pm %)	DC RESISTANCE (Ω) Max.	I _{rms} ** (A)
SSL0614T-4R7M-N	4.7	20	0.145	1.60
SSL0614T-6R8M-N	6.8	20	0.165	1.30
SSL0614T-100M-N	10	20	0.240	1.00
SSL0614T-150M-N	15	20	0.300	0.90
SSL0614T-220M-N	22	20	0.420	0.70
SSL0614T-330M-N	33	20	0.550	0.60
SSL0614T-470M-N	47	20	0.765	0.40
SSL0614T-680M-N	68	20	1.10	0.40
SSL0614T-101M-N	100	20	1.60	0.30
SSL0614T-151M-N	150	20	2.50	0.25
SSL0614T-221M-N	220	20	3.65	0.22
SSL0614T-331M-N	330	20	4.65	0.18
SSL0614T-471M-N	470	20	6.75	0.14
SSL0614T-681M-N	680	20	9.15	0.12
SSL0614T-102M-N	1000	20	14.2	0.10

Note:

*Inductance Tested at 100 KHz, 0.1 Vrms.

**Inductance Drop = 10% Typ. at Isat.

Operating Temperature Range: -40 °C to +85 °C

SSL0802 Series

SMD Power Inductors

APPLICATIONS

Notebook Computers, Step-up and Step-down Converters

Flash Memory Programmers, etc.

FEATURES

High Energy Storage and Very Low Resistance

Smallest Size and High Performance

ELECTRICAL CHARACTERISTICS

PART NO.	INDUCTANCE * (μ H)	TOLERANCE (\pm %)	SRF (MHz) Typ.	DC RESISTANCE (Ω) Max.	Isat ** (A)	Irms *** (A)
SSL0802T-100M-N	10	20	35	0.09	2.40	2.00
SSL0802T-150M-N	15	20	33	0.12	2.00	1.50
SSL0802T-220M-N	22	20	25	0.19	1.60	1.30
SSL0802T-330M-N	33	20	19	0.25	1.40	1.10
SSL0802T-470M-N	47	20	14	0.32	1.00	0.80
SSL0802T-680M-N	68	20	12	0.55	0.90	0.70
SSL0802T-101M-N	100	20	10	0.70	0.70	0.60
SSL0802T-151M-N	150	20	8.0	1.00	0.60	0.50
SSL0802T-221M-N	220	20	6.0	1.60	0.50	0.40
SSL0802T-331M-N	330	20	5.0	2.20	0.40	0.30
SSL0802T-471M-N	470	20	4.0	3.30	0.30	0.20
SSL0802T-681M-N	680	20	3.0	4.40	0.20	0.10
SSL0802T-102M-N	1000	20	2.5	7.00	0.10	0.05

Note:

*Inductance Tested at 100 KHz, 0.1 Vrms.

*** Δ T = 30 °C Rise Typ at Irms.

**Inductance Drop = 20% Typ. at Isat.

Operating Temperature Range: -40 °C to +85 °C



PRODUCT IDENTIFICATION

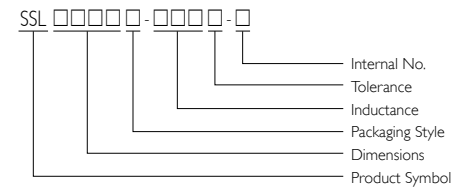

■ Packaging: T = Tape and Reel, B = Bulk

■ Internal No.: N = Lead-Free

SHAPES AND DIMENSIONS

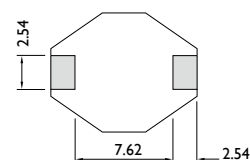
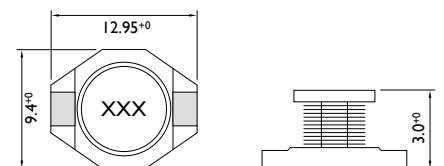

Dimensions: mm

SMD Power Inductors

SSL0804 Series



PRODUCT IDENTIFICATION

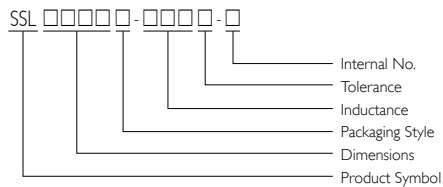

- Packaging: T = Tape and Reel, B = Bulk
- Internal No.: N = Lead-Free

SHAPES AND DIMENSIONS

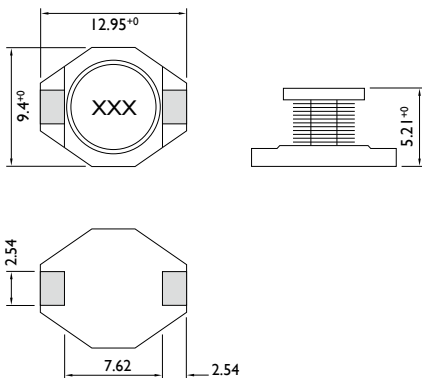

Dimensions: mm

APPLICATIONS

Notebook Computers, Step-up and Step-down Converters

Flash Memory Programmers, etc.

FEATURES

High Energy Storage and Very Low Resistance

Smallest Size and High Performance

ELECTRICAL CHARACTERISTICS

PART NO.	INDUCTANCE * (μ H)	TOLERANCE ($\pm\%$)	SRF (MHz) Typ.	DC RESISTANCE (Ω) Max.	Isat ** (A)	Irms *** (A)
SSL0804T-1R0M-N	1.0	20	100	0.009	9.0	6.8
SSL0804T-1R5M-N	1.5	20	90	0.010	8.0	6.4
SSL0804T-2R2M-N	2.2	20	80	0.012	7.0	6.1
SSL0804T-3R3M-N	3.3	20	65	0.015	6.4	5.4
SSL0804T-4R7M-N	4.7	20	45	0.018	5.4	4.8
SSL0804T-6R8M-N	6.8	20	38	0.027	4.6	4.4
SSL0804T-100M-N	10	20	30	0.038	3.8	3.9
SSL0804T-150M-N	15	20	27	0.046	3.0	3.1
SSL0804T-220M-N	22	20	19	0.085	2.6	2.7
SSL0804T-330M-N	33	20	15	0.100	2.0	2.1
SSL0804T-470M-N	47	20	12	0.140	1.6	1.8
SSL0804T-680M-N	68	20	10	0.200	1.4	1.5
SSL0804T-101M-N	100	20	9.0	0.280	1.2	1.3
SSL0804T-151M-N	150	20	6.0	0.400	1.0	1.0
SSL0804T-221M-N	220	20	5.0	0.610	0.8	0.8
SSL0804T-331M-N	330	20	4.5	1.020	0.6	0.6
SSL0804T-471M-N	470	20	3.5	1.270	0.5	0.5
SSL0804T-681M-N	680	20	2.5	2.020	0.4	0.4
SSL0804T-102M-N	1000	20	2.0	3.000	0.3	0.3

Note:

*Inductance Tested at 100 KHz, 0.1 Vrms.

*** Δ T = 15 °C Rise Typ at Irms.

**Inductance Drop = 20% Typ. at Isat.

Operating Temperature Range: -40 °C to +85 °C

SSL0810 Series

SMD Power Inductors

APPLICATIONS

Notebook Computers, Step-up and Step-down Converters

Flash Memory Programmers, etc.

FEATURES

High Energy Storage and Very Low Resistance

Smallest Size and High Performance

ELECTRICAL CHARACTERISTICS

PART NO.	INDUCTANCE * (μH)	TOLERANCE ($\pm\%$)	SRF (MHz) Typ.	DC RESISTANCE (Ω) Max.	Isat ** (A)	Irms *** (A)
SSL0810T-100M-N	10	20	22	0.033	8.0	3.5
SSL0810T-150M-N	15	20	18	0.042	7.0	3.0
SSL0810T-220M-N	22	20	11	0.054	5.5	2.5
SSL0810T-330M-N	33	20	9.0	0.08	4.0	2.0
SSL0810T-470M-N	47	20	8.0	0.10	3.8	1.6
SSL0810T-680M-N	68	20	7.0	0.17	3.0	1.2
SSL0810T-101M-N	100	20	5.0	0.22	2.5	1.2
SSL0810T-151M-N	150	20	4.0	0.34	2.0	0.9
SSL0810T-221M-N	220	20	3.5	0.44	1.6	0.7
SSL0810T-331M-N	330	20	2.5	0.70	1.2	0.6
SSL0810T-471M-N	470	20	2.0	0.95	1.0	0.3
SSL0810T-681M-N	680	20	2.0	1.20	1.0	0.2
SSL0810T-102M-N	1000	20	1.5	2.00	0.8	0.1

Note:

*Inductance Tested at 100 KHz, 0.1 Vrms.

*** $\Delta T = 40^\circ\text{C}$ Rise Typ at Irms.

**Inductance Drop = 20% Typ. at Isat.

Operating Temperature Range: -40°C to $+85^\circ\text{C}$



PRODUCT IDENTIFICATION

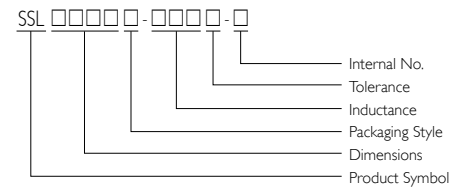

■ Packaging: T = Tape and Reel, B = Bulk

■ Internal No.: N = Lead-Free

SHAPES AND DIMENSIONS

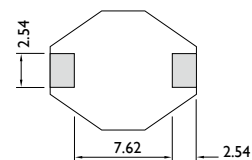
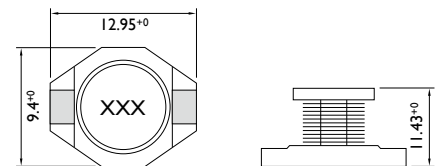

Dimensions: mm

SMD Power Inductors

SSL I 306 Series



PRODUCT IDENTIFICATION

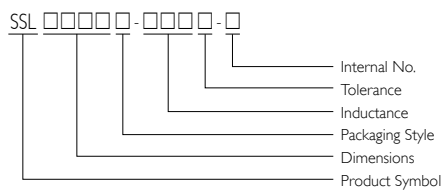

- Packaging: T = Tape and Reel, B = Bulk
- Internal No.: N = Lead-Free

SHAPES AND DIMENSIONS

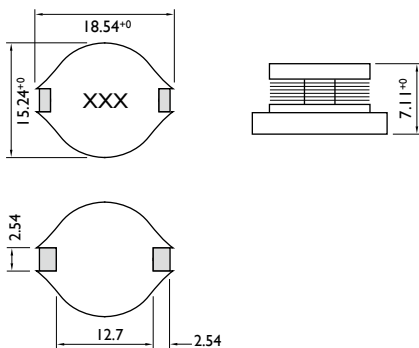

Dimensions: mm

APPLICATIONS

Notebook Computers, Step-up and Step-down Converters

Flash Memory Programmers, etc.

FEATURES

High Energy Storage and Very Low Resistance

Smallest Size and High Performance

ELECTRICAL CHARACTERISTICS

PART NO.	INDUCTANCE * (μ H)	TOLERANCE ($\pm\%$)	SRF (MHz) Typ.	DC RESISTANCE (Ω) Max.	Isat ** (A)	I _{rms} *** (A)
SSL I 306T-1R0M-N	1.0	20	80	0.011	20	8.6
SSL I 306T-2R2M-N	2.2	20	80	0.014	16	7.1
SSL I 306T-3R3M-N	3.3	20	60	0.016	14	6.2
SSL I 306T-5R6M-N	5.6	20	40	0.022	12	5.3
SSL I 306T-100M-N	10	20	30	0.032	10	4.3
SSL I 306T-150M-N	15	20	22	0.036	8.0	4.0
SSL I 306T-220M-N	22	20	20	0.047	7.0	3.5
SSL I 306T-330M-N	33	20	15	0.066	5.5	3.0
SSL I 306T-470M-N	47	20	9.0	0.087	4.5	2.6
SSL I 306T-680M-N	68	20	8.0	0.13	3.5	2.3
SSL I 306T-101M-N	100	20	7.0	0.19	3.0	1.8
SSL I 306T-151M-N	150	20	6.0	0.25	2.6	1.5
SSL I 306T-221M-N	220	20	5.0	0.38	2.4	1.2
SSL I 306T-331M-N	330	20	4.0	0.56	1.9	1.0
SSL I 306T-471M-N	470	20	3.0	0.85	1.4	0.82
SSL I 306T-681M-N	680	20	2.5	1.20	1.2	0.72
SSL I 306T-102M-N	1000	20	2.0	1.80	1.0	0.56

Note:

*Inductance Tested at 100 KHz, 0.1 Vrms.

*** $\Delta T = 40$ °C Rise Typ at I_{rms}.

**Inductance Drop = 20% Typ. at Isat.

Operating Temperature Range: -40 °C to +85 °C

TAPE DIMENSIONS

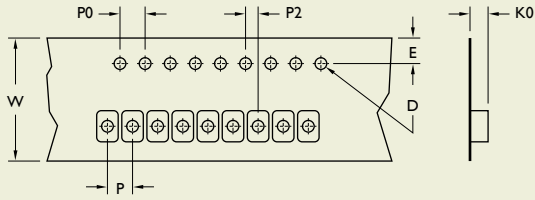

TAPE MATERIAL

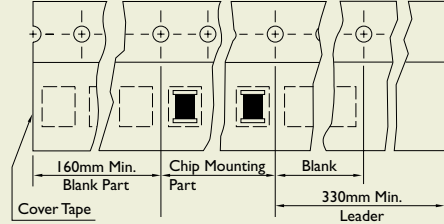

REEL DIMENSIONS

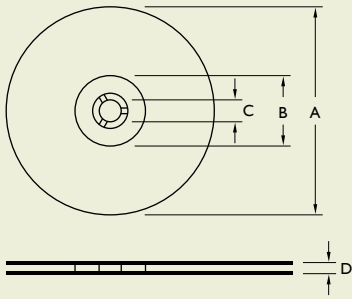

RECOMMENDED PATTERN

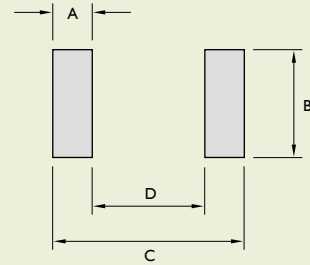

Dimensions: mm

TYPE	TAPE DIMENSIONS							RECOMMENDED PATTERN				REEL DIMENSIONS				QUANTITY/ REEL	
	K0	D	E	W	P	P0	P2	A	B	C	D	A	B	C	D	178	330
SSL04LP	1.30	1.50	1.75	12	8	4	2	1.40	3.56	6.86	4.06	330	100	13	13.4	-	3,500
												178	60		13.2	1,000	-
SSL0400	1.85	1.50	1.75	12	8	4	2	1.40	3.56	6.86	4.06	330	100	13	13.4	-	3,500
												178	60		13.2	1,000	-
SSL0402	3.20	1.55	1.75	12	8	4	2	1.40	3.56	6.86	4.06	330	100	13	13.4	-	2,500
												178	60		13.2	750	-
SSL0614	1.80	1.50	1.75	16	12	4	2	1.21	5.84	9.66	7.24	330	100	13	17.4	-	2,500
SSL0802	3.75	1.55	1.75	24	16	4	2	2.92	2.79	13.21	7.34	330	100	13	24.4	-	1,000
SSL0804	5.40	1.55	1.75	24	16	4	2	2.92	2.79	13.21	7.34	330	100	13	24.4	-	750
SSL0810	11.5	1.55	1.75	24	20	4	2	2.92	2.79	13.21	7.34	330	100	13	24.4	-	225
SSL1306	7.50	1.55	1.75	32	20	4	2	2.92	2.79	18.29	12.45	330	100	13	33.4	-	250

SMD Power Inductors

SSL0503HC Series



PRODUCT IDENTIFICATION

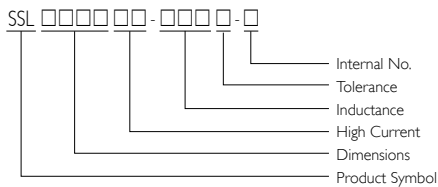

- Packaging: T = Tape and Reel, B = Bulk
- Internal No.: N = Lead-Free

SHAPES AND DIMENSIONS

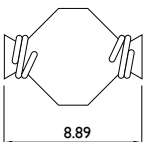
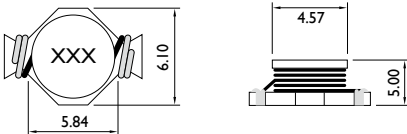

Dimensions: mm

APPLICATIONS

Notebook Computers, Step-up and Step-down Converters

Memory Programmers, etc.

OUTLINE

This series is specially designed for high current, low voltage DC-DC converter applications.

Its simple, rugged design provides current ratings normally available in larger packages. With its tinned self-leaded construction, SSL-HC series can achieve very low DCR values and excellent solderability. In addition, they have very low resistance and a rugged self-leaded construction. Standard parts shown in catalogue and custom values are also available.

FEATURES

For High Current, Low Voltage DC-DC Converter Applications.

ELECTRICAL CHARACTERISTICS

PART NO.	INDUCTANCE * (μ H)	TOLERANCE (\pm %)	SRF ** (MHz) Typ.	DC RESISTANCE (Ω) Max.	Isat *** (A)	Irms **** (A)
SSL0503HC-R56M-N	0.56	20	200	0.010	7.70	6.00
SSL0503HC-1R2M-N	1.20	20	140	0.017	5.30	4.40
SSL0503HC-2R2M-N	2.20	20	100	0.035	3.50	3.10
SSL0503HC-4R7M-N	4.70	20	50	0.054	2.60	2.20
SSL0503HC-100M-N	10	20	40	0.111	1.90	1.50
SSL0503HC-150M-N	15	20	30	0.170	1.50	1.20
SSL0503HC-220M-N	22	20	25	0.250	1.20	1.00
SSL0503HC-330M-N	33	20	20	0.370	0.99	0.82
SSL0503HC-470M-N	47	20	15	0.470	0.87	0.72

Note:

*Inductance Tested at 100 KHz, 0.25 Vrms.

**SRF measured using HP8753D network analyzer.

***Inductance Drop = 30% Typ. at Isat.

**** $\Delta T = 40$ °C Rise Typ at I_{rms}.

Operating Temperature Range: -40 °C to +85 °C Electrical specifications at 25 °C

SSL0804HC Series

SMD Power Inductors

APPLICATIONS

Notebook Computers, Step-up and Step-down Converters

Memory Programmers, etc.

OUTLINE

This series is specially designed for high current, low voltage DC-DC converter applications.

Its simple, rugged design provides current ratings normally available in larger packages. With its tinned self-leaded construction, SSL-HC series can achieve very low DCR values and excellent solderability. In addition, they have very low resistance and a rugged self-leaded construction. Standard parts shown in catalogue and custom values are also available.

FEATURES

For high current, low voltage DC-DC converter applications.

ELECTRICAL CHARACTERISTICS

PART NO.	INDUCTANCE * (μ H)	TOLERANCE (\pm %)	SRF ** (MHz) Typ.	DC RESISTANCE (Ω) Max.	Isat *** (A)	Irms **** (A)
SSL0804HC-R33M-N	0.33	20	300	0.002	20.0	16.0
SSL0804HC-R68M-N	0.68	20	200	0.005	13.0	12.0
SSL0804HC-1R0M-N	1.00	20	100	0.006	11.0	10.0
SSL0804HC-1R5M-N	1.50	20	90	0.008	9.00	9.00
SSL0804HC-2R2M-N	2.20	20	90	0.011	7.80	7.40
SSL0804HC-2R7M-N	2.70	20	65	0.012	7.00	6.60
SSL0804HC-3R3M-N	3.30	20	65	0.014	6.40	5.90
SSL0804HC-4R7M-N	4.70	20	45	0.018	5.40	4.80
SSL0804HC-6R8M-N	6.80	20	35	0.035	3.60	5.00
SSL0804HC-100M-N	10	20	26	0.04	3.30	4.30
SSL0804HC-150M-N	15	20	21	0.06	2.40	3.50
SSL0804HC-220M-N	22	20	17	0.08	2.00	2.80
SSL0804HC-330M-N	33	20	14	0.15	1.70	2.10
SSL0804HC-470M-N	47	20	12	0.28	1.40	1.70
SSL0804HC-680M-N	68	20	9	0.30	1.20	1.50
SSL0804HC-101M-N	100	20	7	0.40	0.95	1.20

Note:

*Inductance Tested at 100 KHz, 0.1 Vrms.

**SRF measured using HP8753D network analyzer.

***Inductance Drop = 10% Typ. at Isat.

**** $\Delta T = 40^\circ\text{C}$ Rise Typ at I rms.

Operating Temperature Range: -40°C to $+85^\circ\text{C}$ Electrical specifications at 25°C



PRODUCT IDENTIFICATION

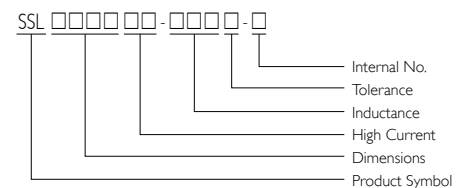

■ Packaging: T = Tape and Reel, B = Bulk

■ Internal No.: N = Lead-Free

SHAPES AND DIMENSIONS

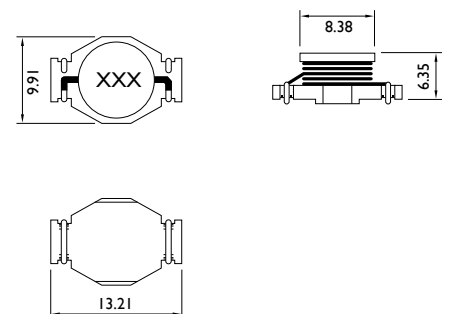

Dimensions: mm

SMD Power Inductors

SSL I 306HC Series



PRODUCT IDENTIFICATION

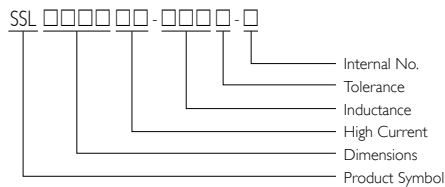

- Packaging: T = Tape and Reel, B = Bulk
- Internal No.: N = Lead-Free

SHAPES AND DIMENSIONS

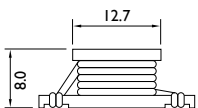
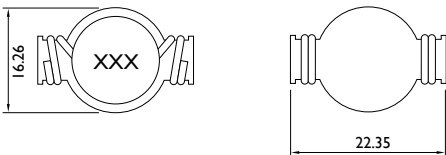

Dimensions: mm

APPLICATIONS

Notebook Computers, Step-up and Step-down Converters

Memory Programmers, etc.

OUTLINE

This series is specially designed for high current, low voltage DC-DC converter applications.

Its simple, rugged design provides current ratings normally available in larger packages. With its tinned self-leaded construction, SSL-HC series can achieve very low DCR values and excellent solderability. In addition, they have very low resistance and a rugged self-leaded construction. Standard parts shown in catalogue and custom values are also available.

FEATURES

For high current, low voltage DC-DC converter applications.

ELECTRICAL CHARACTERISTICS

PART NO.	INDUCTANCE * (μH)	TOLERANCE ($\pm\%$)	SRF (MHz) Typ.	DC RESISTANCE (Ω) Max.	Isat ** (A)	Irms *** (A)
SSLI 306HC-R78M-N	0.78	20	156	2.6	30	15
SSLI 306HC-1R5M-N	1.50	20	100	4.0	25	15
SSLI 306HC-2R2M-N	2.20	20	75	6.1	20	12
SSLI 306HC-3R3M-N	3.30	20	60	8.6	17	10
SSLI 306HC-3R9M-N	3.90	20	55	10	15	9.0
SSLI 306HC-4R7M-N	4.70	20	40	14	13	8.4
SSLI 306HC-6R0M-N	6.00	20	35	17	12	7.5
SSLI 306HC-7R8M-N	7.80	20	35	18	11	7.5
SSLI 306HC-100M-N	10	20	28	26	10	6.0
SSLI 306HC-150M-N	15	20	20	32	8.0	4.4

Note:

*Inductance Tested at 100 KHz, 0.25 Vrms.

*** $\Delta T = 40^\circ\text{C}$ Rise Typ at I_{rms}.

**Inductance Drop = 30% Typ. at Isat.

Operating Temperature Range: -40°C to $+85^\circ\text{C}$

TAPE DIMENSIONS

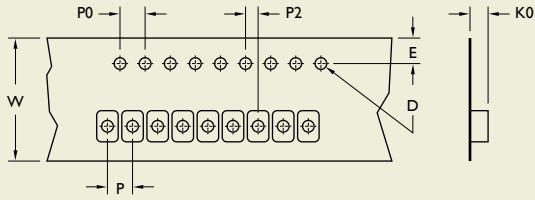

TAPE MATERIAL

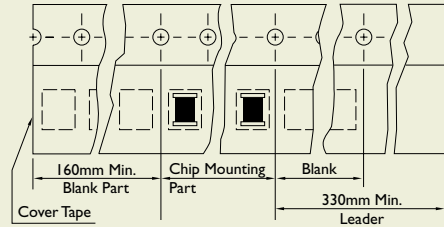

REEL DIMENSIONS

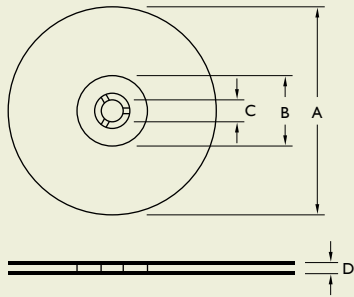

RECOMMENDED PATTERN

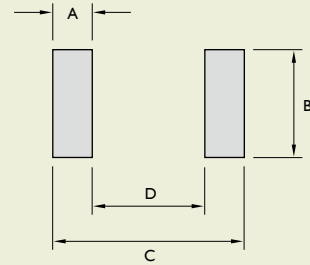

Dimensions: mm

TYPE	TAPE DIMENSIONS							RECOMMENDED PATTERN				REEL DIMENSIONS				QUANTITY/ REEL
	K0	D	E	W	P	P0	P2	A	B	C	D	A	B	C	D	
SSL0503HC	5.30	1.55	1.75	16	12	4	2	1.91	4.06	8.89	5.08	330	100	13	17.4	1,000
SSL0804HC	6.10	1.55	1.75	24	16	4	2	1.52	4.06	11.68	8.64	330	100	13	24.2	700
SSL1306HC	7.20	1.55	1.75	44	24	4	2	3.18	8.64	20.71	14.35	330	100	13	45.4	250

SMD Power Inductors

SCD Series



PRODUCT IDENTIFICATION

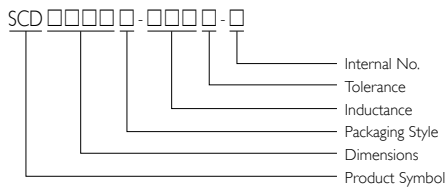

- Packaging: T = Tape and Reel
- Internal No.: N = Lead-Free

APPLICATIONS

Power Supply for VTRs

OA Equipment

LCD Televisions

Notebook PCs

Portable Communication Equipment

DC-DC Converters, etc.

OUTLINE

Various high power surface mountable type inductors are superior to high saturation. These are also magnetic shielded type for consideration against radiation.

FEATURES

High saturation for surface mounting

Available in magnetically shielded.

Suitable for large currents.

Ideal for a variety of DC-DC converter inductor applications.

Available on tape and reel for auto surface mounting.



ELECTRICAL CHARACTERISTICS DC RESISTANCE

STAMP	INDUCTANCE (μ H)	DC RESISTANCE (Ω) Max.															
		SCD 0301	SCD 03011	SCD 03015	SCD 03021	SCD 0403	SCD 0501	SCD 0502	SCD 0503	SCD 0504	SCD 0506	SCD 0703	SCD 0705	SCD 0706	SCD 1004	SCD 1005	SCD 1006
1R0	1.0		0.084		0.07	0.033	0.034	0.03	0.03								
1R2	1.2								0.03								
1R4	1.4				0.09	0.038	0.048	0.04					0.02				
1R5	1.5		0.126						0.03								
1R8	1.8				0.11	0.042	0.062	0.05	0.03				0.02				
2R2	2.2	0.33	0.18	0.10 \pm 30%	0.13	0.047	0.064	0.06	0.03								
2R7	2.7				0.14	0.052	0.078	0.07	0.04				0.02				
3R3	3.3	0.52	0.27		0.17	0.058	0.097	0.08	0.05								
3R9	3.9		0.32		0.19	0.076	0.105	0.09	0.06				0.03				
4R7	4.7	0.62	0.33	0.15 \pm 30%	0.21	0.094	0.134	0.14	0.07				0.04			0.04	
5R6	5.6		0.48		0.22	0.101	0.170	0.15	0.08				0.04				
6R8	6.8	0.87	0.56		0.25	0.117	0.187	0.16	0.09				0.04			0.037	
8R2	8.2	1.00	0.62		0.28	0.132	0.225	0.17	0.10				0.05				
100	10	1.14	0.90	0.30 \pm 30%	0.32	0.182	0.255	0.18	0.12	0.10		0.08	0.07		0.05	0.06	
120	12	1.44	1.00		0.35	0.210	0.292	0.20	0.13	0.12		0.09	0.08		0.06	0.07	
150	15	1.60	1.10	0.58 \pm 30%	0.40	0.235	0.360	0.22	0.15	0.14		0.10	0.09	0.08	0.07	0.08	
180	18		1.24		0.48	0.338	0.430	0.25	0.22	0.15		0.11	0.10		0.08	0.09	
220	22	1.90	1.40	0.71 \pm 30%	0.58	0.378	0.492	0.35	0.22	0.18	0.165	0.13	0.11		0.09	0.10	
270	27	2.85	2.18		0.65	0.522	0.603	0.45	0.26	0.20		0.15	0.12		0.10	0.11	
330	33		2.54	1.10 \pm 30%	0.80	0.540	0.796	0.56	0.33	0.23		0.17	0.13	0.14	0.12	0.12	
390	39		2.80		0.90	0.587	0.897	0.69	0.42	0.32		0.22	0.16		0.15	0.14	
470	47		3.10	1.30 \pm 30%	1.19	0.844	1.020	0.72	0.50	0.37		0.25	0.18		0.17	0.17	
500	50		3.20		1.22		1.040										
560	56		3.50		1.27	0.937	1.164	0.84	0.55	0.42		0.28	0.24		0.20	0.19	
680	68		5.80	2.20 \pm 30%	1.73	1.117	1.220	0.90	0.65	0.46		0.33	0.28		0.22	0.22	
750	75		6.10		1.90		1.340										
820	82		6.60		1.99		1.570	1.20	0.80	0.60		0.41	0.37		0.30	0.25	
101	100			3.50 \pm 30%	2.52	2.000	1.80	1.30	0.90	0.70		0.48	0.43		0.34	0.35	
121	120				2.90		2.00	1.38	1.00	0.93		0.54	0.47		0.40	0.40	
151	150				3.36		2.80	1.81	1.30	1.10		0.75	0.64		0.54	0.47	
181	180				5.10		3.15	1.95	1.50	1.38		1.02	0.71		0.62	0.63	
221	220				5.80		4.40	3.00	2.00	1.57		1.20	0.96		0.72	0.73	
271	270				7.80		6.40	3.20	2.50	1.85		1.31	1.11		0.95	0.97	
301	300				8.10		6.75										
331	330				9.24		7.20	3.82	3.20	2.00		1.50	1.26		1.10	1.15	
391	390				10.14		8.40	4.68	3.50	2.60			1.77		1.24	1.30	
461	460				11.15		12.0										
471	470				11.48		12.4	5.10	4.20	3.00			1.96		1.53	1.48	
561	560				19.49		13.0	8.50	4.50	4.19					1.90	1.90	
681	680				22.00		17.0	10.0	6.50	4.44						2.25	
821	820				23.98		19.5	12.0	7.50	5.12						2.55	
102	1,000				28.80		24.0	18.0	8.00	10.0							
122	1,200																
152	1,500				38 \pm 30%												
602	6,000				55 \pm 30%												
822	8,200																14 50

Note:

Test Freq.(L): SCD0301: 0.1V/100KHz; SCD03011: (100KHz/1V), SCD03015: (1MHz/1V)

SCD03021/0403/0501/0502/ 0503: 1.0 to 8.2 μ H (7.96MHz/1V), 10 to 82 μ H (2.52MHz/1V), 100 to 1,000 μ H (1KHz/1V).

SCD0504/0506/0703/0705/0706/1004: 1.0 to 8.2 μ H (7.96MHz/1V), 10 to 82 μ H (2.52MHz/1V), 100 to 1,000 μ H (1KHz/1V).

SCD1005/1006: 1.0 to 8.2 μ H (7.96MHz/1V), 10 to 82 μ H (2.52MHz/1V), 100 to 1,000 μ H (1KHz/1V).

Test Instrument: L- HP 4192A, RDC- CH502BC, Rated D.C. Current- HP4284+42841A or CH1061+CH301A

ELECTRICAL CHARACTERISTICS PERMISSIBLE D.C. CURRENT (A)

STAMP	INDUCTANCE (µH)	DC RESISTANCE (Ω) Max.															
		SCD 0301	SCD 03011	SCD 03015	SCD 03021	SCD 0403	SCD 0501	SCD 0502	SCD 0503	SCD 0504	SCD 0506	SCD 0703	SCD 0705	SCD 0706	SCD 1004	SCD 1005	SCD 1006
IR0	1.0		1.80		2.080	3.80	4.00	4.50	4.50								
IR2	1.2								4.20								
IR4	1.4				1.860	3.30	3.60	4.00					3.70				
IR5	1.5		1.44						4.10								
IR8	1.8				1.800	2.91	3.00	3.30	3.70				3.70				
2R2	2.2	1.08	1.26	0.79	1.390	2.60	2.65	2.94	3.50								
2R7	2.7				1.320	2.43	2.20	2.50	3.20				3.70				
3R3	3.3	0.92	1.08		1.250	2.15	2.11	2.35	2.80								
3R9	3.9		1.00		1.200	1.98	2.00	2.20	2.60				3.70				
4R7	4.7	0.74	0.90	0.65	1.130	1.70	1.80	2.00	2.50				3.50			2.60	
5R6	5.6		0.76		0.910	1.60	1.60	1.80	2.40				3.30				
6R8	6.8	0.63	0.68		0.850	1.41	1.50	1.70	2.20				3.10			4.33	
8R2	8.2	0.58	0.63		0.820	1.26	1.30	1.40	2.00				2.70				
100	10	0.50	0.56	0.45	0.740	1.15	1.10	1.20	1.80	1.44		1.44	2.30		2.38	2.60	
120	12	0.46	0.52		0.640	1.05	1.05	1.18	1.75	1.40		1.39	2.00		2.13	2.45	
150	15	0.43	0.50	0.30	0.600	0.92	1.00	1.15	1.70	1.30		1.24	1.80	2.80	1.87	2.27	
180	18		0.46		0.540	0.84	0.95	1.10	1.60	1.23		1.12	1.60		1.73	2.15	
220	22	0.35	0.36	0.25	0.500	0.76	0.90	1.00	1.50	1.11	1.60	1.07	1.50		1.60	1.95	
270	27	0.32	0.30		0.430	0.71	0.77	0.86	1.40	0.97		0.94	1.30		1.44	1.76	
330	33		0.28	0.20	0.400	0.64	0.68	0.76	1.10	0.88		0.85	1.20	2.30	1.26	1.50	
390	39		0.26		0.370	0.59	0.67	0.75	1.00	0.80		0.74	1.10		1.20	1.37	
470	47		0.25	0.17	0.360	0.54	0.66	0.73	0.90	0.72		0.68	1.10		1.10	1.28	
500	50		0.24		0.330		0.61										
560	56		0.23		0.310	0.50	0.50	0.55	0.85	0.68		0.64	0.94		1.01	1.17	
680	68		0.20	0.13	0.300	0.46	0.47	0.52	0.80	0.61		0.59	0.85		0.91	1.11	
750	75		0.18		0.290		0.46										
820	82		0.17		0.280		0.45	0.50	0.65	0.58		0.54	0.78		0.85	1.00	
101	100			0.10	0.250	0.40	0.36	0.40	0.60	0.52		0.51	0.72		0.74	0.97	
121	120				0.200		0.32	0.36	0.58	0.48		0.49	0.66		0.69	0.89	
151	150				0.190		0.27	0.30	0.43	0.40		0.40	0.58		0.61	0.78	
181	180				0.170		0.23	0.26	0.41	0.38		0.36	0.51		0.56	0.72	
221	220				0.160		0.22	0.25	0.38	0.35		0.31	0.49		0.53	0.66	
271	270				0.140		0.19	0.21	0.35	0.29		0.29	0.42		0.45	0.57	
301	300				0.135		0.18										
331	330				0.130		0.16	0.18	0.28	0.28		0.28	0.40		0.42	0.52	
391	390				0.120		0.15	0.16	0.26	0.26			0.36		0.38	0.48	
461	460				0.090		0.14										
471	470				0.084		0.14	0.15	0.20	0.12			0.34		0.35	0.42	
561	560				0.080		0.13	0.14	0.19	0.10					0.32	0.33	
681	680				0.080		0.12	0.13	0.18	0.08						0.28	
821	820				0.070		0.063	0.07	0.15	0.05						0.24	
102	1,000				0.060		0.045	0.05	0.13	0.03							
122	1,200			0.05													
152	1,500			0.03													
602	6,000																0.27
822	8,200																0.20

Tolerance of Inductance: SCD0301: 2.2 to 27 µH ± 20%; SCD03011: 1.0 to 82 µH ± 20%; SCD03015: 2.2 to 1,500 µH ± 20%; SCD03021: 1.0 to 1,000 µH ± 20%
 SCD0403: 1.0 to 27 µH ± 20%, 33 to 100 µH ± 10%; SCD0501: 1.0 to 27 µH ± 20%, 33 to 1,000 µH ± 10%
 SCD0502: 1.0 to 27 µH ± 20%, 33 to 1,000 µH ± 10%; SCD0503: 1.0 to 27 µH ± 20%, 33 to 1,000 µH ± 10%
 SCD0504: 1.0 to 27 µH ± 20%, 33 to 47 µH ± 15%, 56 to 1,000 µH ± 10%; SCD0506: 22 µH ± 20%
 SCD0703: 10 to 27 µH ± 20%, 33 to 330 µH ± 10%; SCD0705: 1.4 to 27 µH ± 20%, 33 to 470 µH ± 10%
 SCD0706: 15 µH ± 20%, 33 µH ± 10%; SCD1004: 10 to 27 µH ± 20%, 33 to 560 µH ± 10%; SCD1005: 4.7 to 27 µH ± 20%, 33 to 820 µH ± 10%
 SCD1006: 4.7 to 27 µH ± 20%, 33 to 820 µH ± 10%; SCD1006: 6,000 to 8,200 µH ± 20%

Tolerance: K = ± 10%, M = ± 20%

This indicates the value of current when the inductance is 10% lower than its initial value at D.C superposition or D.C current when at ΔT = 40 °C whichever is lower



TAPE DIMENSIONS

Figure 1

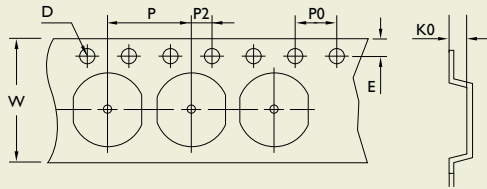
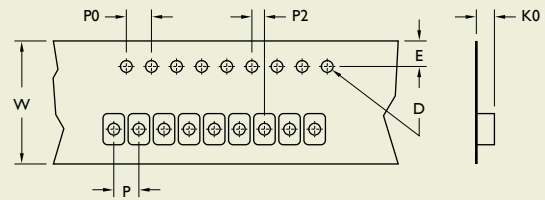
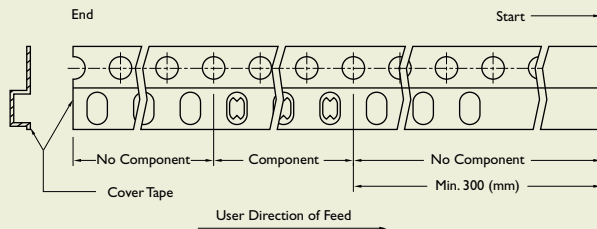

Figure 2



TAPE MATERIAL



REEL DIMENSIONS

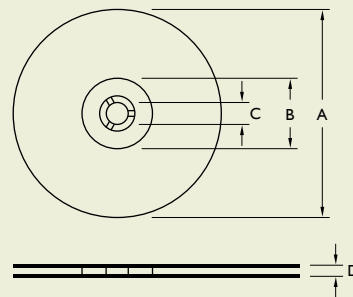

Dimensions: mm

TYPE	FIGURE	TAPE DIMENSIONS							REEL DIMENSIONS				QUANTITY/ REEL
		K0	D	E	W	P	P0	P2	A	B	C	D	
SCD0301	2	1.40	1.55	1.75	12	8	4	2	178	60	13	13.2	1,000
SCD03011	1	1.40	1.50	1.75	12	8	4	2	330	100	13	13.4	3,000
SCD03015	1	1.80	1.55	1.75	12	8	4	2	330	100	13	13.4	3,000
SCD03021	1	2.50	1.55	1.75	12	8	4	2	330	100	13	13.4	3,000
SCD0403	1	3.55	1.55	1.75	12	8	4	2	330	100	13	13.4	2,000
SCD0501	1	2.35	1.55	1.75	12	8	4	2	330	100	13	13.4	2,000
SCD0502	1	3.30	1.50	1.75	16	8	4	2	330	100	13	17.4	2,000
SCD0503	1	3.30	1.50	1.75	16	8	4	2	330	100	13	17.4	2,000
SCD0504	1	4.80	1.55	1.75	16	8	4	2	330	100	13	17.4	1,500
SCD0506	1	6.40	1.55	1.75	16	8	4	2	330	100	13	17.4	1,500
SCD0703	1	3.80	1.55	1.75	16	12	4	2	330	100	13	17.4	1,000
SCD0705	1	5.20	1.55	1.75	16	12	4	2	330	100	13	17.4	700
SCD0706	1	6.40	1.55	1.75	16	12	4	2	330	100	13	17.4	700
SCD1004	1	4.50	1.55	1.75	24	12	4	2	330	100	13	24.4	700
SCD1005	1	5.80	1.55	1.75	24	12	4	2	330	100	13	24.4	700
SCD1006	1	7.00	1.55	1.75	24	12	4	2	330	100	13	24.4	700



ELECTRICAL CHARACTERISTICS

STAMP	INDUCTANCE (μ H)	DC RESISTANCE (Ω) Max.							RATED CURRENT (A)						
		SCDS 62T	SCDS 64T	SCDS 73	SCDS 74	SCDS 124	SCDS 125	SCDS 127	SCDS 62T	SCDS 64T	SCDS 73	SCDS 74	SCDS 124	SCDS 125	SCDS 127
1R2	1.2							7.0							9.80
2R4	2.4							11.5							8.00
3R3	3.3	68							1.94						
3R5	3.5							13.5							7.50
3R9	3.9					15							6.50		
4R7	4.7	80				18		15.8	1.63				5.70	6.80	
5R5	5.5	96							1.40						
6R1	6.1							17.6							6.60
6R8	6.8	100				23			1.33				4.90		
7R6	7.6							20.0							5.90
8R2	8.2	100							1.14						
120	12	200	130	98	58	38	27	24.3	1.00	1.22	1.52	1.71	4.00	3.50	4.90
150	15	230	180	130	81	50	30	27.0	0.90	1.11	1.33	1.47	3.20	3.30	4.50
180	18	270	240	140	91	57	34	39.2	0.80	1.02	1.20	1.31	3.10	3.00	3.90
220	22	340	270	190	110	66	36	43.2	0.74	0.91	1.07	1.23	2.90	2.80	3.60
270	27	380	300	210	150	80	51	45.9	0.66	0.82	0.96	1.12	2.80	2.30	3.40
330	33	450	330	240	170	97	57	64.8	0.59	0.74	0.91	0.96	2.70	2.10	3.00
390	39	490	370	320	230	132	68	72.9	0.54	0.69	0.77	0.91	2.10	2.00	2.75
470	47	690	520	360	260	150	75	100	0.50	0.62	0.76	0.88	1.90	1.80	2.50
560	56	780	560	470	350	190	110	110	0.46	0.58	0.68	0.75	1.80	1.70	2.35
680	68	1,070	630	520	380	220	120	140	0.42	0.51	0.61	0.69	1.50	1.50	2.10
820	82	1,210	710	690	430	260	140	160	0.38	0.46	0.57	0.61	1.30	1.40	1.95
101	100	1,390	1,030	790	610	308	160	220	0.34	0.42	0.50	0.60	1.20	1.30	1.70
121	120	1,900	1,150	890	660	380	170	250	0.31	0.38	0.49	0.52	1.10	1.10	1.60
151	150	2,180	1,680	1,270	880	530	230	280	0.28	0.35	0.43	0.46	0.95	1.00	1.42
181	180	2,770	1,870	1,450	980	620	290	350	0.26	0.32	0.39	0.42	0.85	0.90	1.30
221	220	3,120	2,080	1,650	1,170	700	400	390	0.23	0.29	0.35	0.36	0.80	0.80	1.16
271	270	4,380	2,370	2,310	1,640	876	460	560	0.22	0.26	0.32	0.34	0.60	0.75	1.06
331	330	4,940	2,670	2,620	1,860	990	510	640	0.19	0.23	0.28	0.32	0.50	0.68	0.95
391	390		2,940	2,940	2,850		690	700		0.22	0.26	0.29		0.65	0.88

ELECTRICAL CHARACTERISTICS

STAMP	INDUCTANCE (μH)	DC RESISTANCE (Ω) Max.							RATED CURRENT (A)						
		SCDS 62T	SCDS 64T	SCDS 73	SCDS 74	SCDS 124	SCDS 125	SCDS 127	SCDS 62T	SCDS 64T	SCDS 73	SCDS 74	SCDS 124	SCDS 125	SCDS 127
471	470		3,930	4,180	3,010		770	980		0.20	0.24	0.26		0.58	0.79
561	560		5,430	4,670	3,620		860	1,070		0.18	0.22	0.23		0.54	0.73
681	680		7,320	5,730	4,630		1,200	1,460		0.17	0.19	0.22		0.48	0.67
821	820		8,240	6,540	5,200		1,340	1,640		0.15	0.18	0.20		0.43	0.60
102	1,000		9,260	9,440	6,000		1,530	1,820		0.14	0.16	0.18		0.40	0.55

Note:

Test Freq.(L): SCDS62T: 3.3 to 8.2 μH (7.96MHz/1V), 10 to 82 μH (2.52MHz/1V), 100 to 330 μH (1KHz/1V)

SCDS64T/73/74/125: (1KHz/1V); SCDS124: (100KHz/1V); SCDS127: 1.2 to 7.6 μH (100KHz/1V), 10 to 1,000 μH (1KHz/1V)

Test Instrument: L- HP 4192A LF Impedance analyzer; RDC- CH502BC, Rated Current- HP4284+42841A or CH1061+CH301A

Rated current: The rated current indicates the current when the inductance decrease to 65%. Over of it's nominal value or D.C. current when the temperature rising $\Delta T = 40^\circ\text{C}$ lower, whichever is lower.

Tolerance: M = $\pm 20\%$, T = $\pm 30\%$, N = +40% / -20%

TOLERANCE OF INDUCTORS

SCDS62T	3.3 to 330 $\mu\text{H} \pm 20\%$	SCDS124	3.9 to 330 $\mu\text{H} \pm 20\%$
SCDS64T	10 to 1,000 $\mu\text{H} \pm 20\%$	SCDS125	10 to 1,000 $\mu\text{H} \pm 20\%$
SCDS73	10 to 1,000 $\mu\text{H} \pm 20\%$	SCDS127	1.2 to 7.6 $\mu\text{H} +40\% / -20\%$
SCDS74	10 to 1,000 $\mu\text{H} \pm 20\%$		10 to 1,000 $\mu\text{H} \pm 20\%$



TAPE DIMENSIONS

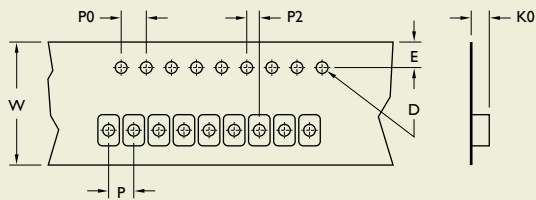

TAPE MATERIAL

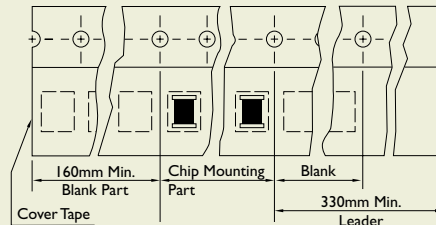

REEL DIMENSIONS

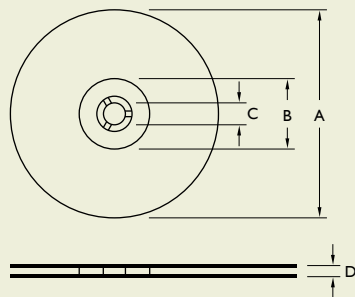

RECOMMENDED PATTERN

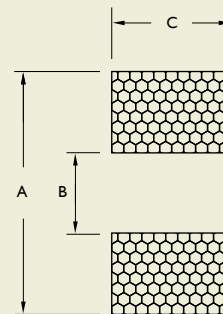

Dimensions: mm

TYPE	TAPE DIMENSIONS							RECOMMENDED PATTERN			REEL DIMENSIONS				QUANTITY/ REEL
	K0	D	E	W	P	P0	P2	A	B	C	A	B	C	D	
SCDS62	3.40	1.55	1.75	16	12	4	2	8.1	4.0	2.5	330	100	13	17.4	1,500
SCDS64	4.90	1.55	1.75	16	12	4	2	8.1	4.0	2.5	330	100	13	17.4	1,000
SCDS73	3.60	1.55	1.75	16	12	4	2	8.4	4.4	2.2	330	100	13	17.4	1,600
SCDS74	5.00	1.55	1.75	16	12	4	2	8.4	4.4	2.2	330	100	13	17.4	1,000
SCDS124	5.10	1.55	1.75	24	16	4	2	13.0	7.0	5.4	330	100	13	24.4	500
SCDS125	6.70	1.55	1.75	24	16	4	2	13.0	7.0	5.4	330	100	13	24.4	600
SCDS127	8.70	1.55	1.75	24	16	4	2	13.0	7.0	5.4	330	100	13	24.4	500

SCDS Series

SMD Power Inductors

APPLICATIONS

- Power Supply for VTRs
- OA Equipment
- LCD Televisions
- Notebook PCs
- Portable Communication Equipment
- DC-DC Converters, etc.

FEATURES

- Available in magnetically shielded
- Low DC resistance
- Suitable for large currents
- Ideal for a variety of DC-DC converter inductor applications.
- Available on tape and reel for auto surface mounting.

SHAPES AND DIMENSIONS

TYPE	A	B	C	D	E	F	G
SCDS104R	10.3 ⁺⁰	10.5 ⁺⁰	4 ⁺⁰	1.2	3.0	7.7	13.5 ⁺⁰
SCDS105R	10.3 ⁺⁰	10.5 ⁺⁰	5.1 ⁺⁰	1.2	3.0	7.7	13.5 ⁺⁰



PRODUCT IDENTIFICATION

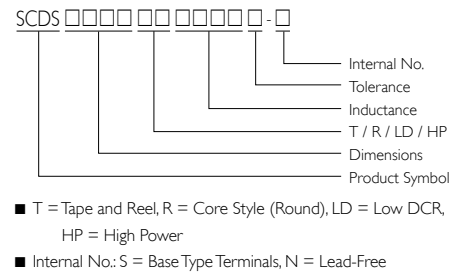

Unit: mm

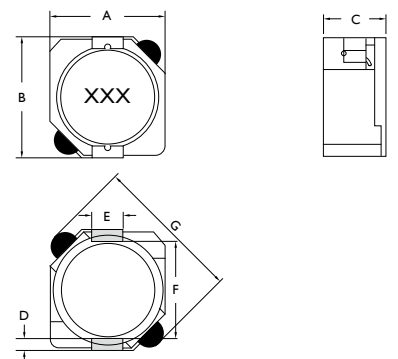



ELECTRICAL CHARACTERISTICS

STAMP	INDUCTANCE (μH)	DC RESISTANCE (Ω) Max.		RATED CURRENT (A)	
		SCDS104R	SCDS105R	SCDS104R	SCDS105R
R80	0.8		4.3		13.50
1R5	1.5	8.1	5.8	10.00	10.50
2R2	2.2		7.2		9.25
2R5	2.5	10.5		7.50	
3R3	3.3		10.4		7.80
3R8	3.8	13		6.00	
4R7	4.7		12.3		6.40
5R2	5.2	22		5.50	
6R8	6.8		18		5.40
7R0	7.0	27		4.80	
8R2	8.2		20		4.85
100	10	35	26	4.40	4.45
120	12		33		4.00
150	15	50	41	3.60	3.60
180	18		46		3.20
220	22	73	61	2.90	2.95
270	27		69		2.70
330	33	93	84	2.30	2.50
390	39		106		2.30
470	47	128	130	2.10	2.00
560	56		149		1.90
680	68	213	201	1.50	1.65
820	82		227		1.50
101	100	304	253	1.35	1.35
121	120		303		1.28
151	150	506	370	1.15	1.12
181	180		419		1.04
221	220	756	500	0.92	0.94
271	270		672		0.84
331	330	1,09	812	0.70	0.75
391	390		953		0.70
471	470		1,289		0.60
561	560		1,430		0.54
681	680		1,599		0.52
821	820		1,768		0.50
102	1,000		1,989		0.48

Note:

Test Freq.(L): 100KHz/1V

Test Instrument: L- HP 4192A LF Impedance analyzer; RDC- CH502BC, Rated Current- HP4284+42841A or CH1061+CH301A

Rated current: The rated current indicates the current when the inductance decrease to 65%. Over of it's nominal value or D.C. current when the temperature rising

$\Delta T = 40^\circ\text{C}$ lower; whichever is lower.

Tolerance: M = $\pm 20\%$, T = $\pm 30\%$, N = $+40\% / -20\%$

Tolerance of Inductors: SCDS104R: 1.5 to 330 $\mu\text{H} \pm 30\%$; SCDS105R: 0.8 to 1,000 $\mu\text{H} \pm 30\%$

TAPE DIMENSIONS

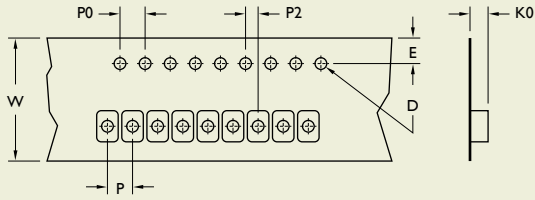

TAPE MATERIAL

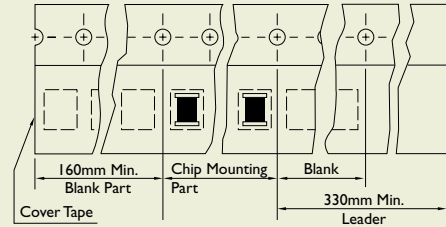

REEL DIMENSIONS

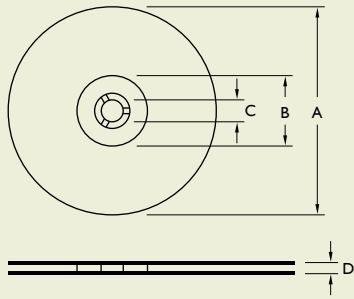

RECOMMENDED PATTERN

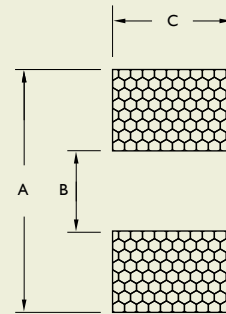

Dimensions: mm

TYPE	TAPE DIMENSIONS							RECOMMENDED PATTERN			REEL DIMENSIONS				QUANTITY/ REEL
	K0	D	E	W	P	P0	P2	A	B	C	A	B	C	D	
SCDS104R	4.10	1.50	1.75	24	16	4	2	1.6	7.3	3.2	330	100	13	24.4	1,000
SCDS105R	5.00	1.50	1.75	24	16	4	2	1.6	7.3	3.2	330	100	13	24.4	500

SMD Power Inductors

SCDS Series



PRODUCT IDENTIFICATION

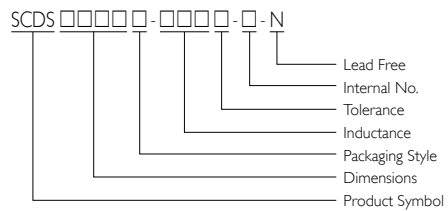
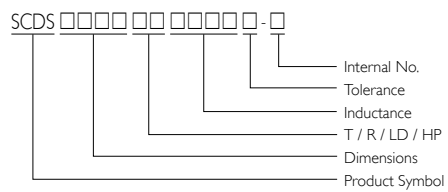

- T = Tape and Reel, R = Core Style (Round), LD = Low DCR, HP = High Power
- Internal No.: S = Base Type Terminals, N = Lead-Free

APPLICATIONS

Power Supply for VTRs

OA Equipment

LCD Televisions

Notebook PCs

Portable Communication Equipment

DC-DC Converters, etc.

FEATURES

Available in magnetically shielded

Low DC resistance

Suitable for large currents

Ideal for a variety of DC-DC converter inductor applications.

Available on tape and reel for auto surface mounting.

SHAPES AND DIMENSIONS

Unit: mm

Figure 1

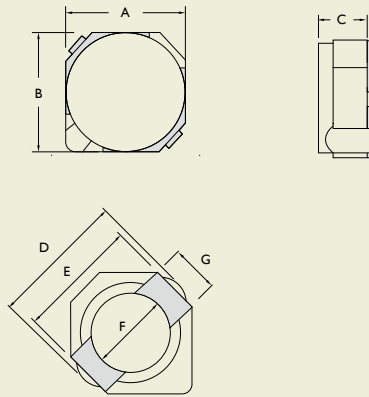

Figure 2

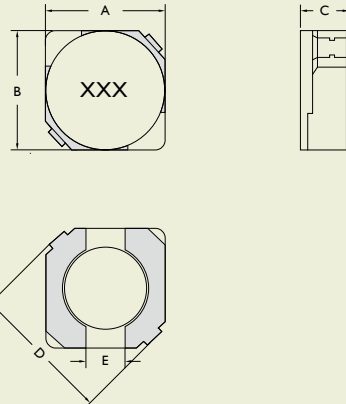
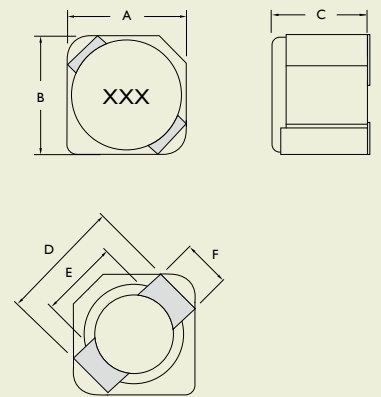

Figure 3



TYPE	FIGURE	A	B	C	D	E	F	G
SCDS2D09	1	3.2 ⁺⁰	3.2 ⁺⁰	1.0 ⁺⁰	4.5 ⁺⁰	3.3	2.1	1.0
SCDS2D11	1	3.2 ⁺⁰	3.2 ⁺⁰	1.2 ⁺⁰	4.5 ⁺⁰	3.3	2.1	1.0
SCDS2D14	1	3.2 ⁺⁰	3.2 ⁺⁰	1.55 ⁺⁰	4.5 ⁺⁰	3.3	2.1	1.0
SCDS2D18LD	1	3.2 ⁺⁰	3.2 ⁺⁰	2.0 ⁺⁰	4.5 ⁺⁰	3.3	2.1	1.0
SCDS2D18HP	1	3.2 ⁺⁰	3.2 ⁺⁰	2.0 ⁺⁰	4.5 ⁺⁰	3.3	2.1	1.0
SCDS3D11	1	4.0 ⁺⁰	4.0 ⁺⁰	1.2 ⁺⁰	5.2 ⁺⁰	4.4	2.8	1.1
SCDS3D11HP	1	4.0 ⁺⁰	4.0 ⁺⁰	1.2 ⁺⁰	5.2 ⁺⁰	4.4	2.8	1.1
SCDS3D16	2	4.0 ⁺⁰	4.0 ⁺⁰	1.8 ⁺⁰	5.2 ⁺⁰	1.0		
SCDS3D28	3	4.0 ⁺⁰	4.0 ⁺⁰	3 ⁺⁰	4.4	2.8	1.1	
SCDS3D28LD	3	4.0 ⁺⁰	4.0 ⁺⁰	3 ⁺⁰	4.4	2.8	1.1	
SCDS4D18	2	4.7 ± 0.3	4.7 ± 0.3	2.0 ⁺⁰	6.9 ⁺⁰	1.5		
SCDS4D28	2	4.7 ± 0.3	4.7 ± 0.3	3.0 ⁺⁰	6.9 ⁺⁰	1.5		
SCDS5D18	2	5.7 ± 0.3	5.7 ± 0.3	2.0 ⁺⁰	8.2 ⁺⁰	2.0		
SCDS5D28	2	5.7 ± 0.3	5.7 ± 0.3	3.0 ⁺⁰	8.2 ⁺⁰	2.0		
SCDS6D28	2	6.7 ± 0.3	6.7 ± 0.3	3.0 ⁺⁰	9.5 ⁺⁰	2.0		
SCDS6D38	2	7.0 ⁺⁰	7.0 ⁺⁰	4.0 ⁺⁰	9.5 ⁺⁰	2.0		



ELECTRICAL CHARACTERISTICS

STAMP	INDUCTANCE (μH)	DC RESISTANCE (Ω) Max.											
		SCDS 2D09	SCDS 2D11	SCDS 2D14	SCDS 2D18LD	SCDS 2D18H	SCDS 3D16	SCDS 4D18	SCDS 4D28	SCDS 5D18	SCDS 5D28	SCDS 6D28	SCDS 6D38
1R0	1.0							45					
1R2	1.2	97.5							23.6				
1R5	1.5	110	68	63			52						
1R7	1.7					44							
1R8	1.8	131.3		75					27.5				
2R2	2.2	143.8	98	94	41	60	72	75	31.3				
2R5	2.5										18		
2R7	2.7	150		106				105	43.3				
3R0	3.0										24	24	
3R3	3.3	193.8	123	125	54	86	85	110	49.2				20
3R9	3.9	225		138				155	64.8			27	
4R1	4.1									57			
4R2	4.2										31		
4R7	4.7	287.5	170	169	78	140	105	162	72				
5R0	5.0											31	24
5R3	5.3										38		
5R4	5.4									76			
5R6	5.6	325		188				170	100.9				
6R0	6.0											35	
6R2	6.2									96	45		27
6R3	6.3					160							
6R8	6.8	425	260	213	106		170	200	108.9				
7R3	7.3											54	
7R4	7.4												31
8R2	8.2	475		281				245	117.5		53		
8R6	8.6											58	
8R7	8.7												34
8R9	8.9									116			
100	10	537.5	400	294	180	245	210	280	128.3	124	65	65	38
120	12			394				320	131.6	153	76	70	53
150	15				220	345	295	360	149	196	103	84	57
180	18							400	166	210	110	95	92
220	22				320		430	480	235	290	122	128	96
270	27							570	261	330	175	142	109
330	33				460		675	694	331.3	386	189	165	124
390	39							800	383.7	520	212	210	138
470	47				660			950	587	595	250	238	150
560	56							1,080	624.5	665	305	277	202
680	68							1,300	699	840	355	304	234
820	82								914.8	978	463	390	324
101	100								1,020	1,200	520	535	358
121	120								1,270				
151	150								1,350				
181	180								1,540				

Note:

Test Freq.(L): SCDS2D09/2D11/2D14/2D18LP/2D18HP/4D28: 100KHz/1V

SCDS4D18: 1.0 to 8.2 μH (7.96MHz/1V), 10 to 39 μH (100KHz/1V)

SCDS3D16: 100KHz/0.1V; SCDS5D18/5D28/6D28/6D38: 10KHz/1V

Test Instrument: L- HP 4192A LF Impedance analyzer; RDC- CH502BC, Rated Current- HP4284+42841A or CH1061+CH301A

D.C. current when the temperature rising $\Delta T = 40^\circ\text{C}$ lower; whichever is lower:

Tolerance: M = $\pm 20\%$, T = $\pm 30\%$, N = $+40\%$ / -20%

ELECTRICAL CHARACTERISTICS

STAMP	INDUCTANCE (μH)	RATED CURRENT (A)											
		SCDS 2D09	SCDS 2D11	SCDS 2D14	SCDS 2D18LD	SCDS 2D18H	SCDS 3D16	SCDS 4D18	SCDS 4D28	SCDS 5D18	SCDS 5D28	SCDS 6D28	SCDS 6D38
IR0	1.0							1.72					
IR2	1.2	0.80							2.56				
IR5	1.5	0.73	0.90	1.80			1.55						
IR7	1.7					1.85							
IR8	1.8	0.65		1.65					2.20				
2R2	2.2	0.60	0.78	1.50	0.85	1.60	1.20	1.32	2.04				
2R5	2.5										2.60		
2R7	2.7	0.53		1.35				1.28	1.60				
3R0	3.0										2.40	3.00	
3R3	3.3	0.47	0.60	1.20	0.75	1.45	1.10	1.04	1.57				3.50
3R9	3.9	0.45		1.10				0.88	1.44			2.60	
4R1	4.1									1.95			
4R2	4.2										2.20		
4R7	4.7	0.41	0.50	1.00	0.63	1.20	0.90	0.84	1.32				
5R0	5.0											2.40	2.90
5R3	5.3										1.90		
5R4	5.4									1.60			
5R6	5.6	0.37		0.95				0.80	1.17				
6R0	6.0											2.25	
6R2	6.2									1.40	1.80		2.50
6R3	6.3					1.05							
6R8	6.8	0.33	0.44	0.85	0.52		0.73	0.76	1.12				
7R3	7.3											2.10	
7R4	7.4												2.30
8R2	8.2	0.30		0.80				0.68	1.04		1.60		
8R6	8.6											1.85	
8R7	8.7												2.20
8R9	8.9									1.25			
100	10	0.28	0.35	0.70	0.43	0.85	0.55	0.61	1.00	1.20	1.30	1.70	2.00
120	12			0.62				0.56	0.84	1.10	1.20	1.55	1.70



ELECTRICAL CHARACTERISTICS

STAMP	INDUCTANCE (μH)	RATED CURRENT (A)											
		SCDS 2D09	SCDS 2D11	SCDS 2D14	SCDS 2D18LD	SCDS 2D18H	SCDS 3D16	SCDS 4D18	SCDS 4D28	SCDS 5D18	SCDS 5D28	SCDS 6D28	SCDS 6D38
150	15				0.35	0.70	0.45	0.50	0.76	0.97	1.10	1.40	1.60
180	18							0.48	0.72	0.85	1.00	1.32	1.50
220	22				0.30		0.40	0.41	0.70	0.80	0.90	1.20	1.30
270	27							0.35	0.58	0.75	0.85	1.05	1.20
330	33				0.24		0.32	0.32	0.56	0.65	0.75	0.97	1.10
390	39							0.30	0.50	0.57	0.70	0.86	1.00
470	47				0.20			0.28	0.48	0.54	0.62	0.80	0.95
560	56							0.26	0.41	0.50	0.58	0.73	0.85
680	68							0.24	0.35	0.43	0.52	0.65	0.75
820	82								0.32	0.41	0.46	0.60	0.70
101	100								0.29	0.36	0.42	0.54	0.65
121	120								0.27				
151	150								0.24				
181	180								0.22				

Note:

Test Freq.(L): SCDS2D09/2D11/2D14/2D18LP/2D18HP/4D28: 100KHz/1V

SCDS4D18: 1.0 to 8.2 μH (7.96MHz/1V), 10 to 39 μH (100KHz/1V)

SCDS3D16: 100KHz/0.1V; SCDS5D18/5D28/6D28/6D38: 10KHz/1V

Test Instrument: L- HP 4192A LF Impedance analyzer; RDC- CH502BC, Rated Current- HP4284+42841A or CH1061+CH301A

D.C. current when the temperature rising $\Delta T = 40^\circ\text{C}$ lower; whichever is lower:

Tolerance: M = $\pm 20\%$, T = $\pm 30\%$, N = $+40\%$ / -20%

TOLERANCE OF INDUCTORS

SCDS2D09	1.2 to 10 $\mu\text{H} \pm 30\%$	SCDS3D28	3.3 to 47 $\mu\text{H} \pm 30\%$
SCDS2D11	1.5 to 10 $\mu\text{H} \pm 30\%$	SCDS3D28LD	10 to 220 $\mu\text{H} \pm 30\%$
SCDS2D14	1.5 to 12 $\mu\text{H} \pm 30\%$	SCDS4D18	1.0 to 68 $\mu\text{H} \pm 30\%$
SCDS2D18LD	2.2 to 47 $\mu\text{H} \pm 30\%$	SCDS4D28	1.2 to 180 $\mu\text{H} \pm 30\%$
SCDS2D18HP	1.7 to 15 $\mu\text{H} \pm 30\%$	SCDS5D18	4.1 to 100 $\mu\text{H} \pm 30\%$
SCDS3D11	2.7 to 39 $\mu\text{H} \pm 30\%$	SCDS5D28	2.5 to 100 $\mu\text{H} \pm 30\%$
SCDS311HP	0.6 to 22 $\mu\text{H} \pm 30\%$	SCDS6D28	3.0 to 100 $\mu\text{H} \pm 30\%$
SCDS3D16	1.5 to 33 $\mu\text{H} \pm 30\%$	SCDS6D38	3.3 to 100 $\mu\text{H} \pm 30\%$

ELECTRICAL CHARACTERISTICS

STAMP	INDUCTANCE (μ H)	DC RESISTANCE (Ω) Max.				RATED CURRENT (A)				I _{rms} (A) Typ.			
		SCDS 3D11	SCDS 3D11HP	SCDS 3D28	SCDS 3D28LD	SCDS 3D11	SCDS 3D11HP	SCDS 3D28	SCDS 3D28LD	SCDS 3D11	SCDS 3D11HP	SCDS 3D28	SCDS 3D28LD
R60	0.6		0.059				2.90				1.80		
1R2	1.2		0.082				2.00				1.70		
1R5	1.5		0.104				1.85				1.45		
2R2	2.2		0.143				1.60				1.15		
2R7	2.7	0.078				0.53				1.82			
3R3	3.3		0.182	0.0721			1.25	2.00			0.95	1.85	
4R7	4.7	0.123	0.234	0.0883		0.40	1.00	1.65		1.38	0.90	1.62	
6R8	6.8	0.180	0.377	0.1190		0.34	0.85	1.24		1.05	0.70	1.32	
8R2	8.2	0.204				0.32				0.93			
100	10	0.240	0.413	0.1450	0.095	0.28	0.80	1.05	0.50	0.90	0.60	1.18	1.52
120	12	0.276	0.585		0.100	0.25	0.64		0.45	0.81	0.48		1.48
150	15	0.372	0.653	0.2130	0.115	0.23	0.58	0.90	0.40	0.68	0.45	1.02	1.44
180	18	0.468	0.888		0.125	0.21	0.52		0.35	0.58	0.40		1.37
220	22	0.540	1.010	0.3350	0.145	0.19	0.45	0.76	0.33	0.53	0.33	0.74	1.28
270	27	0.726			0.175	0.17			0.29	0.48			1.18
330	33	0.822		0.4810	0.215	0.15		0.58	0.28	0.41		0.63	1.15
390	39	0.942			0.225	0.14			0.25	0.40			1.00
470	47			0.5990	0.305			0.48	0.23			0.56	0.81
560	56				0.325				0.20				0.76
680	68				0.470				0.19				0.60
820	82				0.540				0.17				0.58
101	100				0.610				0.16				0.52
121	120				0.755				0.14				0.50
151	150				0.880				0.12				0.48
181	180				1.130				0.12				0.42
221	220				1.270				0.12				0.36

Note:

Test Freq.(L): 100KHz/1V

Test Instrument: L- HP4284A, RDC- CH502BC, Rated Current- HP4284+42841A or CH1061+CH301A

Rated current: The rated current indicates the current when the inductance decreases to 65%

I_{rms}: D.C. current when the temperature rising $\Delta T = 40^\circ\text{C}$

Tolerance: T = $\pm 30\%$



TAPE DIMENSIONS

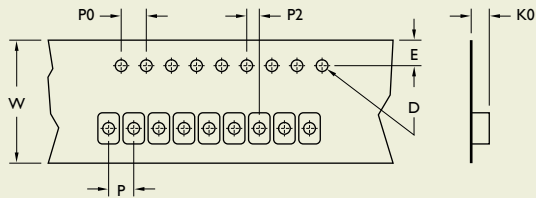

TAPE MATERIAL

Carrier Tape: Polystyrene

Cover Tape: Polyethylene

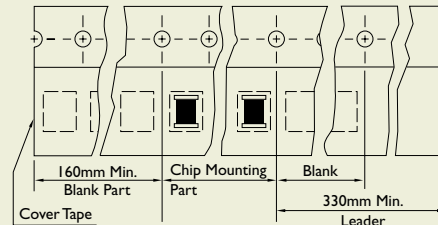

REEL DIMENSIONS

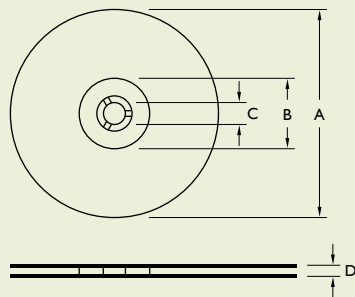

RECOMMENDED PATTERN

Figure 1

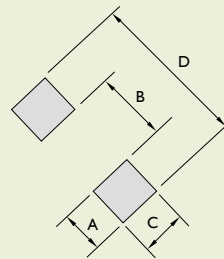
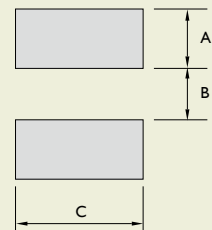

Figure 2



Dimensions: mm

TYPE	TAPE DIMENSIONS							RECOMMENDED PATTERN				REEL DIMENSIONS				QUANTITY/ REEL	
	K0	D	E	W	P	P0	P2	FIGURE A	B	C	D	A	B	C	D		
SCDS2D09	1.40	1.55	1.75	12	8	4	2	1	1.3	1.7	1.3	4.3	178	60	13	13.2	1,000
SCDS2D11	1.40	1.55	1.75	12	8	4	2	1	1.3	1.7	1.3	4.3	178	60	13	13.2	1,000
SCDS2D14	1.70	1.55	1.75	12	8	4	2	1	1.3	1.7	1.3	4.3	178	60	13	13.2	1,000
SCDS2D18LD	2.10	1.55	1.75	12	8	4	2	1	1.3	1.7	1.3	4.3	178	60	13	13.2	1,000
SCDS2D18HP	2.10	1.55	1.75	12	8	4	2	1	1.3	1.7	1.3	4.3	178	60	13	13.2	1,000
SCDS3D11	1.50	1.55	1.75	12	8	4	2	1	1.4	2.4	1.5	5.2	178	60	13	13.2	1,000
SCDS3D11HP	1.50	1.55	1.75	12	8	4	2	1	1.4	2.4	1.5	5.2	178	60	13	13.2	1,000
SCDS3D16	2.00	1.50	1.75	12	8	4	2	2	1.6	1.4	4.6	-	178	60	13	13.2	1,000
SCDS3D28	3.20	1.55	1.75	12	8	4	2	1	1.4	2.4	1.5	5.2	178	60	13	13.2	500
SCDS3D28LD	3.20	1.55	1.75	12	8	4	2	1	1.4	2.4	1.5	5.2	178	60	13	13.2	500
SCDS4D18	2.40	1.50	1.75	12	8	4	2	2	1.9	1.5	5.3	-	330	100	13	13.4	2,000
SCDS4D28	3.40	1.50	1.75	12	8	4	2	2	1.9	1.5	5.3	-	330	100	13	13.4	2,000
SCDS5D18	2.20	1.50	1.75	12	8	4	2	2	2.15	2.0	6.3	-	330	100	13	13.4	2,000
SCDS5D28	3.20	1.50	1.75	12	8	4	2	2	2.15	2.0	6.3	-	330	100	13	13.4	2,000
SCDS6D28	3.20	1.50	1.75	16	12	4	2	2	2.65	2.0	7.3	-	330	100	13	17.4	1,500
SCDS6D38	4.10	1.50	1.75	16	12	4	2	2	2.65	2.0	7.3	-	330	100	13	17.4	1,000

SDS0402 Series

SMD Power Inductors

FEATURES

Smallest Size and High Performance.

High Energy Storage and Very Low Resistance.

ELECTRICAL CHARACTERISTICS

PART NO.	INDUCTANCE * (μ H)	Q Min.	Q FREQUENCY (KHz)	DC RESISTANCE (Ω) Max.	SRF (MHz) Typ.	I _{rms} ** (A)
SDS0402T-1R0M-N	1.0	30	200	0.040	200	3.00
SDS0402T-1R5M-N	1.5	30	200	0.045	100	2.80
SDS0402T-2R2M-N	2.2	40	200	0.050	90	1.80
SDS0402T-3R3M-N	3.3	40	200	0.060	90	1.60
SDS0402T-4R7M-N	4.7	40	200	0.065	80	1.40
SDS0402T-6R8M-N	6.8	40	200	0.070	40	1.20
SDS0402T-100M-N	10	40	200	0.075	30	1.00
SDS0402T-150M-N	15	40	100	0.090	25	0.80
SDS0402T-220M-N	22	40	100	0.110	20	0.70
SDS0402T-330M-N	33	40	100	0.190	15	0.60
SDS0402T-470M-N	47	40	100	0.230	15	0.50
SDS0402T-680M-N	68	40	100	0.290	10	0.40
SDS0402T-101M-N	100	40	100	0.480	8.0	0.30
SDS0402T-151M-N	150	40	100	0.590	7.0	0.26
SDS0402T-221M-N	220	40	100	0.770	4.0	0.22
SDS0402T-331M-N	330	40	100	1.4	4.0	0.20
SDS0402T-471M-N	470	40	100	1.8	3.0	0.19
SDS0402T-681M-N	680	40	100	2.2	2.0	0.18
SDS0402T-102M-N	1,000	40	100	3.4	1.0	0.15
SDS0402T-152M-N	1,500	50	100	4.2	1.0	0.12
SDS0402T-222M-N	2,200	50	100	8.5	1.0	0.10
SDS0402T-332M-N	3,300	50	100	11	0.5	0.08
SDS0402T-472M-N	4,700	50	100	13.9	0.5	0.06
SDS0402T-682M-N	6,800	50	100	25	0.5	0.04
SDS0402T-103M-N	10,000	50	100	32.8	0.4	0.02

Note:

* Inductance Tested at 1KHz, 1 Vrms.

** 30 °C Temperature Rise at I_{rms}.

Tolerance: M = \pm 20%

Operating Temperature Range: -40 °C to +85 °C



PRODUCT IDENTIFICATION

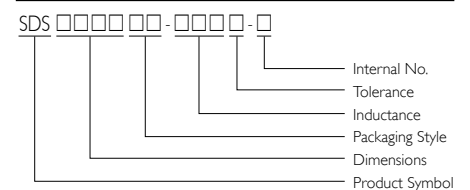

■ Packaging: T = Tape and Reel

■ Internal No.: N = Lead-Free

SHAPES AND DIMENSIONS

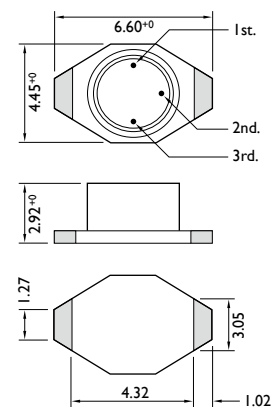

Dimensions: mm

SMD Power Inductors

SDS0402BL Series



PRODUCT IDENTIFICATION

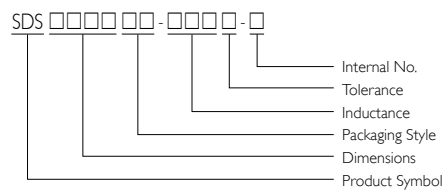

- Packaging: T = Tape and Reel
- Internal No.: N = Lead-Free

SHAPES AND DIMENSIONS

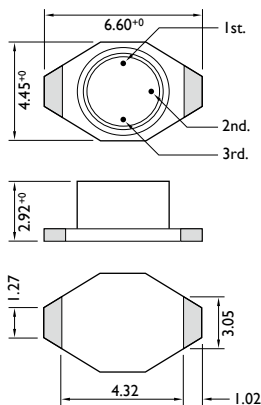

Dimensions: mm

APPLICATIONS

Notebook Computers, Step-up and Step-down Converters.

Flash Memory Programmers, etc.

OUTLINE

These shielded ultra-miniature inductors can help designers achieve significantly longer battery life in handheld communication devices and other portable products.

These magnetically shielded inductors are designed with a flat top and constructed of heat resistant materials to ensure trouble-free assembly and reflow operations.

FEATURES

Smallest Size and High Performance.

High Energy Storage and Very Low Resistance.

ELECTRICAL CHARACTERISTICS

PART NO.	INDUCTANCE * (mH)	DC RESISTANCE (Ω) Max.	INSULATION CORE-WINDING (MΩ)	SRF (MHz) Typ.	I _{rms} ** (A)
SDS0402BL-101M-N	0.10	0.95	> 10	12	220
SDS0402BL-151M-N	0.15	1.4	> 10	10	200
SDS0402BL-221M-N	0.22	1.7	> 10	8.0	180
SDS0402BL-331M-N	0.33	2.2	> 10	6.0	160
SDS0402BL-471M-N	0.47	3.8	> 10	5.0	140
SDS0402BL-681M-N	0.68	4.9	> 10	4.0	120
SDS0402BL-102M-N	1.0	9.0	> 10	2.0	100
SDS0402BL-152M-N	1.5	11	> 10	1.0	80
SDS0402BL-222M-N	2.2	19	> 10	1.0	50
SDS0402BL-332M-N	3.3	24	> 10	1.0	40
SDS0402BL-472M-N	4.7	30	> 10	1.0	30
SDS0402BL-682M-N	6.8	56	> 10	0.9	20
SDS0402BL-103M-N	10	74	> 10	0.8	10

Note:

* Inductance Tested at 100KHz, 0.1 V_{rms}.

** 30 °C Temperature Rise at I_{rms}.

Tolerance: M = ± 20%

Operating Temperature Range: -40 °C to +85 °C

Electrical Specifications at 25 °C

SDS0804 Series

SMD Power Inductors

APPLICATIONS

Notebook Computers, Step-up and Step-down Converters.

Flash Memory Programmers, etc.

OUTLINE

These shielded ultra-miniature inductors can help designers achieve significantly longer battery life in handheld communication devices and other portable products.

These magnetically shielded inductors are designed with a flat top and constructed of heat resistant materials to ensure trouble-free assembly and reflow operations.

FEATURES

Smallest Size and High Performance.

High Energy Storage and Very Low Resistance.

ELECTRICAL CHARACTERISTICS

PART NO.	INDUCTANCE * (mH)	Q Min.	Q FREQUENCY (KHz)	DC RESISTANCE (Ω) Max.	SRF (MHz) Typ.	Isat ** (A)	Irms *** (A)
SDS0804T-1R0M-N	1.0	3	100	0.021	110	5.6	5.0
SDS0804T-1R5M-N	1.5	5	100	0.022	90	5.2	4.5
SDS0804T-2R2M-N	2.2	5	100	0.032	60	5.0	3.8
SDS0804T-3R3M-N	3.3	5	100	0.039	55	3.9	3.3
SDS0804T-4R7M-N	4.7	10	100	0.054	30	3.2	2.7
SDS0804T-6R8M-N	6.8	10	100	0.075	30	2.8	2.2
SDS0804T-100M-N	10	10	100	0.101	28	2.4	2.0
SDS0804T-150M-N	15	15	100	0.150	20	2.0	1.5
SDS0804T-220M-N	22	20	100	0.207	15	1.6	1.3
SDS0804T-330M-N	33	20	100	0.334	12	1.4	1.1
SDS0804T-470M-N	47	20	100	0.472	10	1.0	0.8

Note:

* Inductance Tested at 100KHz, 0.1 Vrms.

** Inductance Drop = 10% Typ. at Rated Isat.

*** 40 °C Temperature Rise Typ. at Irms.

Tolerance: M = \pm 20%

Operating Temperature Range: -40 °C to +85 °C



PRODUCT IDENTIFICATION

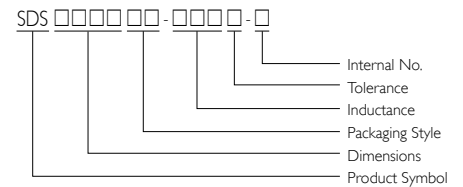

■ Packaging: T = Tape and Reel

■ Internal No.: N = Lead-Free

SHAPES AND DIMENSIONS

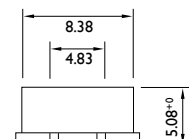
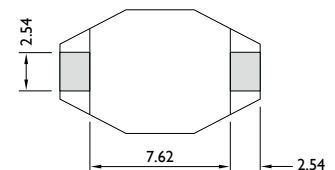
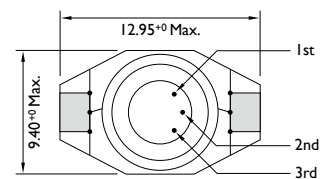

Dimensions: mm

SMD Power Inductors

SDSI 306 Series



PRODUCT IDENTIFICATION

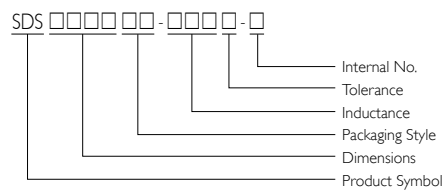

■ Packaging: T = Tape and Reel

■ Internal No.: N = Lead-Free

SHAPES AND DIMENSIONS

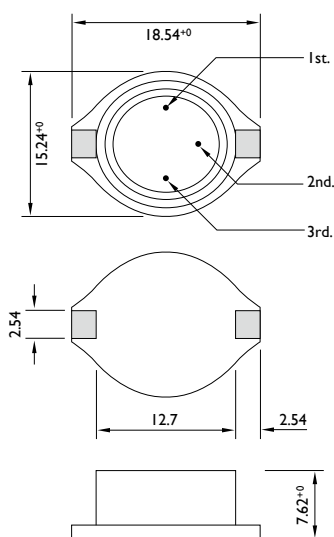

Dimensions: mm

APPLICATIONS

Notebook Computers, Step-up and Step-down Converters.

Flash Memory Programmers, etc.

OUTLINE

These shielded ultra-miniature inductors can help designers achieve significantly longer battery life in handheld communication devices and other portable products.

These magnetically shielded inductors are designed with a flat top and constructed of heat resistant materials to ensure trouble-free assembly and reflow operations.

FEATURES

Smallest Size and High Performance.

High Energy Storage and Very Low Resistance.

ELECTRICAL CHARACTERISTICS

PART NO.	INDUCTANCE * (μ H)	Q Min.	Q FREQUENCY (KHz)	DC RESISTANCE (Ω) Max.	SRF (MHz) Typ.	Isat ** (A)	Irms *** (A)
SDSI 306T-100M-N	10	40	100	0.040	24	5.50	3.90
SDSI 306T-150M-N	15	40	100	0.048	16	4.50	3.40
SDSI 306T-220M-N	22	30	100	0.059	14	3.50	3.10
SDSI 306T-330M-N	33	40	100	0.075	11	3.30	2.80
SDSI 306T-470M-N	47	40	100	0.097	8.0	2.70	2.40
SDSI 306T-680M-N	68	40	100	0.140	7.0	2.20	2.00
SDSI 306T-101M-N	100	40	100	0.210	5.5	1.70	1.70
SDSI 306T-151M-N	150	50	100	0.300	4.8	1.30	1.30
SDSI 306T-221M-N	220	50	100	0.470	4.0	1.10	1.10
SDSI 306T-331M-N	330	50	100	0.780	3.0	0.86	0.86
SDSI 306T-471M-N	470	50	100	1.08	2.4	0.73	0.73
SDSI 306T-681M-N	680	60	100	1.40	2.0	0.64	0.64
SDSI 306T-102M-N	1,000	60	100	2.01	1.0	0.53	0.53

Note:

* Inductance Tested at 100KHz, 0.1 Vrms.

** Inductance Drop = 10% Typ. at Rated Isat.

*** 40 °C Temperature Rise Typ. at Irms.

Tolerance: M = \pm 20%

Operating Temperature Range: -40 °C to +85 °C

TAPE DIMENSIONS

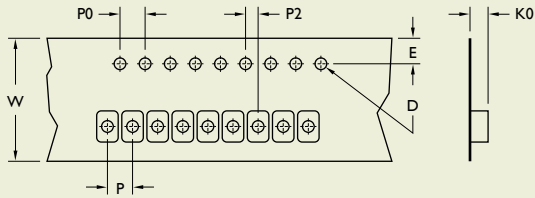

TAPE MATERIAL

Carrier Tape: Polystyrene

Cover Tape: Polyethylene

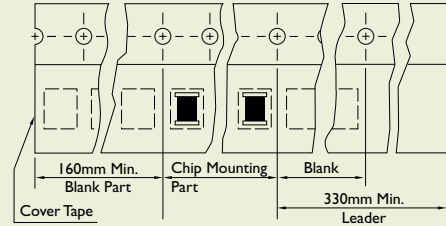

REEL DIMENSIONS

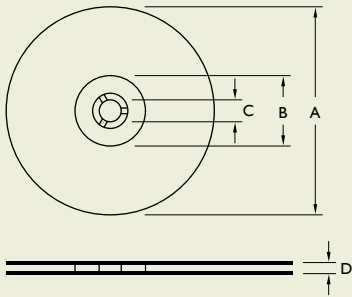

RECOMMENDED PATTERN

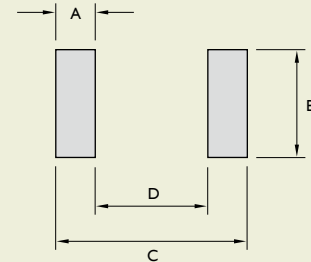

Dimensions: mm

TYPE	TAPE DIMENSIONS							RECOMMENDED PATTERN				REEL DIMENSIONS				QUANTITY/ REEL	
	K0	D	E	W	P	P0	P2	A	B	C	D	A	B	C	D	178	330
SDS0402T	3.2	1.55	1.75	12	8	4	2	1.40	3.56	6.86	4.06	330	100	13	13.4	-	2,500
												178	60	13	13.2	750	-
SDS0402BL	3.2	1.55	1.75	12	8	4	2	1.40	3.56	6.86	4.06	330	100	13	13.4	-	2,500
												178	60	13	13.2	750	-
SDS0804T	5.4	1.55	1.75	24	12	4	2	2.92	2.79	13.21	7.37	330	100	13	24.4	-	1,000
SDS1306T	7.5	1.55	1.75	32	20	4	2	2.92	2.79	18.29	12.45	330	100	13	33.4	-	250

SMD Power Inductors

SDT0402 Series



PRODUCT IDENTIFICATION

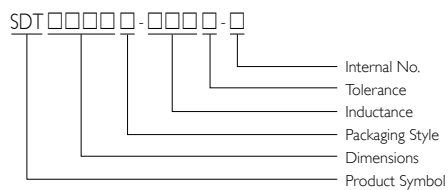

- Packaging: T = Tape and Reel
- Internal No.: N = Lead-Free

SHAPES AND DIMENSIONS

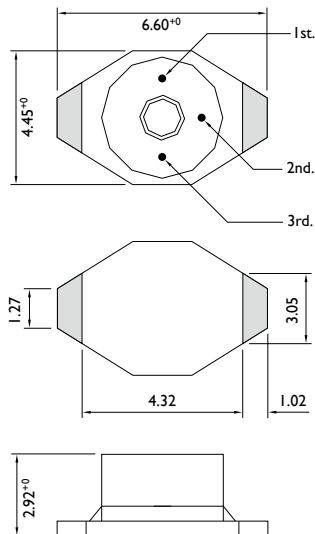

Dimensions: mm

APPLICATIONS

Board mounted DC-DC converters

Miniature power supplies, and voltage multiplying circuits.

FEATURES

Ultra High L and low current

Functions equally well in filter and smoothing circuit applications.

ELECTRICAL CHARACTERISTICS

SPECIFICATIONS

PART NO.	INDUCTANCE at 100KHz ($\mu\text{H} \pm 20\%$)	DC RESISTANCE (Ω) Max.	OPERATING PARAMETERS				
			SRF (MHz) Typ.	INDUCTANCE RATING * (μH)	CURRENT RATING ** (A)	ENERGY STORAGE (μJoules) Max.	SWITCHING FREQUENCY Max.
SDT0402T-1R0M-N	1.0	0.045	157	0.60	2.00	1.8	1 MHz
SDT0402T-1R5M-N	1.5	0.050	108	0.80	1.90	1.8	1 MHz
SDT0402T-2R2M-N	2.2	0.060	92	0.90	1.50	1.8	1 MHz
SDT0402T-3R3M-N	3.3	0.070	69	1.50	1.20	1.4	1 MHz
SDT0402T-4R7M-N	4.7	0.080	59	2.00	1.20	1.6	1 MHz
SDT0402T-6R8M-N	6.8	0.085	51	3.00	1.00	1.9	1 MHz
SDT0402T-100M-N	10	0.095	33	5.00	0.70	1.2	1 MHz
SDT0402T-150M-N	15	0.135	26	6.00	0.60	1.1	1 MHz
SDT0402T-220M-N	22	0.160	20	10	0.50	1.2	1 MHz
SDT0402T-330M-N	33	0.275	17	12	0.45	1.5	1 MHz
SDT0402T-470M-N	47	0.340	12	20	0.34	1.3	1 MHz
SDT0402T-680M-N	68	0.575	11	30	0.29	1.4	1 MHz
SDT0402T-101M-N	100	1.100	9.40	40	0.24	1.5	1 MHz
SDT0402T-151M-N	150	1.400	6.70	60	0.20	1.4	500 KHz
SDT0402T-221M-N	220	2.250	6.10	90	0.17	1.6	500 KHz
SDT0402T-331M-N	330	2.900	4.70	100	0.16	1.4	500 KHz
SDT0402T-471M-N	470	3.600	3.85	150	0.14	1.5	500 KHz
SDT0402T-681M-N	680	4.550	3.10	200	0.12	1.4	500 KHz
SDT0402T-102M-N	1,000	8.100	2.30	400	0.08	1.4	500 KHz

Note:

*Measured at the rated current

**Average maximum allowable current. SDT Series inductors are designed for current spikes as high as 2X the current rating

Operating Temperature Range: $-40\text{ }^{\circ}\text{C}$ to $+85\text{ }^{\circ}\text{C}$

SDT0804 Series

SMD Power Inductors

APPLICATIONS

Board mounted DC-DC converters

Miniature power supplies, and voltage multiplying circuits.

FEATURES

Ultra High L and low current

Functions equally well in filter and smoothing circuit applications.

ELECTRICAL CHARACTERISTICS

SPECIFICATIONS			OPERATING PARAMETERS				
PART NO.	INDUCTANCE at 100KHz ($\mu\text{H} \pm 20\%$)	DC RESISTANCE (Ω) Max.	SRF (MHz) Typ.	INDUCTANCE RATING * (μH)	CURRENT RATING ** (A)	ENERGY STORAGE (μ Joules) Max.	SWITCHING FREQUENCY Max.
SDT0804T-1R0M-N	1.0	0.025	60	0.50	5.0	9	1 MHz
SDT0804T-1R5M-N	1.5	0.030	55	0.70	5.0	12	1 MHz
SDT0804T-2R2M-N	2.2	0.035	55	1.00	5.0	15	1 MHz
SDT0804T-3R3M-N	3.3	0.040	50	1.50	5.0	16	1 MHz
SDT0804T-4R7M-N	4.7	0.045	45	2.00	3.0	10	1 MHz
SDT0804T-6R8M-N	6.8	0.050	40	4.00	2.5	14	1 MHz
SDT0804T-100M-N	10	0.055	35	5.00	2.0	11	1 MHz
SDT0804T-150M-N	15	0.060	25	6.00	1.8	12	1 MHz
SDT0804T-220M-N	22	0.084	22	10	1.5	11	1 MHz
SDT0804T-330M-N	33	0.090	18	12	1.3	13	1 MHz
SDT0804T-470M-N	47	0.11	16	27	1.0	13	1 MHz
SDT0804T-680M-N	68	0.15	12	40	0.90	17	1 MHz
SDT0804T-101M-N	100	0.29	9.0	50	0.80	15	1 MHz
SDT0804T-151M-N	150	0.36	8.0	80	0.60	15	500 KHz
SDT0804T-221M-N	220	0.39	6.0	90	0.50	10	500 KHz
SDT0804T-331M-N	330	0.73	5.0	150	0.40	13	500 KHz
SDT0804T-471M-N	470	0.88	4.0	200	0.35	13	500 KHz
SDT0804T-681M-N	680	1.15	3.0	300	0.30	13	500 KHz
SDT0804T-102M-N	1,000	1.45	2.5	420	0.25	13	500 KHz

Note:

*Measured at the rated current

**Average maximum allowable current. SDT Series inductors are designed for current spikes as high as 2X the current rating

Operating Temperature Range: -40 °C to +85 °C



PRODUCT IDENTIFICATION

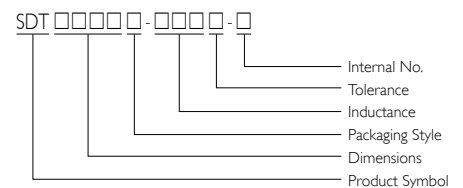

■ Packaging: T = Tape and Reel

■ Internal No.: N = Lead-Free

SHAPES AND DIMENSIONS

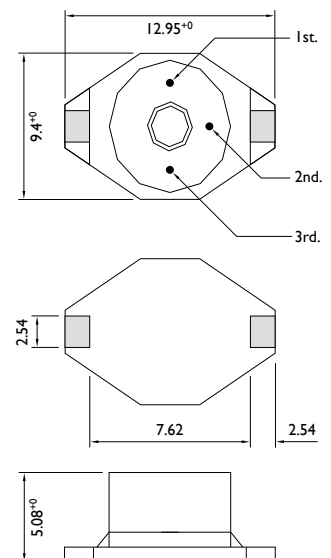

Dimensions: mm



TAPE DIMENSIONS

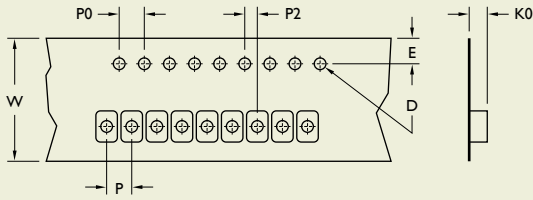

TAPE MATERIAL

Carrier Tape: Polystyrene

Cover Tape: Polyethylene

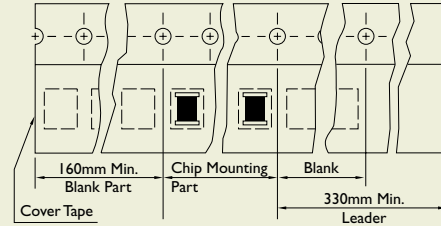

REEL DIMENSIONS

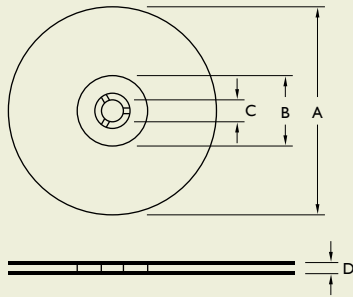

RECOMMENDED PATTERN

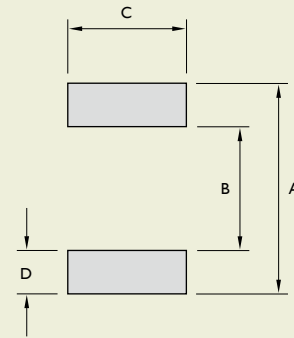

TYPE	TAPE DIMENSIONS							RECOMMENDED PATTERN				REEL DIMENSIONS				QUANTITY/ REEL	
	K0	D	E	W	P	P0	P2	A	B	C	D	A	B	C	D	178	330
	SDT0402	3.20	1.55	1.75	12	8	4	2	6.86	4.06	3.56	1.40	330	100	13	13.4	-
												178	60	13	13.2	750	-
SDT0804	5.40	1.55	1.75	24	16	4	2	13.21	7.37	2.79	2.92	330	100	13	24.4	-	750

Dimensions: mm

SLF Series

SMD Power Inductors

APPLICATIONS

Portable telephones, computers, hard disk drives and other electronic equipment.

OUTLINE

SLF series is designed for low profile type with low Rdc and large current.

Its magnetic shielded type is suitable for high-density mounting and flat bottom surface allows for reliable mounting onto the board.

Soldering conditions can be easily confirmed when mounting onto the board.

This series also provides customers with embossed carrier type packaging for automatic mounting machines.

FEATURES

Low Resistance and High Currents



PRODUCT IDENTIFICATION

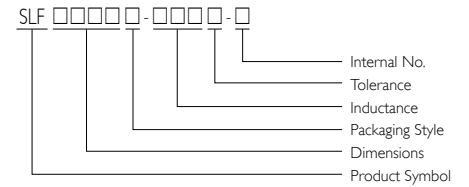

- Packaging: T = Tape and Reel
- Internal No.: N = Lead-Free



SHAPES AND DIMENSIONS

Unit: mm

Figure 1

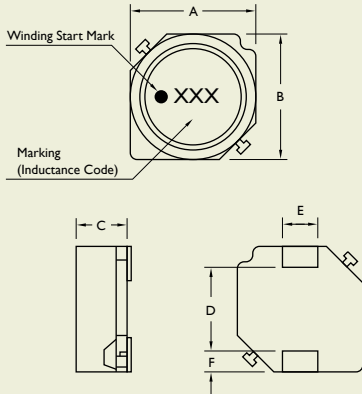

Figure 2

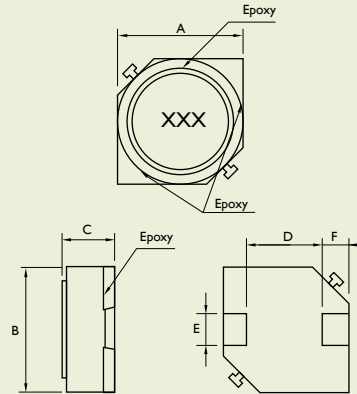
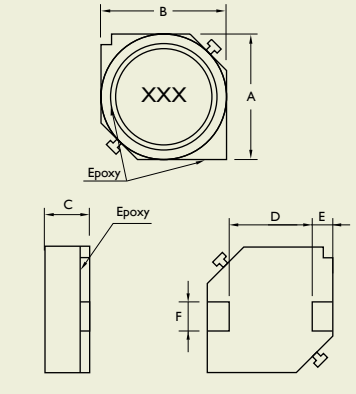

Figure 3



TYPE	FIGURE	A	B	C	D	E	F
SLF0628	1	6 ± 0.2	6 ± 0.2	2.8 ± 0.2	3.0 typ	2 ± 0.1	1.5 typ
SLF0728	1	7 ± 0.2	7 ± 0.2	2.8 ± 0.2	4.9 typ	2.0 typ	0.9 typ
SLF0730	1	7 ± 0.2	7 ± 0.2	3.0 ± 0.2	4.9 typ	2.0 typ	0.9 typ
SLF0732	1	7 ± 0.2	7 ± 0.2	3.2 ± 0.2	4.9 typ	2.0 typ	0.9 typ
SLF0745	1	7 ± 0.2	7 ± 0.2	4.5 ± 0.3	4.9 typ	2.0 typ	0.9 typ
SLF1045	2	10.1 ± 0.3	10.1 ± 0.3	4.5 ± 0.3	6.0 typ	3.0 typ	2.0 typ
SLF1055	2	10.1 ± 0.3	10.1 ± 0.3	5.5 ± 0.3	6.0 typ	3.0 typ	2.0 typ
SLF1255	3	12.5 ± 0.3	12.5 ± 0.3	5.5 ± 0.3	8.6 typ	3.0 typ	2.0 typ
SLF1265	3	12.5 ± 0.3	12.5 ± 0.3	6.5 ± 0.35	8.6 typ	3.0 typ	2.0 typ
SLF1275	3	12.5 ± 0.3	12.5 ± 0.3	7.5 ± 0.35	8.6 typ	3.0 typ	2.0 typ

ELECTRICAL CHARACTERISTICS SLF0628

PART NO.	INDUCTANCE (μ H)	TOLERANCE (\pm %)	TEST FREQUENCY (KHz)	DC RESISTANCE (Ω) \pm 20%	RATED CURRENT (A) Max.	ITEMP (A) Max.
SLF0628T-4R7M-N	4.7	20	I	0.0284	1.60	2.50
SLF0628T-6R8M-N	6.8	20	I	0.0354	1.50	2.20
SLF0628T-100M-N	10	20	I	0.0532	1.30	1.80
SLF0628T-150M-N	15	20	I	0.0745	1.00	1.40
SLF0628T-220M-N	22	20	I	0.104	0.77	1.30
SLF0628T-330M-N	33	20	I	0.148	0.69	1.10
SLF0628T-470M-N	47	20	I	0.210	0.59	0.92
SLF0628T-680M-N	68	20	I	0.290	0.50	0.78
SLF0628T-101M-N	100	20	I	0.430	0.42	0.64

Note:

Rated Current: Value obtained when DC current flows and the initial value of inductance has fallen by 30%.

Itemp Current: Value obtained when current flows and the temperature has risen to 25 °C.

Test Equipment Inductance: HP4192A LF Impedance analyzer or equivalent (Test frequency: 1KHz/0.5V)

RDC: CH502BC

ELECTRICAL CHARACTERISTICS SLF0728

PART NO.	INDUCTANCE (μ H)	TOLERANCE (\pm %)	TEST FREQUENCY (KHz)	DC RESISTANCE (Ω) \pm 20%	RATED CURRENT (A) Max.
SLF0728T-3R3M-N	3.3	20	I	0.037	1.60
SLF0728T-4R7M-N	4.7	20	I	0.045	1.50
SLF0728T-6R8M-N	6.8	20	I	0.059	1.30
SLF0728T-100M-N	10	20	I	0.083	1.10
SLF0728T-150M-N	15	20	I	0.130	0.88
SLF0728T-220M-N	22	20	I	0.180	0.75
SLF0728T-330M-N	33	20	I	0.240	0.65
SLF0728T-470M-N	47	20	I	0.340	0.54

Note:

Rated Current: Value obtained when DC current flows and the initial value of inductance has fallen by 10%.

Test Equipment Inductance: HP4192A LF Impedance analyzer or equivalent (Test frequency: 1KHz/0.5V)

RDC: CH502BC



ELECTRICAL CHARACTERISTICS SLF0730

PART NO.	INDUCTANCE (μ H)	TOLERANCE (\pm %)	TEST FREQUENCY (KHz)	DC RESISTANCE (Ω) \pm 20%	RATED CURRENT (A) Max.
SLF0730T-3R3M-N	3.3	20		0.023	1.80
SLF0730T-4R7M-N	4.7	20		0.036	1.60
SLF0730T-6R8M-N	6.8	20		0.041	1.50
SLF0730T-100M-N	10	20		0.053	1.30
SLF0730T-150M-N	15	20		0.084	1.00
SLF0730T-220M-N	22	20		0.110	0.86
SLF0730T-330M-N	33	20		0.160	0.65
SLF0730T-470M-N	47	20		0.240	0.57
SLF0730T-680M-N	68	20		0.310	0.49
SLF0730T-101M-N	100	20		0.450	0.35

Note:

Rated Current: Value obtained when DC current flows and the initial value of inductance has fallen by 10%.

Test Equipment Inductance: HP4192A LF Impedance analyzer or equivalent (Test frequency: 1KHz/0.5V)

RDC: CH502BC

ELECTRICAL CHARACTERISTICS SLF0732

PART NO.	INDUCTANCE (μ H)	TOLERANCE (\pm %)	TEST FREQUENCY (KHz)	DC RESISTANCE (Ω) \pm 20%	RATED CURRENT (A) Max.
SLF0732T-2R2M-N	2.2	20		0.018	2.10
SLF0732T-3R3M-N	3.3	20		0.023	1.90
SLF0732T-4R7M-N	4.7	20		0.036	1.70
SLF0732T-6R8M-N	6.8	20		0.041	1.60
SLF0732T-100M-N	10	20		0.053	1.40
SLF0732T-150M-N	15	20		0.075	1.10
SLF0732T-220M-N	22	20		0.11	0.96
SLF0732T-330M-N	33	20		0.16	0.75
SLF0732T-470M-N	47	20		0.24	0.67
SLF0732T-680M-N	68	20		0.31	0.59
SLF0732T-101M-N	100	20		0.45	0.45
SLF0732T-151M-N	150	20		0.65	0.37
SLF0732T-221M-N	220	20		1.05	0.29
SLF0732T-331M-N	330	20		1.67	0.22
SLF0732T-471M-N	470	20		2.05	0.20
SLF0732T-681M-N	680	20		3.15	0.16
SLF0732T-102M-N	1000	20		4.78	0.13

Note:

Rated Current: Value obtained when DC current flows and the initial value of inductance has fallen by 10%.

Test Equipment Inductance: HP4192A LF Impedance analyzer or equivalent (Test frequency: 1KHz/0.5V)

RDC: CH502BC

ELECTRICAL CHARACTERISTICS SLF0745

PART NO.	INDUCTANCE (μ H)	TOLERANCE (\pm %)	TEST FREQUENCY (KHz)	DC RESISTANCE (Ω) \pm 20%	RATED CURRENT (A) Max.	ITEMP (A) Max.
SLF0745T-3R3M-N	3.3	20	1	0.02	2.50	2.30
SLF0745T-4R7M-N	4.7	20	1	0.03	2.00	2.10
SLF0745T-6R8M-N	6.8	20	1	0.039	1.70	1.74
SLF0745T-100M-N	10	20	1	0.036	1.30	1.78
SLF0745T-150M-N	15	20	1	0.052	1.10	1.53
SLF0745T-220M-N	22	20	1	0.061	0.90	1.34
SLF0745T-330M-N	33	20	1	0.096	0.82	1.09
SLF0745T-470M-N	47	20	1	0.125	0.75	0.92
SLF0745T-680M-N	68	20	1	0.175	0.60	0.77
SLF0745T-101M-N	100	20	1	0.25	0.50	0.65
SLF0745T-151M-N	150	20	1	0.34	0.40	0.55
SLF0745T-221M-N	220	20	1	0.52	0.33	0.45
SLF0745T-331M-N	330	20	1	0.74	0.25	0.37
SLF0745T-471M-N	470	20	1	1.05	0.22	0.31
SLF0745T-681M-N	680	20	1	1.48	0.20	0.27
SLF0745T-102M-N	1000	20	1	2.28	0.14	0.25

Note:

Rated Current: Value obtained when DC current flows and the initial value of inductance has fallen by 10%.

Itemp Current: Value obtained when current flows and the temperature has risen to 20 °C.

Test Equipment Inductance: HP4192A LF Impedance analyzer or equivalent (Test frequency: 1KHz/0.5V)

RDC: CH502BC

ELECTRICAL CHARACTERISTICS SLF1045

PART NO.	INDUCTANCE (μ H)	TOLERANCE (\pm %)	TEST FREQUENCY (KHz)	DC RESISTANCE (Ω) \pm 20%	RATED CURRENT (A) Max.	ITEMP (A) Max.
SLF1045T-100M-N	10	20	1	0.0364	3.00	2.50
SLF1045T-150M-N	15	20	1	0.0472	2.40	2.20
SLF1045T-220M-N	22	20	1	0.0591	2.10	1.90
SLF1045T-330M-N	33	20	1	0.0815	1.60	1.70
SLF1045T-470M-N	47	20	1	0.10	1.40	1.50
SLF1045T-680M-N	68	20	1	0.14	1.20	1.30
SLF1045T-101M-N	100	20	1	0.20	1.00	1.10
SLF1045T-151M-N	150	20	1	0.35	0.79	0.81
SLF1045T-221M-N	220	20	1	0.47	0.65	0.70
SLF1045T-331M-N	330	20	1	0.68	0.54	0.58
SLF1045T-471M-N	470	20	1	1.03	0.47	0.47
SLF1045T-681M-N	680	20	1	1.60	0.38	0.38
SLF1045T-102M-N	1000	20	1	2.80	0.32	0.29
SLF1045T-152M-N	1500	20	1	3.40	0.22	0.26

Note:

Rated Current: Value obtained when DC current flows and the initial value of inductance has fallen by 10%.

Itemp Current: Value obtained when current flows and the temperature has risen to 30 °C.

Test Equipment Inductance: HP4192A LF Impedance analyzer or equivalent (Test frequency: 1KHz/0.5V)

RDC: CH502BC



ELECTRICAL CHARACTERISTICS SLF1055

PART NO.	INDUCTANCE (μ H)	TOLERANCE (\pm %)	TEST FREQUENCY (KHz)	DC RESISTANCE (Ω) \pm 20%	RATED CURRENT (A) Max.
SLF1055T-100M-N	10	20	1	40	3.5
SLF1055T-330M-N	33	20	1	85	2.1

Note:

Rated Current: Value obtained when DC current flows and the initial value of inductance has fallen by 15%.

Test Equipment Inductance: HP4192A LF Impedance analyzer or equivalent (Test frequency: 1KHz/0.5V)

RDC: CH502BC

ELECTRICAL CHARACTERISTICS SLF1255

PART NO.	INDUCTANCE (μ H)	TOLERANCE (\pm %)	TEST FREQUENCY (KHz)	DC RESISTANCE (Ω) \pm 20%	RATED CURRENT (A) Max.	ITEMP (A) Max.
SLF1255T-6R0M-N	6	20	1	0.0164	3.60	4.90
SLF1255T-100M-N	10	20	1	0.0215	3.40	4.30
SLF1255T-150M-N	15	20	1	0.0259	2.80	3.90
SLF1255T-220M-N	22	20	1	0.0338	2.30	3.40
SLF1255T-330M-N	33	20	1	0.0415	1.90	3.10
SLF1255T-470M-N	47	20	1	0.0618	1.60	2.50
SLF1255T-680M-N	68	20	1	0.0832	1.30	2.20
SLF1255T-101M-N	100	20	1	0.117	1.10	1.80
SLF1255T-151M-N	150	20	1	0.190	0.88	1.40
SLF1255T-221M-N	220	20	1	0.270	0.72	1.20
SLF1255T-331M-N	330	20	1	0.410	0.59	1.00
SLF1255T-471M-N	470	20	1	0.520	0.49	0.88
SLF1255T-681M-N	680	20	1	0.760	0.43	0.73
SLF1255T-102M-N	1000	20	1	1.120	0.34	0.60
SLF1255T-152M-N	1500	20	1	1.730	0.29	0.48

Note:

Rated Current: Value obtained when DC current flows and the initial value of inductance has fallen by 10%.

Itemp Current: Value obtained when current flows and the temperature has risen to 30 °C.

Test Equipment Inductance: HP4192A LF Impedance analyzer or equivalent (Test frequency: 1KHz/0.5V)

RDC: CH502BC

ELECTRICAL CHARACTERISTICS SLF1265

PART NO.	INDUCTANCE (μ H)	TOLERANCE (\pm %)	TEST FREQUENCY (KHz)	DC RESISTANCE (Ω) \pm 20%	RATED CURRENT (A) Max.	ITEMP (A) Max.
SLF1265T-2R0T-N	2.0	30	I	0.0117	10	6.20
SLF1265T-4R2T-N	4.2	30	I	0.0150	7.3	5.50
SLF1265T-7R0T-N	7.0	30	I	0.0177	5.7	5.00
SLF1265T-100M-N	10	20	I	0.0202	5.0	4.80
SLF1265T-150M-N	15	20	I	0.0237	4.2	4.40
SLF1265T-220M-N	22	20	I	0.0316	3.5	3.80
SLF1265T-330M-N	33	20	I	0.0406	2.8	3.40
SLF1265T-470M-N	47	20	I	0.0578	2.4	2.80
SLF1265T-680M-N	68	20	I	0.0787	2.0	2.40
SLF1265T-101M-N	100	20	I	0.1230	1.6	1.90
SLF1265T-221M-N	220	20	I	0.2730	1.0	1.20

Note:

Rated Current: Value obtained when DC current flows and the initial value of inductance has fallen by 10%.

Itemp Current: Value obtained when current flows and the temperature has risen to 40 °C.

Test Equipment Inductance: HP4192A LF Impedance analyzer or equivalent (Test frequency: 1KHz/0.5V)

RDC: CH502BC

ELECTRICAL CHARACTERISTICS SLF1275

PART NO.	INDUCTANCE (μ H)	TOLERANCE (\pm %)	TEST FREQUENCY (KHz)	DC RESISTANCE (Ω) \pm 20%	RATED CURRENT (A) Max.	ITEMP (A) Max.
SLF1275T-1R2T-N	1.2	30	I	0.0069	13	8.20
SLF1275T-2R7T-N	2.7	30	I	0.0094	10	7.00
SLF1275T-3R9T-N	3.9	30	I	0.0104	9.0	6.70
SLF1275T-5R6T-N	5.6	30	I	0.0116	7.8	6.30
SLF1275T-6R8T-N	6.8	30	I	0.0131	7.2	5.90
SLF1275T-100M-N	10	20	I	0.0156	5.5	5.40
SLF1275T-150M-N	15	20	I	0.0184	4.7	5.00
SLF1275T-220M-N	22	20	I	0.0263	4.0	4.00
SLF1275T-330M-N	33	20	I	0.0395	3.2	3.40
SLF1275T-470M-N	47	20	I	0.0528	2.7	3.00
SLF1275T-680M-N	68	20	I	0.0778	2.0	2.40
SLF1275T-101M-N	100	20	I	0.1250	1.9	1.90
SLF1275T-151M-N	150	20	I	0.1750	1.5	1.60
SLF1275T-221M-N	220	20	I	0.2580	1.3	1.30

Note:

Rated Current: Value obtained when DC current flows and the initial value of inductance has fallen by 10%.

Itemp Current: Value obtained when current flows and the temperature has risen to 40 °C.

Test Equipment Inductance: HP4192A LF Impedance analyzer or equivalent (Test frequency: 1KHz/0.5V)

RDC: CH502BC



TAPE DIMENSIONS

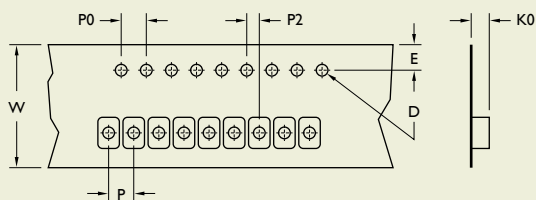

TAPE MATERIAL

Carrier Tape: Polystyrene

Carrier Tape: Polystyrene

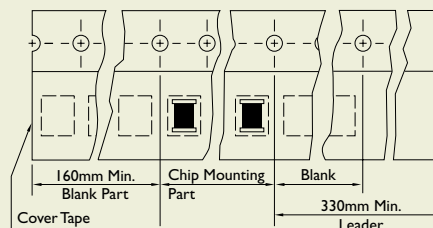

REEL DIMENSIONS

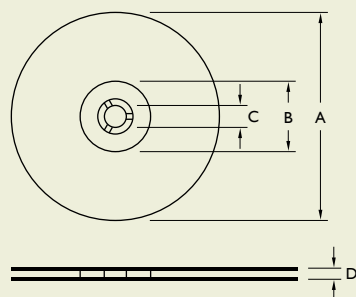

RECOMMENDED PATTERN

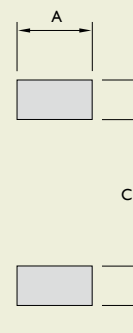

Dimensions: mm

TYPE	TAPE DIMENSIONS							RECOMMENDED PATTERN				REEL DIMENSIONS				QUANTITY/ REEL
	K0	D	E	W	P	P0	P2	A	B	C	D	A	B	C	D	
SLF0628	3.40	1.55	1.75	16	12	4	2	2.20	1.50	4.00	1.50	330	100	13	17.4	1,000
SLF0728	3.20	1.55	1.75	16	12	4	2	2.20	1.50	4.90	1.50	330	100	13	17.4	1,000
SLF0730	3.50	1.55	1.75	16	12	4	2	2.20	1.50	4.90	1.50	330	100	13	17.4	1,000
SLF0732	3.50	1.55	1.75	16	12	4	2	2.20	1.50	4.90	1.50	330	100	13	17.4	1,000
SLF0745	4.80	1.55	1.75	16	12	4	2	2.20	1.50	4.90	1.50	330	100	13	17.4	1,000
SLF1045	5.00	1.55	1.75	24	16	4	2	3.20	2.50	5.60	2.50	330	100	13	24.4	500
SLF1055	5.00	1.55	1.75	24	16	4	2	3.20	2.50	5.60	2.50	330	100	13	24.4	500
SLF1255	6.00	1.55	1.75	24	16	4	2	3.20	2.50	5.60	2.50	330	100	13	24.4	500
SLF1265	7.00	1.55	1.75	24	16	4	2	3.20	2.50	8.60	2.50	330	100	13	24.4	500
SLF1275	8.20	1.55	1.75	24	16	4	2	3.20	2.50	8.60	2.50	330	100	13	24.4	350

SCDA Series

SMD Power Inductors

APPLICATIONS

Power Supply for VTRs

OA Equipment

LCD Televisions

Notebook PCs

OUTLINE

Various high power surface mountable type inductors are superior to high saturation.

FEATURES

Available in magnetically shielded

Low DC resistance

Suitable for large currents

Ideal for a variety of DC-DC converter inductor applications.

Available on tape and reel for auto surface mounting.

SHAPES AND DIMENSIONS

TYPE	A	B	C
SCDA2D12	3.0 ± 0.2	1.2 ⁺⁰	0.5
SCDA2D15	3.0 ± 0.2	1.5 ⁺⁰	0.5
SCDA2D18	3.0 ± 0.2	1.8 ⁺⁰	0.5

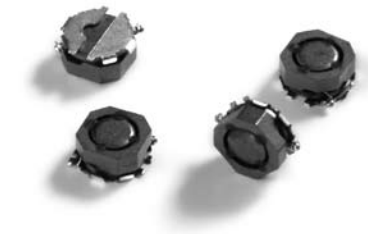

PRODUCT IDENTIFICATION

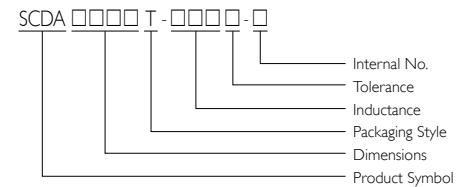

■ Packaging: T = Tape and Reel

■ Internal No.: N = Lead-Free

Unit: mm

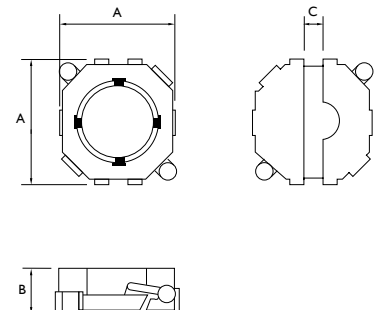



ELECTRICAL CHARACTERISTICS

STAMP	INDUCTANCE (μH)	DC RESISTANCE ($\text{m}\Omega$) Max. (Typ.)			IDC (A)		
		SCDA2D12	SCDA2D15	SCDA2D18	SCDA2D12	SCDA2D15	SCDA2D18
1R2T	1.2	120 (90)			1.20		
1R5T	1.5		140 (105)			1.30	
2R2T	2.2	180 (140)	160 (125)	150 (117)	0.85	1.10	1.30
3R3T	3.3	260 (200)	190 (145)	195 (150)	0.72	1.00	1.10
4R7T	4.7	390 (300)	260 (200)	220 (170)	0.53	0.85	0.85
5R6T	5.6	410 (320)	280 (230)	280 (216)	0.50	0.72	0.80
6R8T	6.8	600 (460)	390 (300)	320 (244)	0.48	0.65	0.75
8R2T	8.2	670 (520)	430 (350)	340 (280)	0.45	0.60	0.70
100M	10	750 (580)	480 (400)	480 (370)	0.40	0.53	0.60
120M	12		625 (480)	520 (400)		0.45	0.55
150M	15		800 (620)	580 (450)		0.43	0.50
180M	18		1040 (800)	780 (605)		0.38	0.40
220M	22		1170 (900)	890 (775)		0.33	0.32
270M	27			1020 (800)			0.30
330M	33			1360 (1050)			0.28
390M	39			1480 (1145)			0.25
470M	47			1700 (1315)			0.23

Note:

Inductance Tested at 100 KHz, 1 Vrms

Tolerance: M = $\pm 20\%$, T = $\pm 30\%$,

Tolerance of Inductance: SCDA2D12 1.2 μH to 8.2 μH $\pm 30\%$, 10 μH $\pm 20\%$

SCDA2D18 2.2 μH to 8.2 μH $\pm 30\%$, 10 μH to 47 μH $\pm 20\%$

SCDA2D15 1.5 μH to 8.2 μH $\pm 30\%$, 10 μH to 22 μH $\pm 20\%$

Test Instruments: L- HP4284A, RDC- CHEN HWA 502, IDC- HP4284+42841A

IDC: The current when the inductance decreases to 65%

TAPE DIMENSIONS

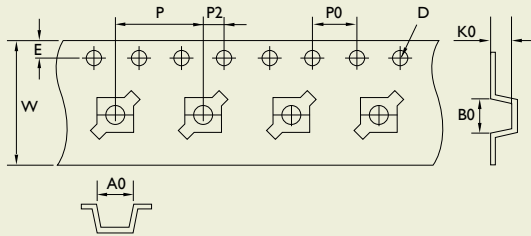

TAPE MATERIAL

Carrier Tape: Polystyrene

Cover Tape: Polyethylene

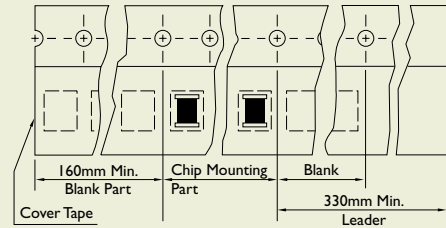

REEL DIMENSIONS

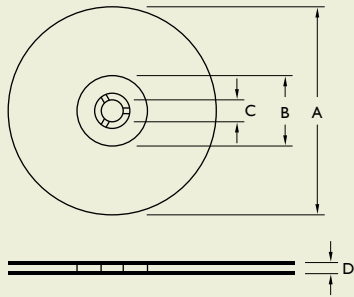

RECOMMENDED PATTERN

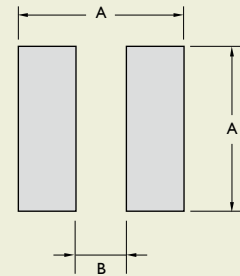

Dimensions: mm

TYPE	TAPE DIMENSIONS									RECOMMENDED REEL DIMENSIONS				QUANTITY/ REEL		
	A0	B0	K0	D	E	W	P	P0	P2	A	B	A	B		C	D
SCDA2D12	3.30	3.30	1.40	1.56	1.75	12	8	4	2	3.2	1.0	380	100	13	12	3,000
SCDA2D15	3.30	3.30	1.60	1.56	1.75	12	8	4	2	3.2	1.0	380	100	13	12	3,000
SCDA2D18	3.30	3.30	1.90	1.56	1.75	12	8	4	2	3.2	1.0	380	100	13	12	3,000

SMD Power Inductors

STD Series



PRODUCT IDENTIFICATION

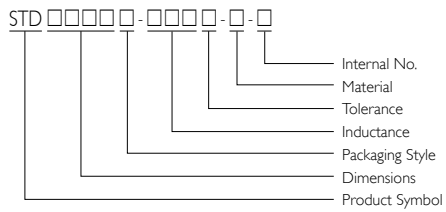

- Packaging: T = Tape and Reel
- Internal No.: N = Lead-Free

SHAPES AND DIMENSIONS

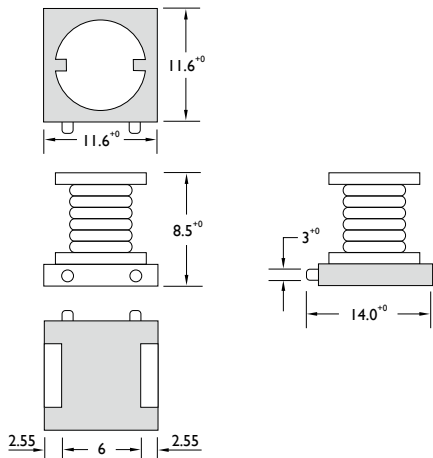

APPLICATIONS

Power Supply, Power Amplifiers

Switching Regulators

OUTLINE

Yageo SMD power inductors, STD Series, are best-designed noise / EMI / RFI filters for surface mount applications.

These components contain tremendous electrode straight, solder heat resistance and outstanding solderability.

They are specially designed for flow, reflow and wave soldering required for surface mounting applications.

FEATURES

For high current applications

Specially designed for high density surface applications.

Ideal for solder flow, reflow and wave soldering applications.

ELECTRICAL CHARACTERISTICS

PART NO.	INDUCTANCE (μ H)	TOLERANCE (\pm %)	DC RESISTANCE (Ω) Max.	RATED CURRENT (A)
STD1109T-100M-B-N	10	20	0.06	3.50
STD1109T-120M-B-N	12	20	0.07	3.40
STD1109T-150M-B-N	15	20	0.08	3.10
STD1109T-180M-B-N	18	20	0.09	3.00
STD1109T-220M-B-N	22	20	0.10	2.60
STD1109T-270M-B-N	27	20	0.11	2.40
STD1109T-330M-B-N	33	20	0.12	2.30
STD1109T-390M-B-N	39	20	0.14	2.10
STD1109T-470M-B-N	47	20	0.17	1.95
STD1109T-560M-B-N	56	20	0.19	1.85
STD1109T-680M-B-N	68	20	0.22	1.65
STD1109T-820M-B-N	82	20	0.25	1.50
STD1109T-101M-B-N	100	20	0.35	1.40
STD1109T-121M-B-N	120	20	0.40	1.30
STD1109T-151M-B-N	150	20	0.47	1.20
STD1109T-181M-B-N	180	20	0.63	1.00
STD1109T-221M-B-N	220	20	0.73	0.95
STD1109T-271M-B-N	270	20	0.97	0.90
STD1109T-331M-B-N	330	20	1.15	0.80
STD1109T-391M-B-N	390	20	1.30	0.75
STD1109T-471M-B-N	470	20	1.48	0.65
STD1109T-561M-B-N	560	20	1.90	0.60
STD1109T-681M-B-N	680	20	2.45	0.50
STD1109T-821M-B-N	820	20	2.55	0.48
STD1109T-102M-B-N	1,000	20	3.00	0.46
STD1109T-122M-B-N	1,200	20	3.50	0.35

Note:

Inductance Tested at HP4263B or HP4192A 1KHz, 1 Volt

Test Instruments: CH1061A + CH301A RF Impedance or HP4284A + HP42841A for L, IDC

Digital Multimeter CH502BC for RDC



TAPE DIMENSIONS

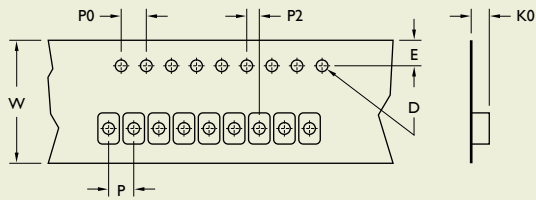

TAPE MATERIAL

Carrier Tape: Polystyrene

Cover Tape: Polyethylene

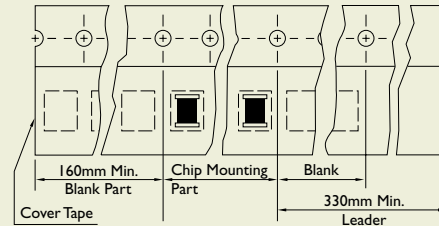

REEL DIMENSIONS

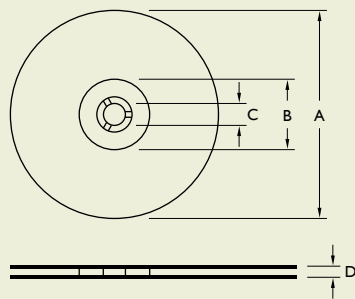

RECOMMENDED PATTERN

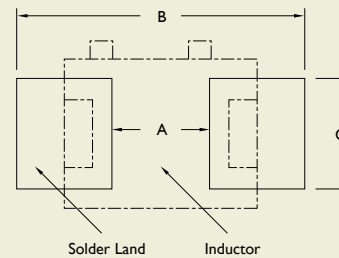

Dimensions: mm

TYPE	TAPE DIMENSIONS							RECOMMENDED PATTERN			REEL DIMENSIONS				QUANTITY/ REEL
	K0	D	E	W	P	P0	P2	A	B	C	A	B	C	D	
STD1109	8.70	1.55	1.75	24	20	4	2	3.6	12 ~ 14	5	330	100	13	24.4	400

SLH Series

SMD Power Inductors

APPLICATIONS

- High current POL converters
- Low profile, high current power supply
- Battery powered devices
- DC-DC converters in distributed power systems
- DC-DC converter for Field Programmable Gate Array (FPGA)
- Harsh environments including moisture, chemicals and salt spray

FEATURES

- Halogen Free products
- Shielded construction
- Lowest DCR/ μ H, in this package size
- Handle high transient current spikes without saturation
- No air-gap inside but filled with magnetic powder



PRODUCT IDENTIFICATION

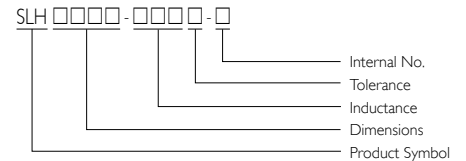

- Tolerance: J = $\pm 5\%$, K = $\pm 10\%$, L = $\pm 15\%$, M = $\pm 20\%$, P = $\pm 25\%$, N = $\pm 30\%$, Y = min
- Internal No.: N = Lead Free



SHAPES AND DIMENSIONS

Unit: mm

SLH0630/0650

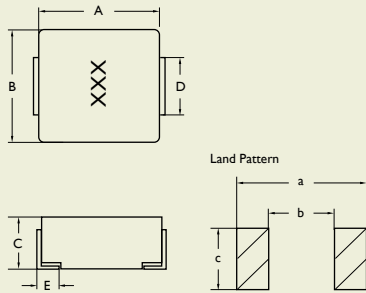

SLH1040/1235

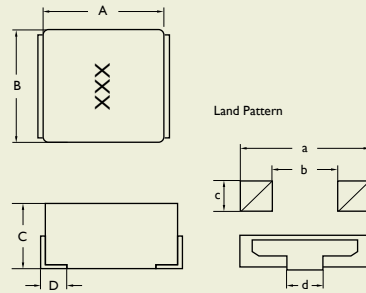

SLH1250/1265

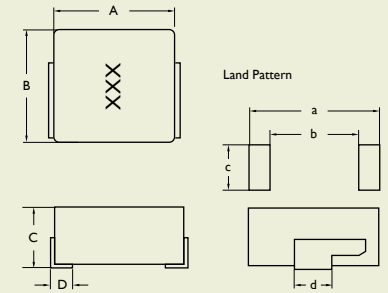

TYPE	A	B	C	D	E	a	b	c	d
SLH0630	6.86 ± 0.381	6.47 ± 0.254	3.0 ⁺⁰	3.18	1.27 ± 0.30	7.37	3.71	3.4	
SLH0650	6.86 ± 0.381	6.47 ± 0.254	5.0 ⁺⁰	3.18 ± 0.30	1.27 ± 0.30	7.37	3.71	3.4	
SLH1040	11.5 ⁺⁰	10.3 ⁺⁰	4.0 ⁺⁰	2.2 ± 0.30		13	6	4.0 ⁺⁰	3.0 ± 0.3
SLH1235	13.2 ± 0.38	12.9 ⁺⁰	3.5 ⁺⁰	2.3 ± 0.30		13.8	8.1	3.3	3.0 ± 0.3
SLH1250	13.2 ± 0.50	12.9 ⁺⁰	5.0 ⁺⁰	2.3 ± 0.30		13.76	7.87	5.0	4.7 ± 0.3
SLH1265	13.2 ± 0.50	12.9 ⁺⁰	6.5 ⁺⁰	2.3 ± 0.30		13.76	7.87	5.0	4.7 ± 0.3

ELECTRICAL CHARACTERISTICS SLH0630

PART NO.	INDUCTANCE (μH) $\pm 20\%$	DC RESISTANCE (m Ω)		Isat (A) Max.	I _{rms} (A) Max.
		Typical	Max.		
SLH0630-R10M-N	0.10	1.50	1.70	60.0	32.5
SLH0630-R15M-N	0.15	1.90	2.50	52.0	26.0
SLH0630-R20M-N	0.20	2.40	3.00	41.0	24.0
SLH0630-R22M-N	0.22	2.50	2.80	40.0	23.0
SLH0630-R33M-N	0.33	3.50	3.90	30.0	20.0
SLH0630-R47M-N	0.47	4.00	4.20	26.0	17.5
SLH0630-R68M-N	0.68	5.00	5.50	25.0	15.5
SLH0630-R82M-N	0.82	6.70	8.50	24.0	13.0
SLH0630-1R0M-N	1.00	9.00	10.0	22.0	11.0
SLH0630-1R5M-N	1.50	14.0	15.0	18.0	9.00
SLH0630-2R2M-N	2.20	18.0	20.0	14.0	8.00
SLH0630-3R3M-N	3.30	28.0	30.0	13.5	6.00
SLH0630-4R7M-N	4.70	37.0	40.0	10.0	5.50
SLH0630-6R8M-N	6.80	54.0	60.0	8.00	4.50
SLH0630-8R2M-N	8.20	64.0	68.0	7.50	4.00
SLH0630-100M-N	10.0	102	105	7.00	3.00

Note:

Inductance test frequency at 100 KHz

Isat: DC current at which the inductance drops 30% from its value without current

I_{rms}: The actual current when temperature of coil becomes $\Delta T = 40\text{ }^\circ\text{C}$

ELECTRICAL CHARACTERISTIC SLH0650

PART NO.	INDUCTANCE (μH) $\pm 20\%$	DC RESISTANCE ($\text{m}\Omega$)		Isat (A) Max.	I _{rms} (A) Max.
		TYPICAL	Max.		
SLH0650-R56M-N	0.56	3.40	3.60	12.0	20.0
SLH0650-R68M-N	0.68	4.20	4.50	11.5	18.0
SLH0650-R82M-N	0.82	4.60	4.90	13.0	16.5
SLH0650-1R0M-N	1.00	5.60	6.50	15.0	13.0
SLH0650-1R5M-N	1.50	8.60	9.00	12.0	12.0
SLH0650-2R2M-N	2.20	13.0	13.6	10.0	10.0
SLH0650-3R3M-N	3.30	19.9	20.9	8.00	8.00
SLH0650-4R7M-N	4.80	28.9	30.3	7.00	6.50
SLH0650-5R6M-N	5.60	32.7	34.4	7.00	6.00
SLH0650-6R8M-N	6.80	42.5	44.6	5.50	5.50
SLH0650-8R2M-N	8.20	43.5	45.6	5.50	5.50
SLH0650-100M-N	10.0	67.9	71.3	4.50	4.50

ELECTRICAL CHARACTERISTICS SLH1040

PART NO.	INDUCTANCE (μH) $\pm 20\%$	DC RESISTANCE ($\text{m}\Omega$)		Isat (A) Max.	I _{rms} (A) Max.
		TYPICAL	Max.		
SLH1040-R19M-N	0.19	0.88	0.95	90.0	40.0
SLH1040-R36M-N	0.36	1.30	1.40	60.0	31.5
SLH1040-R56M-N	0.56	1.70	1.80	49.0	27.5
SLH1040-1R0M-N	1.00	3.70	4.10	36.0	17.5
SLH1040-1R5M-N	1.50	5.30	5.80	27.5	15.0
SLH1040-2R2M-N	2.20	8.20	9.00	25.5	12.0
SLH1040-3R3M-N	3.30	10.8	11.8	18.6	10.0
SLH1040-4R7M-N	4.70	15.0	16.5	17.0	9.50
SLH1040-5R6M-N	5.60	17.6	19.3	16.0	8.50
SLH1040-6R8M-N	6.80	21.2	23.5	13.5	8.00
SLH1040-100M-N	10.0	33.2	36.5	12.0	6.80



ELECTRICAL CHARACTERISTIC SLHI250

PART NO.	INDUCTANCE (μH) $\pm 20\%$	DC RESISTANCE ($\text{m}\Omega$)		Isat (A) Max.	Irms (A) Max.
		TYPICAL	Max.		
SLHI250-R10M-N	0.10	0.53	0.60	118	55.0
SLHI250-R22M-N	0.22	0.64	0.80	110	51.0
SLHI250-R33M-N	0.33	0.85	1.10	80.0	42.0
SLHI250-R47M-N	0.47	1.10	1.30	65.0	38.0
SLHI250-R56M-N	0.56	1.30	1.50	55.0	36.0
SLHI250-R68M-N	0.68	1.50	1.70	54.0	34.0
SLHI250-R82M-N	0.82	2.00	2.30	53.0	31.0
SLHI250-1R0M-N	1.00	2.14	2.65	50.0	29.0
SLHI250-1R5M-N	1.50	3.40	4.10	48.0	23.0
SLHI250-2R2M-N	2.20	4.60	5.50	32.0	20.0
SLHI250-3R3M-N	3.30	7.70	9.20	32.0	15.0
SLHI250-4R7M-N	4.70	12.8	15.0	27.0	12.0
SLHI250-5R6M-N	5.60	14.0	16.5	22.0	11.5
SLHI250-6R8M-N	6.80	15.4	18.5	21.0	11.0
SLHI250-7R8M-N	7.80	17.2	20.5	18.0	10.0
SLHI250-8R2M-N	8.20	18.9	22.5	18.0	9.50
SLHI250-100M-N	10.0	21.4	25.5	16.0	9.00

Note:

Inductance test frequency at 100 KHz

Isat: DC current at which the inductance drops 30% from its value without current

Irms: The actual current when temperature of coil becomes $\Delta T = 40\text{ }^\circ\text{C}$

TAPE DIMENSIONS

Unit: mm

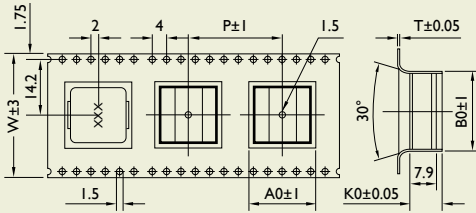

TYPE	A0	B0	K0	P	W	T
SLH0630	7.20	6.70	3.00	8.00	16.00	0.40
SLH0650	7.20	6.70	5.00	8.00	16.00	0.50
SLH1040	11.50	10.30	4.00	16.00	24.00	0.50
SLH1250	13.70	12.90	5.00	16.00	24.00	0.50

PACKAGING QUANTITY

TYPE	BULK	QUANTITY/REEL	CASKET/REEL	CASKET	QUANTITY/BOX
SLH0630	v	1,000	3	5	15,000
SLH0650	v	1,000	3	5	15,000
SLH1040	v	800	2	5	8,000
SLH1250	v	500	2	5	5,000

SMD Power Inductors

SFI Series



PRODUCT IDENTIFICATION

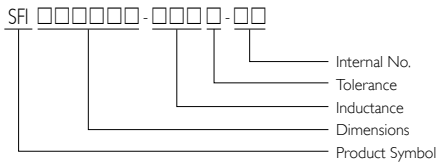

- Tolerance: J = ±5%, K = ±10%, L = ±15%, M = ±20%;
P = ±25%, N = ±30%
- Internal No.: HF = Halogen Free

SHAPES AND DIMENSIONS

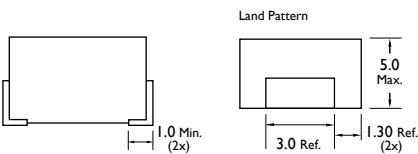
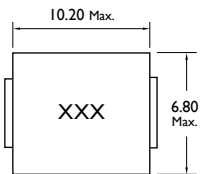

Dimensions: mm

APPLICATIONS

Voltage Regulator Modules (VRMs) for Servers, Microprocessors

High Frequency, High Current Switching Power Supplies

FEATURES

Halogen Free Products

Shielded Construction

Lowest DCR/μH

Handles High Transient Current Spikes without Saturation

ELECTRICAL CHARACTERISTICS

PART NO.	INDUCTANCE (μH)	TEST FREQUENCY (MHz)	DC RESISTANCE (mΩ) Max.	Isat (A) Max.	Irms (A) Max.
SFI100605-R10□-HF	0.10	I	0.65	64	40
SFI100605-R12□-HF	0.12	I	0.65	54	40
SFI100605-R15□-HF	0.15	I	0.65	42	40
SFI100605-R20□-HF	0.20	I	0.65	30	40

Note:

Isat: DC current at which the inductance drops 30% from its value without current

Irms: The actual current when temperature of coil becomes ΔT= 40°C

TAPE DIMENSIONS

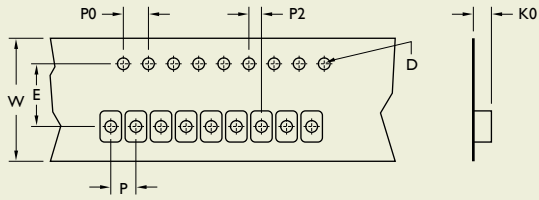

REEL DIMENSIONS

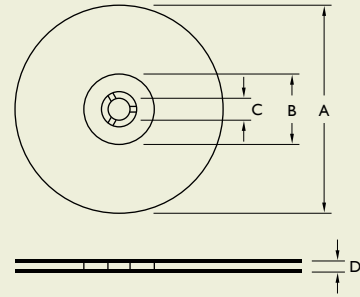

Dimensions: mm

TYPE	TAPE DIMENSIONS							REEL DIMENSIONS				PACKAGING QUANTITY			
	K0	D	E	W	P	P0	P2	A	B	C	D	QUANTITY/ REEL	CASKET/ REEL	CASKET	QUANTITY/ BOX
SFH100605	5.15	1.50	11.50	24	12	4	2	330	100	13.5	21.3	800	2	2	3,200

DIP Power Inductors

PMC Series



PRODUCT IDENTIFICATION

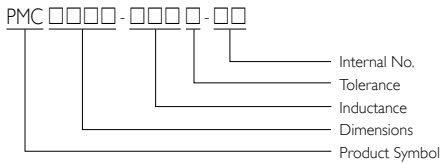

- Tolerance: J = ±5%, K = ±10%, L = ±15%, M = ±20%,
P = ±25%, N = ±30%, Y = min
- Internal No.: HF = Halogen Free

APPLICATIONS

Excellent for power lines used on DC-DC conversion applications i.e. power switching, personal computers and handheld devices.

FEATURES

- Halogen Free products
- Shielded construction
- Lowest DCR/μH, in this package size
- Handles high transient current spikes without saturation

SHAPES AND DIMENSIONS

Unit: mm

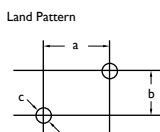
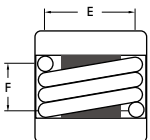
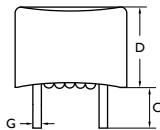
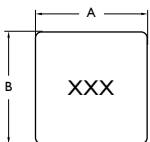

TYPE	A	B	C	D	E	F	G	a	b	c
PMC107	11.5 ⁺⁰	11.5 ⁺⁰	3.4 ± 0.5	8.6 ⁺⁰	8.50 ± 0.5	3.5 ± 0.5	1.3 ± 0.1	8.5	3.5	1.7
PMC109	11.5 ⁺⁰	11.5 ⁺⁰	3.4 ± 0.5	10 ⁺⁰	8.50 ± 0.5	3.5 ± 0.5	1.1 ± 0.1	8.5	3.5	1.5
PMC115	11.5 ⁺⁰	11.5 ⁺⁰	3.4 ± 0.5	15 ⁺⁰	8.50 ± 0.5	3.5 ± 0.5	1.4 ± 0.1	8.5	3.5	1.8
PMC127	14.0 ⁺⁰	14.0 ⁺⁰	3.4 ± 0.5	8.5 ⁺⁰	11.5 ± 0.5	6.5 ± 0.5	1.1 ± 0.1	11.5	6.5	1.5
PMC129	14.0 ⁺⁰	14.0 ⁺⁰	3.4 ± 0.5	10 ⁺⁰	11.5 ± 0.5	6.5 ± 0.5	1.1 ± 0.1	11.5	6.5	1.5

ELECTRICAL CHARACTERISTICS

PART NO.	INDUCTANCE (μ H)	TOLERANCE (\pm %)	TEST FREQUENCY (KHz)	DC RESISTANCE (m Ω) \pm 10%	Isat (A) Max.	Irms (A) Max.
PMC107-R25M-HF	0.25	20	100	0.56	40.0	36.0
PMC107-R40M-HF	0.40	20	100	0.61	40.0	36.0
PMC107-R50M-HF	0.50	20	100	0.93	40.0	37.0
PMC109-R47M-HF	0.47	20	100	1.10	35.0	31.5
PMC109-R50M-HF	0.50	20	100	0.97	35.0	31.5
PMC109-1R2M-HF	1.20	20	100	1.15	25.0	22.5
PMC109-2R2M-HF	2.20	20	100	3.05	20.0	18.0
PMC115-R70M-HF	0.70	20	100	1.12	40.0	36.0
PMC127-R60M-HF	0.60	20	100	0.81	40.0	36.0
PMC127-1R0M-HF	1.00	20	100	1.38	38.0	35.0
PMC127-1R2M-HF	1.20	20	100	1.75	32.0	30.0
PMC127-1R5M-HF	1.50	20	100	2.08	32.0	28.0
PMC127-2R2M-HF	2.20	20	100	2.81	28.0	34.0
PMC127-3R3M-HF	3.30	20	100	2.81	10.0	9.00
PMC129-R30M-HF	0.30	20	100	0.45	40.0	36.0
PMC129-R50M-HF	0.50	20	100	0.74	40.0	36.0
PMC129-R60M-HF	0.60	20	100	0.73	40.0	36.0
PMC129-R90M-HF	0.90	20	100	1.13	30.0	50.0
PMC129-1R0M-HF	1.00	20	100	1.48	30.0	27.0
PMC129-1R2M-HF	1.20	20	100	1.86	30.0	27.0
PMC129-1R5M-HF	1.50	20	100	2.13	25.0	21.5
PMC129-2R2M-HF	2.20	20	100	2.44	20.0	18.0
PMC129-3R3M-HF	3.30	20	100	2.96	15.0	13.5
PMC129-4R7M-HF	4.70	20	100	5.10	8.00	7.20



PLATE DIMENSIONS

Unit: mm

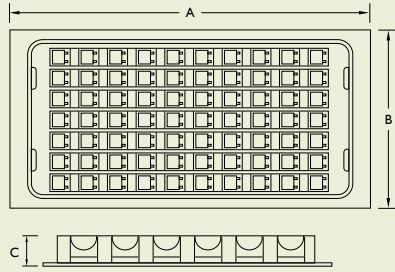

TYPE	A	B	C
PMC107	251	138	13.00
PMC109	251	138	13.00
PMC115	251	138	13.00
PMC127	251	138	16.00
PMC129	251	138	16.00

PACKAGING QUANTITY

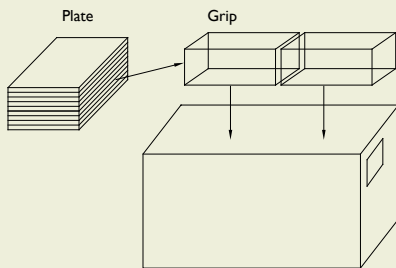

TYPE	BULK	QTY/PLATE	PLATE/GRIP	GRIP	BOX
PMC107	v	60	8	2	960
PMC109	v	60	8	2	960
PMC115	v	50	8	2	800
PMC127	v	60	5	2	600
PMC129	v	60	5	2	600

PMD Series

DIP Power Inductors

APPLICATIONS

Excellent for power lines used on DC-DC conversion applications i.e. power switching, personal computers and handheld devices.

FEATURES

Halogen Free products

Shielded construction

Lowest DCR/ μ H, in this package size

Handles high transient current spikes without saturation

SHAPES AND DIMENSIONS

TYPE	A	B	C	D	E	F	G	a	b	c
PMD0808	8.50 ⁺⁰	8.50 ⁺⁰	3.4 ± 0.5	9.7 ⁺⁰	6.5 ± 0.5	2.7 ± 0.5	1.2 ± 0.1	6.5	3.2	1.6
PMD1109	12.5 ⁺⁰	12.5 ⁺⁰	3.4 ± 0.5	10 ⁺⁰	8.5 ± 0.5	3.5 ± 0.5	1.1 ± 0.1	9.0	4.0	1.5
PMD9595	10.0 ⁺⁰	10.0 ⁺⁰	3.4 ± 0.5	10 ⁺⁰	6.0 ± 1.0	4.5 ± 1.0	1.2 ± 0.1	8.5	4.5	1.6



PRODUCT IDENTIFICATION

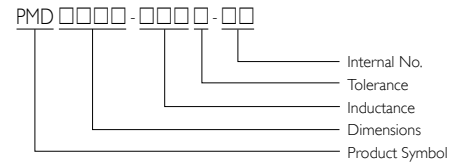

- Tolerance: J = ±5%, K = ±10%, L = ±15%, M = ±20%, P = ±25%, N = ±30%, Y = min
- Internal No.: HF = Halogen Free

Unit: mm

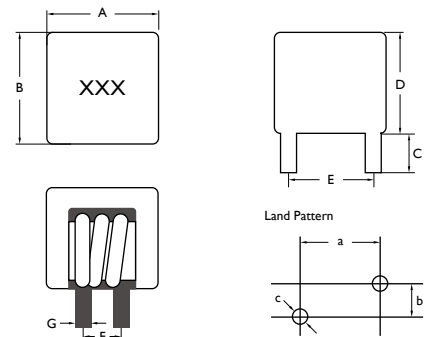



ELECTRICAL CHARACTERISTICS FERRITE CORES

PART NO.	INDUCTANCE (μ H)	TOLERANCE (\pm %)	TEST FREQUENCY (KHz)	DC RESISTANCE (m Ω) \pm 10%	Isat (A) Max.	Irms (A) Max.
PMD1109-R30M-HF	0.30	20	100	0.68	50.00	36.00
PMD1109-R43M-HF	0.43	20	100	0.70	40.00	35.00
PMD1109-R50M-HF	0.50	20	100	0.67	40.00	35.00
PMD1109-R56M-HF	0.56	20	100	0.69	30.00	27.00

ELECTRICAL CHARACTERISTICS IRON CORES

PART NO.	INDUCTANCE (μ H)	TOLERANCE (\pm %)	TEST FREQUENCY (KHz)	DC RESISTANCE (m Ω) \pm 10%	Isat (A) Max.	Irms (A) Max.
PMD0808-R47M-HF	0.47	20	200	1.50	25.00	20.00
PMD0808-R56M-HF	0.56	20	200	1.50	25.00	20.00
PMD1109-R47M-HF	0.47	20	200	1.10	40.00	35.00
PMD1109-R56M-HF	0.56	20	200	1.10	35.00	30.00
PMD1109-R68M-HF	0.68	20	200	1.70	30.00	25.00
PMD1109-1R2M-HF	1.20	20	200	4.00	21.00	18.00
PMD9595-R40M-HF	0.40	20	200	0.95	40.00	35.00
PMD9595-R47M-HF	0.47	20	200	1.50	27.00	25.00

Note:

Isat: DC current at which the inductance drops 20% from its value without current

Irms: The actual current when temperature of coil becomes $\Delta T = 40^\circ\text{C}$

PLATE DIMENSIONS

Unit: mm

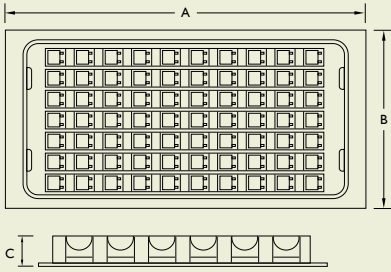

TYPE	A	B	C
PMD0808	251	143	12.00
PMD1109	251	138	13.00
PMD9595	251	138	13.00

PACKAGING QUANTITY

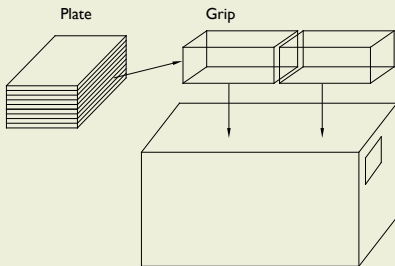

TYPE	BULK	QTY/PLATE	PLATE/GRIP	GRIP	BOX
PMD0808	v	80	10	2	1600
PMD1109	v	60	8	2	960
PMD9595	v	60	8	2	960

DIP Power Inductors

PMF Series



PRODUCT IDENTIFICATION

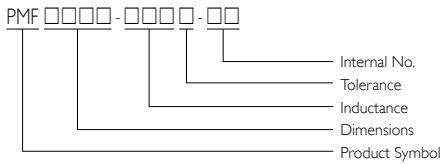

- Tolerance: J = ±5%, K = ±10%, L = ±15%, M = ±20%,
P = ±25%, N = ±30%, Y = min
- Internal No.: HF = Halogen Free

APPLICATIONS

Excellent for power lines used on DC-DC conversion applications i.e. power switching, personal computers and handheld devices.

FEATURES

- Halogen Free products
- Shielded construction
- Lowest DCR/μH, in this package size
- Handles high transient current spikes without saturation

SHAPES AND DIMENSIONS

Unit: mm

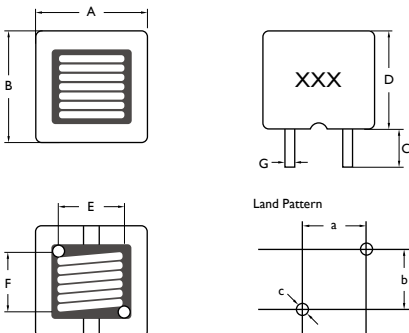

TYPE	A	B	C	D	E	F	G	a	b	c
PMF0806	8.2 ⁺⁰	8.2 ⁺⁰	3.5 ± 0.5	6.0 ⁺⁰	4.4 ± 0.5	4.4 ± 0.5	0.7 ± 0.1	4.9	4.4	1.0
PMF1008	11.7 ⁺⁰	9.7 ⁺⁰	3.5 ± 0.5	8.5 ⁺⁰	6.6 ± 0.5	4.2 ± 0.5	1.4 ± 0.1	7.1	4.2	1.8
PMF107	11.5 ⁺⁰	11.5 ⁺⁰	3.4 ± 0.5	8.0 ⁺⁰	6.5 ± 0.5	6.0 ± 0.5	1.1 ± 0.1	8.5	6.0	1.5
PMF109	11.5 ⁺⁰	11.5 ⁺⁰	3.4 ± 0.5	10.5 ⁺⁰	6.8 ± 0.5	6.8 ± 0.5	1.1 ± 0.1	9.6	6.8	1.5
PMF118	12.0 ⁺⁰	12.0 ⁺⁰	3.4 ± 0.5	9.0 ⁺⁰	6.3 ± 0.5	5.7 ± 0.5	1.5 ± 0.1	7.8	7.0	1.9
PMF129	14.0 ⁺⁰	13.0 ⁺⁰	3.4 ± 0.5	9.5 ⁺⁰	7.8 ± 0.5	7.0 ± 0.5	1.0 ± 0.1	7.8	7.0	1.4

ELECTRICAL CHARACTERISTICS FERRITE CORES

PART NO.	INDUCTANCE (μ H)	TOLERANCE (\pm %)	TEST FREQUENCY (KHz)	DC RESISTANCE (m Ω) \pm 10%	Isat (A) Max.	Irms (A) Max.
PMFI07-1R0M-HF	1.00	20	100	4.390	22.0	20.0
PMFI07-1R2M-HF	1.20	20	100	1.660	15.0	14.0
PMFI07-330M-HF	33.0	20	100	87.65	1.50	3.00
PMFI09-220M-HF	22.0	20	200	58.83	4.50	3.80
PMFI09-330M-HF	33.0	20	200	60.04	4.00	3.60
PMFI09-500M-HF	50.0	20	200	91.23	2.00	1.80
PMFI09-101M-HF	100	20	200	139.3	2.00	1.80
PMFI09-121M-HF	120	20	200	200.83	2.00	1.80
PMFI09-151M-HF	150	20	100	208.71	2.00	1.80
PMFI09-221M-HF	220	20	200	305.0	1.50	1.35
PMFI18-R30M-HF	0.30	20	100	0.760	30.0	50.0
PMFI29-1R0M-HF	1.00	20	100	0.990	35.0	27.0
PMFI29-1R2M-HF	1.20	20	100	1.350	35.0	31.5
PMFI29-3R3M-HF	3.30	20	100	4.040	22.0	21.0
PMFI29-101M-HF	100	20	100	124.0	3.00	2.70

Note:

Isat: DC current at which the inductance drops 20% from its value without current

Irms: The actual current when temperature of coil becomes $\Delta T = 40$ °C



ELECTRICAL CHARACTERISTICS IRON CORES

PART NO.	INDUCTANCE (μ H)	TOLERANCE (\pm %)	TEST FREQUENCY (KHz)	DC RESISTANCE (m Ω) \pm 10%	Isat (A) Max.	Irms (A) Max.
PMF0806-R47M-HF	0.47	20	100	1.90	38.00	22.00
PMF0806-R60M-HF	0.60	20	100	1.90	34.00	21.00
PMF0806-R80M-HF	0.80	20	100	2.90	27.00	17.00
PMF0806-1R0M-HF	1.00	20	100	4.30	22.00	14.00
PMFI008-R25M-HF	0.25	20	100	0.65	50.00	43.00
PMFI008-R30M-HF	0.30	20	100	0.65	45.00	43.00
PMFI 18-R47M-HF	0.47	20	100	0.80	50.00	38.00
PMFI 18-R60M-HF	0.60	20	100	0.80	50.00	38.00
PMFI 18-R80M-HF	0.80	20	100	1.30	45.00	31.00
PMFI 18-1R0M-HF	1.00	20	100	1.30	35.00	31.00
PMFI 18-1R5M-HF	1.50	20	100	1.80	25.00	26.00
PMFI 18-2R0M-HF	2.00	20	100	3.30	30.00	20.00
PMFI 18-3R3M-HF	3.30	20	100	6.30	25.00	14.00

Note:

Isat: DC current at which the inductance drops 20% from its value without current

Irms: The actual current when temperature of coil becomes $\Delta T = 40\text{ }^{\circ}\text{C}$

PLATE DIMENSIONS

Unit: mm

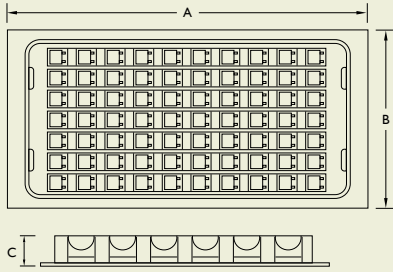

TYPE	A	B	C
PMF107	251	138	13.00
PMF109	251	138	13.00
PMF118	251	138	13.00
PMF129	250	138	17.00

PACKAGING QUANTITY

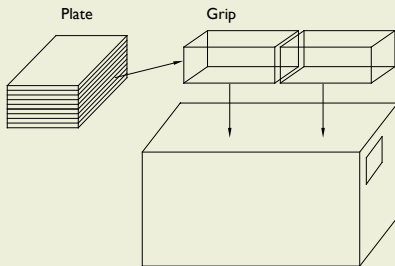

TYPE	BULK	QTY/PLATE	PLATE/GRIP	GRIP	BOX
PMF107	v	60	8	2	960
PMF109	v	60	5	2	600
PMF118	v	60	8	2	960
PMF129	v	60	8	2	960

DIP Power Inductors

NSF Series



PRODUCT IDENTIFICATION

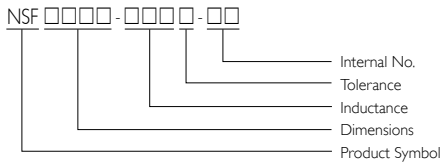

- Tolerance: J = $\pm 5\%$, K = $\pm 10\%$, L = $\pm 15\%$, M = $\pm 20\%$,
P = $\pm 25\%$, N = $\pm 30\%$, Y = min

- Internal No.: HF = Halogen Free

APPLICATIONS

Excellent for power lines used on DC-DC conversion applications i.e. power switching, personal computers and handheld devices.

FEATURES

Halogen Free products

Shielded construction

Lowest DCR/ μH , in this package size

Handles high transient current spikes without saturation

SHAPES AND DIMENSIONS

Unit: mm

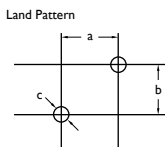
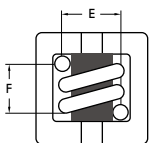
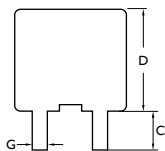
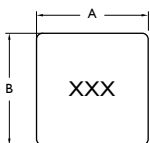

TYPE	A	B	C	D	E	F	G	a	b	c
NSF0806	8.2 ⁺⁰	8.2 ⁺⁰	3.5 \pm 0.5	7.0 ⁺⁰	4.4 \pm 0.5	4.5 \pm 0.5	0.7 \pm 0.1	4.9	4.5	1.0
NSF0808	8.2 ⁺⁰	8.6 ⁺⁰	3.5 \pm 0.5	9.5 ⁺⁰	5.5 \pm 0.5	4.0 \pm 0.5	0.55	5.5	4.5	0.95
NSF109	11.0 ⁺⁰	11.0 ⁺⁰	3.4 \pm 0.5	10.0 ⁺⁰	6.0 \pm 1.0	4.5 \pm 0.5	1.4 \pm 0.1	6.0	4.5	1.8
NSF118	11.5 ⁺⁰	11.5 ⁺⁰	3.4 \pm 0.5	10.5 ⁺⁰	6.8 \pm 0.5	6.8 \pm 0.5	1.0 \pm 0.1	6.8	6.8	1.4
NSF1210	11.7 ⁺⁰	11.7 ⁺⁰	3.4 \pm 0.5	10.5 ⁺⁰	7.0 \pm 0.5	6.0 \pm 0.5	1.5 \pm 0.1	7.0	6.0	1.9
NSF1310	12.7 ⁺⁰	12.7 ⁺⁰	3.4 \pm 0.5	10.5 ⁺⁰	7.3 \pm 0.5	6.3 \pm 0.5	1.5 \pm 0.1	7.3	6.3	1.9

ELECTRICAL CHARACTERISTICS FERRITE CORES

PART NO.	INDUCTANCE (μH)	TOLERANCE ($\pm\%$)	TEST FREQUENCY (KHz)	DC RESISTANCE ($\text{m}\Omega$) $\pm 10\%$	Isat (A) Max.	Irms (A) Max.
NSF0806-1R0M-HF	1.00	20	100	4.32	22.0	18.0
NSF0808-1R0M-HF	1.00	20	100	3.10	15.0	14.0
NSFI09-R25M-HF	0.25	20	100	1.02	40.0	36.0
NSFI09-R47M-HF	0.47	20	100	1.02	40.0	30.0
NSFI09-R50M-HF	0.50	20	100	0.78	30.0	30.0
NSFI09-R60M-HF	0.60	20	100	1.02	23.0	20.0
NSFI09-1R0M-HF	1.00	20	100	1.70	27.0	14.0
NSFI09-1R4M-HF	1.40	20	100	2.49	25.0	22.0
NSFI09-1R8M-HF	1.80	20	100	3.21	20.0	18.0
NSFI18-R36M-HF	0.36	20	100	0.88	60.0	54.0
NSFI18-R60M-HF	0.60	20	100	0.88	38.0	26.0
NSFI18-R68M-HF	0.68	20	100	0.88	33.0	23.0
NSFI18-1R2M-HF	1.20	20	100	1.65	30.0	20.0
NSFI210-R60M-HF	0.60	20	100	0.97	40.0	35.0
NSFI210-R68M-HF	0.68	20	100	0.80	40.0	35.0
NSFI210-101M-HF	100	20	100	140	3.00	2.70
NSFI210-121M-HF	120	20	100	150	2.00	1.80
NSFI210-221M-HF	220	20	100	350	2.00	1.80
NSFI310-R30M-HF	0.30	20	100	0.84	40.0	36.0
NSFI310-R60M-HF	0.60	20	100	0.84	40.0	36.0

Note:

Isat: DC current at which the inductance drops 20% from its value without current

Irms: The actual current when temperature of coil becomes $\Delta T = 40^\circ\text{C}$



ELECTRICAL CHARACTERISTICS IRON CORES

PART NO.	INDUCTANCE (μ H)	TOLERANCE (\pm %)	TEST FREQUENCY (KHz)	DC RESISTANCE (m Ω) \pm 10%	Isat (A) Max.	Irms (A) Max.
NSF0806-R47M-HF	0.47	20	100	1.90	38.00	22.00
NSF0806-R56M-HF	0.56	20	100	1.90	28.00	23.00
NSF0806-R60M-HF	0.60	20	100	1.90	34.00	21.00
NSF0806-R80M-HF	0.80	20	100	2.90	27.00	17.00
NSF0806-R82M-HF	0.82	20	100	2.90	23.00	18.00
NSF0806-1R0M-HF	1.00	20	100	4.30	22.00	14.00
NSF0806-1R2M-HF	1.20	20	100	4.30	21.00	15.00
NSF1008-R56M-HF	0.56	20	100	1.06	50.00	37.00
NSF1008-1R5M-HF	1.50	20	100	3.60	30.00	16.00
NSF118-R47M-HF	0.47	20	100	0.80	50.00	38.00
NSF118-R60M-HF	0.60	20	100	0.80	50.00	38.00
NSF118-R80M-HF	0.80	20	100	1.30	45.00	31.00
NSF118-1R0M-HF	1.00	20	100	1.30	35.00	31.00
NSF118-1R5M-HF	1.50	20	100	1.80	25.00	26.00
NSF118-2R0M-HF	2.00	20	100	3.30	30.00	20.00
NSF118-3R3M-HF	3.30	20	100	6.30	25.00	14.00
NSF1210-R47M-HF	0.47	20	100	0.80	50.00	41.00
NSF1210-R60M-HF	0.60	20	100	0.80	50.00	41.00
NSF1210-R68M-HF	0.68	20	100	0.80	40.00	35.00
NSF1210-R80M-HF	0.80	20	100	1.30	45.00	33.00
NSF1210-1R0M-HF	1.00	20	100	1.30	35.00	32.00
NSF1210-1R1M-HF	1.10	20	100	1.30	30.00	25.00
NSF1210-1R5M-HF	1.50	20	100	1.80	25.00	27.00
NSF1210-2R0M-HF	2.00	20	100	3.30	35.00	20.00
NSF1210-3R3M-HF	3.30	20	100	6.30	25.00	14.00
NSF1310-R47M-HF	0.47	20	100	0.75	50.00	40.00
NSF1310-R60M-HF	0.60	20	100	0.75	50.00	40.00
NSF1310-R80M-HF	0.80	20	100	0.75	50.00	39.00
NSF1310-1R0M-HF	1.00	20	100	1.15	42.00	32.00
NSF1310-1R5M-HF	1.50	20	100	1.85	42.00	26.00
NSF1310-2R0M-HF	2.00	20	100	3.00	35.00	21.00
NSF1310-2R4M-HF	2.40	20	100	3.00	25.00	20.00
NSF1310-3R3M-HF	3.30	20	100	4.30	22.00	17.00

Note:

Isat: DC current at which the inductance drops 20% from its value without current

Irms: The actual current when temperature of coil becomes $\Delta T = 40^\circ\text{C}$

PLATE DIMENSIONS

Unit: mm

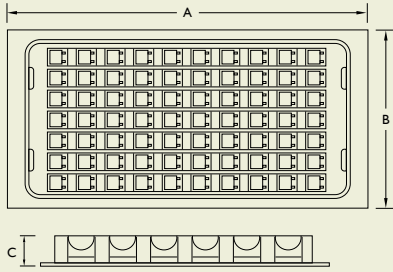

TYPE	A	B	C
NSF109	251	143	15.25
NSF118	251	138	13.00
NSF1210	251	138	13.00
NSF1310	251	138	13.00

PACKAGING QUANTITY

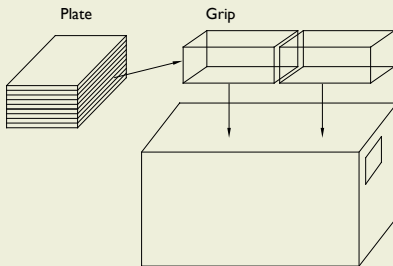

TYPE	BULK	QTY/PLATE	PLATE/GRIP	GRIP	BOX
NSF118	v	60	8	2	960
NSF1210	v	60	8	2	960
NSF1310	v	60	8	2	960

DIP Power Inductors

MC Series



PRODUCT IDENTIFICATION

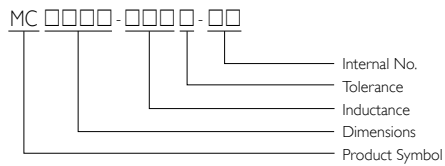

- Tolerance: J = ±5%, K = ±10%, L = ±15%, M = ±20%, P = ±25%, N = ±30%, Y = min
- Internal No.: HF = Halogen Free

APPLICATIONS

Excellent for power lines used on DC-DC conversion applications i.e. power switching, personal computers and handheld devices.

FEATURES

- Halogen Free products
- Shielded construction
- Lowest DCR/μH, in this package size
- Handles high transient current spikes without saturation
- No air-gap inside but filled with magnetic powder

SHAPES AND DIMENSIONS

Unit: mm

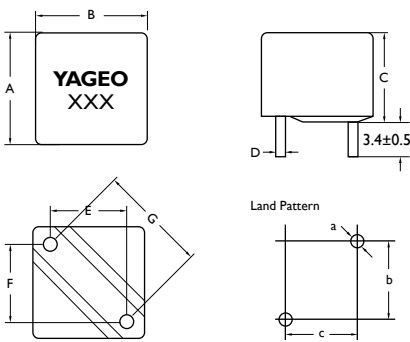

G size for 9.0 ± 0.5, customers can request the design

TYPE	A	B	C. Max	D	E	F	a	b	c
MC0809	8.5 ± 0.4	8.5 ± 0.4	9.9	1.2 ± 0.25	4.7 ± 0.5	4.7 ± 0.5	1.6	5.2	5.2
MC1208	10.2 ± 0.5	12.3 ± 0.5	7.5	1.4 ± 0.25	6.7 ± 0.5	6 ± 0.5	1.8	6.5	7.2
MC1209	10.2 ± 0.5	12.3 ± 0.5	9.5	1.7 ± 0.30	6.7 ± 0.5	6 ± 0.5	2.1	6.5	7.2
MC1210	10.2 ± 0.5	12.3 ± 0.5	10	1.5 ± 0.25	6.7 ± 0.5	6 ± 0.5	1.9	6.5	7.2
MC1211	10.2 ± 0.5	12.3 ± 0.5	11	1.7 ± 0.30	6.7 ± 0.5	6 ± 0.5	2.1	6.5	7.2

ELECTRICAL CHARACTERISTICS

PART NO.	INDUCTANCE (μH) $\pm 20\%$	DC RESISTANCE ($\text{m}\Omega$)		Isat (A) Max.	I _{rms} (A) Max.
		Typical	Max.		
MC1208-R22M-N	0.22	0.50	0.60	56.00	36.00
MC1209-R33M-N	0.33	0.70	0.80	48.00	31.00
MC1209-R39M-N	0.39	0.70	0.80	43.00	31.00
MC1209-R47M-N	0.47	0.65	0.75	50.00	36.00
MC1209-R56M-N	0.56	0.65	0.75	50.00	36.00
MC1210-R56M-N	0.56	0.90	1.00	38.00	28.00
MC1210-R68M-N	0.68	0.90	1.00	36.00	28.00
MC1210-R80M-N	0.80	1.25	1.45	34.00	24.00
MC1210-1R0M-N	1.00	1.75	2.00	32.00	20.00
MC1210-1R2M-N	1.20	1.20	1.36	40.00	26.00
MC1210-1R5M-N	1.50	3.00	3.50	30.00	16.00
MC1210-2R2M-N	2.20	4.30	5.00	24.00	13.60
MC1210-2R8M-N	2.80	5.60	6.40	20.00	12.30
MC1210-3R3M-N	3.30	6.80	7.70	16.00	11.20
MC1210-R47M-N	0.47	0.90	1.00	40.00	28.00
MC1210-4R7M-N	4.70	8.80	10.00	15.00	10.00
MC1211-R68M-N	0.68	0.78	0.90	48.00	34.00
MC1211-R80M-N	0.80	0.86	1.00	45.00	32.00
MC1211-R90M-N	0.90	0.86	1.00	45.00	32.00

Note:

Inductance test frequency at 100 KHz

Isat: DC current at which the inductance drops 30% from its value without current

I_{rms}: The actual current when temperature of coil becomes $\Delta T = 40\text{ }^\circ\text{C}$



PLATE DIMENSIONS

Unit: mm

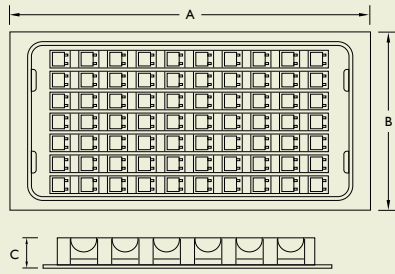

TYPE	A	B	C
MC1208	251	138	13.00
MC1209	251	138	13.00
MC1210	251	138	13.00
MC1211	251	138	13.00

PACKAGING QUANTITY

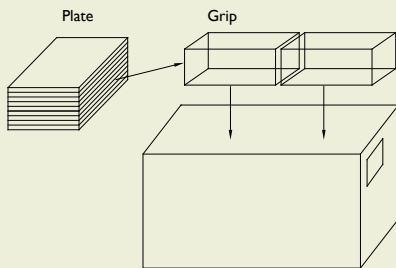

TYPE	BULK	QTY/PLATE	PLATE/GRIP	GRIP	BOX
MC1208	v	60	8	2	960
MC1209	v	60	8	2	960
MC1210	v	60	8	2	960
MC1211	v	60	8	2	960

SLM Series

DIP Power Inductors

APPLICATIONS

Televisions, VCRs and PC

DC-DC converters and other electronic equipments

FEATURES

Halogen Free Products

Unshield Construction

DIP Drum Inductor



PRODUCT IDENTIFICATION

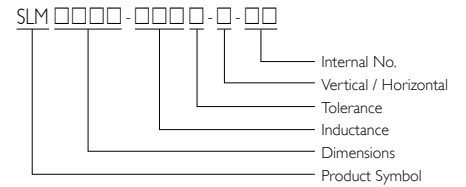

■ Tolerance: J = ±5%, K = ±10%, L = ±15%, M = ±20%,
P = ±25%, N = ±30%, Y = min

■ Internal No.: HF = Halogen Free

SHAPES AND DIMENSIONS

Unit: mm

TYPE	A	B	C	D	E
SLM0709	7.7	9.5	5.0 ± 1.0	3.5	∅ 0.60 ± 0.05
SLM0808	8.5 ± 0.3	8.3 ± 0.5	5.0 ± 1.0	5 +0.8/-0.5	∅ 0.60 ± 0.05
SLM1112	11.2 ± 0.3	12.2 ± 0.3	5.0 ± 1.0	5 +1.0/-0.5	∅ 0.65 ± 0.05

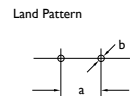
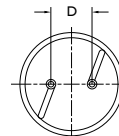
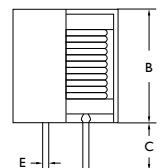
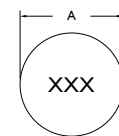



ELECTRICAL CHARACTERISTICS SLM0709

PART NO.	INDUCTANCE (μ H)	TOLERANCE (\pm %)	DC RESISTANCE (Ω) Max.	NOMINAL CURRENT (A) Max.
SLM0709-1R0M-□-HF	1.00	20.0	0.006	6.60
SLM0709-1R5M-□-HF	1.50	20.0	0.008	5.40
SLM0709-2R2M-□-HF	2.20	20.0	0.011	4.00
SLM0709-3R3M-□-HF	3.30	20.0	0.018	3.60
SLM0709-4R7M-□-HF	4.70	20.0	0.022	3.10
SLM0709-6R8M-□-HF	6.80	20.0	0.028	2.50
SLM0709-100K-□-HF	10.0	10.0	0.043	2.10
SLM0709-150K-□-HF	15.0	10.0	0.056	1.70
SLM0709-220K-□-HF	22.0	10.0	0.086	1.40
SLM0709-330K-□-HF	33.0	10.0	0.140	1.10
SLM0709-470K-□-HF	47.0	10.0	0.170	0.96
SLM0709-680K-□-HF	68.0	10.0	0.280	0.79
SLM0709-101K-□-HF	100	10.0	0.330	0.66
SLM0709-151K-□-HF	150	10.0	0.560	0.53
SLM0709-221K-□-HF	220	10.0	0.720	0.44
SLM0709-331K-□-HF	330	10.0	1.100	0.36
SLM0709-471K-□-HF	470	10.0	1.700	0.30
SLM0709-681K-□-HF	680	10.0	2.300	0.25
SLM0709-102K-□-HF	1,000	10.0	4.300	0.20
SLM0709-152K-□-HF	1,500	10.0	5.000	0.17

Note:

Inductance test frequency at 1 KHz

Isat: DC current at which the inductance drops 10% from its value without current

Irms: The actual current when temperature of coil becomes $\Delta T = 25\text{ }^{\circ}\text{C}$

ELECTRICAL CHARACTERISTICS SLM0808

PART NO.	INDUCTANCE (μH)	TOLERANCE ($\pm\%$)	Q Min.	TEST FREQUENCY L/Q (MHz) Min.	DC RESISTANCE (Ω) Max.	Isat (A) Max.	Irms (A) Max.
SLM0808-3R3M-□-HF	3.30	20.0	10	1K / 7.96M	0.017	4.50	3.80
SLM0808-4R7M-□-HF	4.70	20.0	10	1K / 7.96M	0.021	3.80	3.50
SLM0808-6R8M-□-HF	6.80	20.0	10	1K / 7.96M	0.025	3.20	3.10
SLM0808-100K-□-HF	10.0	10.0	20	1K / 2.52M	0.031	2.60	2.70
SLM0808-150K-□-HF	15.0	10.0	20	1K / 2.52M	0.042	2.10	2.40
SLM0808-220K-□-HF	22.0	10.0	20	1K / 2.52M	0.070	1.70	1.90
SLM0808-330K-□-HF	33.0	10.0	20	1K / 2.52M	0.092	1.40	1.50
SLM0808-470K-□-HF	47.0	10.0	20	1K / 2.52M	0.130	1.20	1.30
SLM0808-680K-□-HF	68.0	10.0	20	1K / 2.52M	0.160	1.00	1.10
SLM0808-101K-□-HF	100	10.0	20	1K / 796K	0.250	0.80	0.94
SLM0808-151K-□-HF	150	10.0	20	1K / 796K	0.400	0.67	0.73
SLM0808-221K-□-HF	220	10.0	15	1K / 796K	0.530	0.54	0.64
SLM0808-331K-□-HF	330	10.0	15	1K / 796K	0.780	0.45	0.52
SLM0808-471K-□-HF	470	10.0	15	1K / 796K	1.000	0.38	0.46
SLM0808-681K-□-HF	680	10.0	15	1K / 796K	1.500	0.32	0.37
SLM0808-102K-□-HF	1,000	10.0	30	1K / 252K	2.200	0.26	0.30
SLM0808-152K-□-HF	1,500	10.0	30	1K / 252K	3.500	0.21	0.25

Note:

Inductance test frequency at 1 KHz

Isat: DC current at which the inductance drops 10% from its value without current

Irms: The actual current when temperature of coil becomes $\Delta T = 25\text{ }^\circ\text{C}$



ELECTRICAL CHARACTERISTICS SLM112

PART NO.	INDUCTANCE (μ H)	TOLERANCE (\pm %)	Q Min.	TEST FREQUENCY L/Q (MHz) Min.	DC RESISTANCE (Ω) Max.	I _{sat} (A) Max.	I _{rms} (A) Max.
SLMI112-1R0M-□-HF	1.00	20.0	15	1K / 7.96M	0.058	14.0	7.70
SLMI112-2R2M-□-HF	2.20	20.0	15	1K / 7.96M	0.073	10.0	6.70
SLMI112-3R3M-□-HF	3.30	20.0	10	1K / 7.96M	0.010	8.80	5.90
SLMI112-4R7M-□-HF	4.70	20.0	10	1K / 7.96M	0.015	7.20	4.80
SLMI112-6R8M-□-HF	6.80	20.0	10	1K / 7.96M	0.016	6.10	4.60
SLMI112-100M-□-HF	10.0	20.0	20	1K / 2.52M	0.025	5.00	3.70
SLMI112-150M-□-HF	15.0	20.0	20	1K / 2.52M	0.029	4.20	3.40
SLMI112-220K-□-HF	22.0	10.0	20	1K / 2.52M	0.040	3.40	2.90
SLMI112-330K-□-HF	33.0	10.0	30	1K / 2.52M	0.062	2.80	2.30
SLMI112-470K-□-HF	47.0	10.0	30	1K / 2.52M	0.075	2.30	2.10
SLMI112-680K-□-HF	68.0	10.0	20	1K / 2.52M	0.130	1.90	1.60
SLMI112-101K-□-HF	100	10.0	20	1K / 796K	0.160	1.60	1.40
SLMI112-151K-□-HF	150	10.0	20	1K / 796K	0.260	1.30	1.10
SLMI112-221K-□-HF	220	10.0	20	1K / 796K	0.330	1.10	1.00
SLMI112-331K-□-HF	330	10.0	20	1K / 796K	0.520	0.88	0.82
SLMI112-471K-□-HF	470	10.0	10	1K / 796K	0.660	0.75	0.72
SLMI112-681K-□-HF	680	10.0	10	1K / 796K	1.100	0.61	0.56
SLMI112-102J-□-HF	1,000	5.0	20	1K / 796K	1.400	0.51	0.50
SLMI112-152J-□-HF	1,500	5.0	30	1K / 252K	2.400	0.43	0.38
SLMI112-222J-□-HF	2,200	5.0	20	1K / 252K	3.200	0.35	0.33
SLMI112-332J-□-HF	3,300	5.0	30	1K / 252K	4.900	0.28	0.26
SLMI112-472J-□-HF	4,700	5.0	30	1K / 252K	7.600	0.24	0.21
SLMI112-682J-□-HF	6,800	5.0	30	1K / 252K	0.450	9.8	0.20
SLMI112-103J-□-HF	10,000	5.0	30	1K / 79.6K	0.380	18	0.17
SLMI112-153J-□-HF	15,000	5.0	50	1K / 79.6K	0.290	24	0.13

Note:

Inductance test frequency at 1 KHz

I_{sat}: DC current at which the inductance drops 10% from its value without current

I_{rms}: The actual current when temperature of coil becomes $\Delta T = 25^\circ\text{C}$

SL Series

DIP Power Inductors

FEATURES

Lead-Free

Low Cost

Wide Range of Inductance

High Reliability



PRODUCT IDENTIFICATION

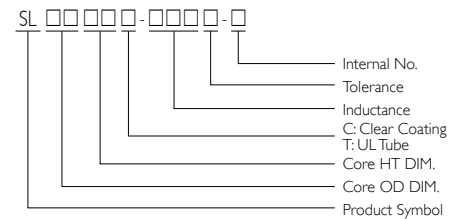

- Internal No.: N = Lead-Free
- Yageo uses UL tube on SL series to avoid damage when wave soldering.
- Customized specifications are also welcome.

SHAPES AND DIMENSIONS

Unit: mm

TYPE	A	B	C	D	E
SL0406	6 ⁺⁰	9 ⁺⁰	15 ⁻⁰	2.0 ± 1.0	0.5ø
SL0608	8 ⁺⁰	12 ⁺⁰	15 ⁻⁰	3.5 ± 1.5	0.65ø
SL1016	13 ⁺⁰	19 ⁺⁰	20 ⁻⁰	6.5 ± 1.5	0.8ø

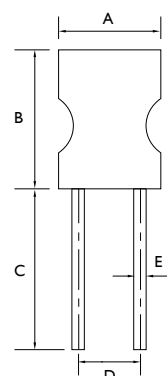



ELECTRICAL CHARACTERISTICS SL0406

PART NO.	INDUCTANCE (μ H)	TEST FREQUENCY (MHz)	Q Min.	DC RESISTANCE (Ω) Max.	IDC (mA)
SL0406-1R0K-N	1.0	7.96	50	0.15	300
SL0406-1R2K-N	1.2	7.96	50	0.15	300
SL0406-1R5K-N	1.5	7.96	55	0.20	300
SL0406-1R8K-N	1.8	7.96	70	0.20	300
SL0406-2R2K-N	2.2	7.96	75	0.25	300
SL0406-2R7K-N	2.7	7.96	80	0.25	300
SL0406-3R3K-N	3.3	7.96	80	0.25	300
SL0406-3R9K-N	3.9	7.96	80	0.30	300
SL0406-4R7K-N	4.7	7.96	75	0.30	300
SL0406-5R6K-N	5.6	7.96	75	0.35	300
SL0406-6R8K-N	6.8	7.96	70	0.35	300
SL0406-8R2K-N	8.2	7.96	70	0.35	300
SL0406-100K-N	10	2.52	80	0.60	300
SL0406-120K-N	12	2.52	80	0.65	200
SL0406-150K-N	15	2.52	80	0.75	200
SL0406-180K-N	18	2.52	75	0.85	200
SL0406-220K-N	22	2.52	75	1.00	200
SL0406-270K-N	27	2.52	75	1.20	200
SL0406-330K-N	33	2.52	75	1.30	200
SL0406-390K-N	39	2.52	70	1.50	200
SL0406-470K-N	47	2.52	70	1.60	200
SL0406-560K-N	56	2.52	65	1.65	200
SL0406-680K-N	68	2.52	60	1.80	200
SL0406-820K-N	82	2.52	55	1.85	200
SL0406-101K-N	100	0.796	80	2.00	200
SL0406-121K-N	120	0.796	80	2.50	100
SL0406-151K-N	150	0.796	80	3.00	100
SL0406-181K-N	180	0.796	75	3.50	100
SL0406-221K-N	220	0.796	75	4.00	100
SL0406-271K-N	270	0.796	70	5.00	100
SL0406-331K-N	330	0.796	70	6.00	50
SL0406-391K-N	390	0.796	70	6.50	50
SL0406-471K-N	470	0.796	70	7.50	50
SL0406-561K-N	560	0.796	70	8.00	50
SL0406-681K-N	680	0.796	70	8.50	50
SL0406-821K-N	820	0.796	70	9.50	50

Note:

Test Instruments: L/Q- HP4285+HP42851A

SRF- HP4287A

RDC- CHEN HWA502BC

IDC- CHEN HWA CHI061+301A

Customized specifications are also welcome.

ELECTRICAL CHARACTERISTICS SL0608

PART NO.	INDUCTANCE (mH)	TEST FREQUENCY (KHz)	Q Min.	DC RESISTANCE (Ω) Max.	IDC (mA)
SL0608□-102K-N	1.0	252	80	4.0	110
SL0608□-122K-N	1.2	252	80	4.7	95
SL0608□-152K-N	1.5	252	80	5.9	90
SL0608□-182K-N	1.8	252	80	6.0	80
SL0608□-222K-N	2.2	252	80	7.3	70
SL0608□-272K-N	2.7	252	80	9	65
SL0608□-332K-N	3.3	252	80	10	60
SL0608□-392K-N	3.9	252	80	11	55
SL0608□-472K-N	4.7	252	80	15	52
SL0608□-562K-N	5.6	252	80	16	50
SL0608□-682K-N	6.8	252	80	22	45
SL0608□-822K-N	8.2	252	80	25	40
SL0608□-103K-N	10	79.6	80	33	35
SL0608□-123K-N	12	79.6	80	53	32
SL0608□-153K-N	15	79.6	80	62	30
SL0608□-183K-N	18	79.6	80	68	28
SL0608□-223K-N	22	79.6	80	78	25
SL0608□-273K-N	27	79.6	80	90	22
SL0608□-333K-N	33	79.6	80	150	20
SL0608□-393K-N	39	79.6	80	160	16
SL0608□-473K-N	47	79.6	80	190	15

Note:

Test Instruments: L/Q- HP4285+HP4285 1A
RDC- CHEN HWA502BC

Customized specifications are also welcome.



ELECTRICAL CHARACTERISTICS SL1016

PART NO.	INDUCTANCE (μ H)	DC RESISTANCE (Ω) Max.	IDC (A)
SL1016□-4R7K-N	4.7	0.018	10.00
SL1016□-6R8K-N	6.8	0.020	10.00
SL1016□-8R2K-N	8.2	0.022	10.00
SL1016□-100K-N	10	0.027	7.60
SL1016□-120K-N	12	0.024	7.50
SL1016□-150K-N	15	0.031	6.50
SL1016□-180K-N	18	0.039	6.00
SL1016□-220K-N	22	0.039	5.40
SL1016□-330K-N	33	0.047	4.40
SL1016□-470K-N	47	0.053	3.80
SL1016□-560K-N	56	0.068	3.40
SL1016□-680K-N	68	0.078	3.00
SL1016□-101K-N	100	0.099	2.50
SL1016□-121K-N	120	0.128	2.00
SL1016□-151K-N	150	0.182	1.80
SL1016□-181K-N	180	0.195	1.60
SL1016□-221K-N	220	0.312	1.40
SL1016□-271K-N	270	0.32	1.30
SL1016□-331K-N	330	0.39	1.20
SL1016□-391K-N	390	0.40	1.10
SL1016□-471K-N	470	0.49	1.00
SL1016□-561K-N	560	0.52	0.95
SL1016□-681K-N	680	0.88	0.80
SL1016□-821K-N	820	0.89	0.75
SL1016□-102K-N	1,000	1.50	0.65
SL1016□-122K-N	1,200	1.15	0.60
SL1016□-152K-N	1,500	1.30	0.52
SL1016□-182K-N	1,800	1.90	0.50
SL1016□-222K-N	2,200	2.00	0.45
SL1016□-332K-N	3,300	4.60	0.35
SL1016□-472K-N	4,700	5.60	0.30
SL1016□-682K-N	6,800	7.00	0.25
SL1016□-752K-N	7,500	7.70	0.24
SL1016□-822K-N	8,200	10.40	0.23
SL1016□-103K-N	10,000	11.70	0.18
SL1016□-123K-N	12,000	13.80	0.16
SL1016□-153K-N	15,000	15.60	0.15
SL1016□-223K-N	22,000	23.40	0.10

Note:

Test Instruments: L- HP4263B at KHz/1V

RDC- CHEN HWA502BC

IDC- CHEN HWA CHI061+301A

Customized specifications are also welcome.

MB Series

DIP Power Inductors

FEATURES

Compact size, high performance, low cost

With Large current loads

Toroidal shape core reduces coils roar to an all-time low



PRODUCT IDENTIFICATION

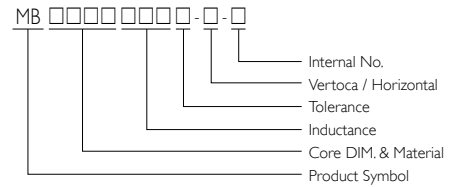

- Internal No.: N = Lead-Free
 - Customized specifications are also welcome.
-



SHAPES AND DIMENSIONS

Unit: mm

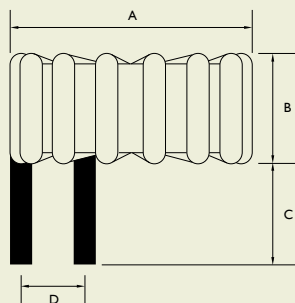

TYPE-HA	A Max.	B Max.	C	D
MB5026	15.5	8.0	6 ± 1	5 ± 1
MB5026B	15.5	9.5	6 ± 1	5 ± 1
MB5052	15.5	8.0	6 ± 1	5 ± 1
MB5052B	15.5	9.5	6 ± 1	5 ± 1
MB5018B	15.5	9.5	6 ± 1	5 ± 1
MB5018	15.5	8.0	6 ± 1	5 ± 1
MB6052	20.0	10.0	6 ± 1	6 ± 1
MB6018	20.0	10.0	6 ± 1	6 ± 1

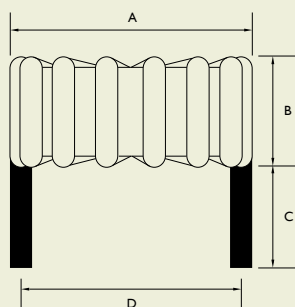

TYPE-HB	A Max.	B Max.	C	D
MB5026	18.0	10.0	6 ± 1	15 ± 1
MB5026B	18.0	11.5	6 ± 1	15 ± 1
MB5052	18.0	10.0	6 ± 1	15 ± 1
MB5052B	18.0	11.5	6 ± 1	15 ± 1
MB5018B	18.0	11.5	6 ± 1	15 ± 1
MB5018	18.0	10.0	6 ± 1	15 ± 1
MB6052	22.0	12.0	6 ± 1	17 ± 1
MB6018	22.0	12.0	6 ± 1	17 ± 1

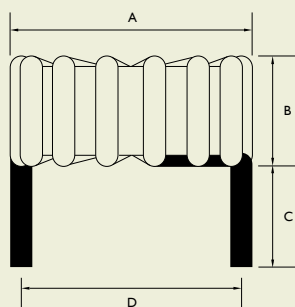

TYPE-HC	A Max.	B Max.	C	D
MB5026	15.5	8.0	6 ± 1	14 ± 1
MB5026B	15.5	9.5	6 ± 1	14 ± 1
MB5052	15.5	8.0	6 ± 1	14 ± 1
MB5052B	15.5	9.5	6 ± 1	14 ± 1
MB5018B	15.5	9.5	6 ± 1	14 ± 1
MB5018	15.5	8.0	6 ± 1	14 ± 1
MB6052	20.0	10.0	6 ± 1	16 ± 1
MB6018	20.0	10.0	6 ± 1	16 ± 1

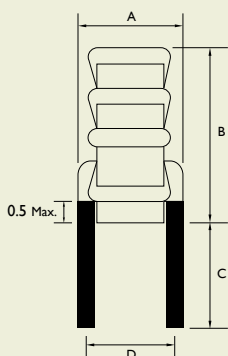

TYPE-V	A Max.	B Max.	C	D
MB5026	9.0	18.0	6 ± 1	7.0 ± 1
MB5026B	10.0	18.0	6 ± 1	8.5 ± 1
MB5052	9.0	18.0	6 ± 1	7.0 ± 1
MB5052B	10.0	18.0	6 ± 1	8.5 ± 1
MB5018B	10.0	18.0	6 ± 1	8.5 ± 1
MB5018	9.0	18.0	6 ± 1	7.0 ± 1
MB6052	11.0	21.0	6 ± 1	9.5 Ref.
MB6018	11.0	21.0	6 ± 1	9.5 Ref.

ELECTRICAL CHARACTERISTICS

STAMP	INDUCTANCE (μH)	DC RESISTANCE (Ω) Max.								PERMISSIBLE DC CURRENT (A) Max. / L (μH) Min. when current applied							
		5026	5026B	5052	5052B	5018	5018B	6052	6018	5026	5026B	5052	5052B	5018	5018B	6052	6018
1R0	1.0	6.0	5.0	6.0	5.0	6.0	5.0	4.0	4.0	15 / 0.8	15 / 0.8	15 / 0.8	15 / 0.8	15 / 0.8	15 / 0.8	20 / 0.8	20 / 0.8
1R2	1.2	6.0	5.0	6.0	5.0	6.0	5.0	4.0	4.0	15 / 1.0	15 / 1.0	15 / 1.0	15 / 1.0	15 / 1.0	15 / 1.0	20 / 1.0	20 / 1.0
1R5	1.5	6.0	6.0	6.0	6.0	6.0	6.0	4.0	4.0	12 / 1.2	15 / 1.2	12 / 1.2	15 / 1.2	15 / 1.2	15 / 1.2	20 / 1.2	20 / 1.2
1R8	1.8	7.0	6.0	7.0	6.0	7.0	6.0	4.0	4.0	12 / 1.5	12 / 1.5	12 / 1.5	12 / 1.5	12 / 1.5	12 / 1.5	15 / 1.5	15 / 1.5
2R0	2.0	7.0	6.0	7.0	6.0	7.0	6.0	4.0	4.0	11 / 1.6	12 / 1.6	11 / 1.6	12 / 1.6	12 / 1.6	12 / 1.6	15 / 1.6	15 / 1.6
2R2	2.2	7.0	7.0	7.0	7.0	7.0	7.0	4.0	4.0	11 / 1.7	12 / 1.7	11 / 1.7	12 / 1.7	12 / 1.7	12 / 1.7	15 / 1.7	15 / 1.7
2R5	2.5	8.0	7.0	8.0	7.0	8.0	7.0	5.0	5.0	10 / 2.0	10 / 2.0	10 / 2.0	10 / 2.0	10 / 2.0	10 / 2.0	15 / 2.0	15 / 2.0
2R7	2.7	8.0	7.0	8.0	7.0	8.0	7.0	5.0	5.0	10 / 2.2	10 / 2.2	10 / 2.2	10 / 2.2	10 / 2.2	10 / 2.2	12 / 2.2	12 / 2.2
3R0	3.0	8.0	7.0	8.0	7.0	8.0	7.0	5.0	5.0	9 / 2.4	10 / 2.4	9 / 2.4	10 / 2.4	10 / 2.4	10 / 2.4	12 / 2.4	12 / 2.4
3R3	3.3	8.0	7.0	8.0	7.0	8.0	7.0	5.0	5.0	9 / 2.7	9 / 2.7	9 / 2.7	9 / 2.7	9 / 2.7	9 / 2.7	12 / 2.7	12 / 2.7
3R5	3.5	9.0	8.0	9.0	8.0	9.0	8.0	5.0	5.0	8 / 2.8	9 / 2.8	8 / 2.8	9 / 2.8	9 / 2.8	9 / 2.8	12 / 2.8	12 / 2.8
3R9	3.9	9.0	8.0	9.0	8.0	9.0	8.0	5.0	5.0	8 / 3.0	9 / 3.3	8 / 3.0	9 / 3.3	9 / 3.3	9 / 3.3	10 / 3.0	10 / 3.0
4R0	4.0	9.0	8.0	9.0	8.0	9.0	8.0	5.0	5.0	7 / 3.2	8 / 3.2	7 / 3.2	8 / 3.2	8 / 3.2	8 / 3.2	10 / 3.2	10 / 3.2
4R5	4.5	9.0	9.0	9.0	9.0	9.0	9.0	5.0	5.0	7 / 3.6	8 / 3.6	7 / 3.6	8 / 3.6	8 / 3.6	8 / 3.6	10 / 3.6	10 / 3.6
4R7	4.7	10.0	9.0	10.0	9.0	10.0	9.0	6.0	6.0	6 / 3.8	8 / 3.8	6 / 3.8	8 / 3.8	8 / 3.8	8 / 3.8	9 / 3.8	9 / 3.8
5R0	5.0	10.0	9.0	10.0	9.0	10.0	9.0	6.0	6.0	6 / 4.0	7 / 4.0	6 / 4.0	7 / 4.0	7 / 4.0	7 / 4.0	9 / 4.0	9 / 4.0
5R5	5.5	10.0	9.0	10.0	9.0	10.0	9.0	6.0	6.0	5 / 4.4	7 / 4.4	5 / 4.4	7 / 4.4	7 / 4.4	7 / 4.4	8 / 4.4	8 / 4.4
6R0	6.0	10.0	9.0	10.0	9.0	10.0	9.0	6.0	6.0	5 / 4.8	7 / 4.8	5 / 4.8	7 / 4.8	7 / 4.8	7 / 4.8	8 / 4.8	8 / 4.8
6R5	6.5	11.0	9.0	11.0	9.0	11.0	9.0	6.0	6.0	5 / 5.0	6 / 5.2	5 / 5.0	6 / 5.2	6 / 5.2	6 / 5.2	8 / 5.2	8 / 5.2
7R0	7.0	11.0	10.0	11.0	10.0	11.0	10.0	6.0	6.0	4 / 5.6	6 / 5.6	4 / 5.6	6 / 5.6	6 / 5.6	6 / 5.6	7 / 5.6	7 / 5.6
7R5	7.5	11.0	10.0	11.0	10.0	11.0	10.0	6.0	6.0	4 / 6.1	5 / 6.1	4 / 6.1	5 / 6.1	5 / 6.1	5 / 6.1	7 / 6.1	7 / 6.1
8R0	8.0	12.0	10.0	12.0	10.0	12.0	10.0	7.0	7.0	3 / 6.4	5 / 6.4	3 / 6.4	5 / 6.4	5 / 6.4	5 / 6.4	7 / 6.4	7 / 6.4
8R5	8.5	12.0	11.0	12.0	11.0	12.0	11.0	7.0	7.0	3 / 6.8	4 / 6.8	3 / 6.8	4 / 6.8	4 / 6.8	4 / 6.8	6 / 6.8	6 / 6.8
9R0	9.0	12.0	11.0	12.0	11.0	12.0	11.0	7.0	7.0	3 / 7.2	4 / 7.2	3 / 7.2	4 / 7.2	4 / 7.2	4 / 7.2	6 / 7.2	6 / 7.2
9R5	9.5	12.0	12.0	12.0	12.0	12.0	12.0	7.0	7.0	2 / 7.6	3 / 7.6	2 / 7.6	3 / 7.6	3 / 7.6	3 / 7.6	6 / 7.6	6 / 7.6
100	10.0	12.0	12.0	12.0	12.0	12.0	12.0	7.0	7.0	2 / 8.0	3 / 8.0	2 / 8.0	3 / 8.0	3 / 8.0	3 / 8.0	6 / 8.0	6 / 8.0

Measuring Frequency of Inductance:
 MB5026 Series: 1 KHz
 MB5052 / 6052 Series: 100 KHz
 MB5018 / 6018 Series: 300 KHz

DIP Power Inductors

BC Series



PRODUCT IDENTIFICATION

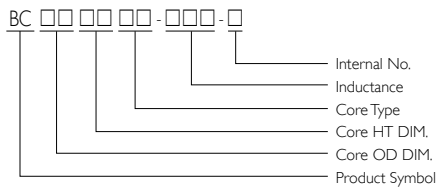

■ Internal No.: N = Lead-Free

■ Customized specifications are also welcome.

SHAPES AND DIMENSIONS

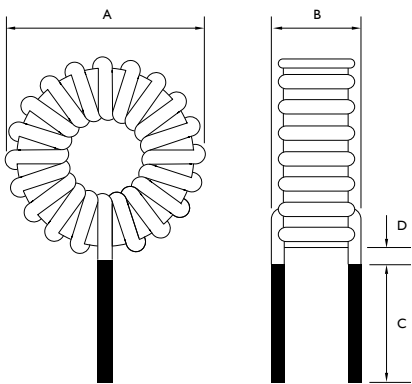

Dimensions: mm

FEATURES

Compact size, high performance, low cost

With Large current loads

Toroidal shape core reduces coils roar to an all-time low

ELECTRICAL CHARACTERISTICS

PART NO.	DIMENSIONS (mm)				WIRE DIA.	TURNS	INDUCTANCE (μ H) Typ.	RDC. (m Ω) Typ.
	A Max.	B Max.	C Max.	D Max.				
BC1005IR-330-N	12.0	7.0	25.0	3.0	0.4 ϕ	25	33	59
BC1104IR-300-N	13.5	7.5	25.0	3.0	0.4 ϕ	25	30	62
BC1305IR-330-N	15.5	8.5	25.0	3.0	0.4 ϕ	28	33	71
BC1306IR-300-N	17.0	9.5	25.0	3.0	0.6 ϕ	26	30	30
BC1506IR-330-N	19.0	10.0	25.0	3.0	0.6 ϕ	24	33	40
BC1806IR-390-N	21.0	10.0	25.0	3.0	0.6 ϕ	25	39	33
BC2006IR-430-N	25.0	11.0	25.0	3.0	0.8 ϕ	29	43	31
BC2310IR-960-N	27.0	13.5	25.0	3.0	0.8 ϕ	30	96	42
BC2711IR-121-N	32.0	17.0	25.0	3.0	1.0 ϕ	30	120	37
BC3311IR-141-N	40.0	17.0	25.0	3.0	1.0 ϕ	40	140	37

YAGEO - A GLOBAL COMPANY

ASIA

Beijing, China
Tel. +86 10 851 20810
Fax. +86 10 851 20200

Dongguan, China
Tel. +86 769 8772 0275
Fax. +86 769 8791 0053

Hong Kong, China
Tel. +852 2342 6833
Fax. +852 2342 6588

Suzhou, China
Tel. +86 512 6825 5568
Fax. +86 512 6825 5386

Saitama, Japan
Tel. +81 48 795 8953
Fax. +81 48 795 8954

Kyunggi-Do, Korea
Tel. +82 31 712 4797
Fax. +82 31 712 5866

Kuala Lumpur, Malaysia
Tel. +60 3 8063 8864
Fax. +60 3 8063 7376

Singapore
Tel. +65 6244 7800
Fax. +65 6244 4943

Taipei, Taiwan
Tel. +886 2 2917 7555
Fax. +886 2 2910 9056

EUROPE

Roermond, Benelux
Tel. +31 475 385 555
Fax. +31 475 385 589

Suresnes, France
Tel. +33 1 46 14 87 91
Fax. +33 1 46 14 87 92

Hamburg, Germany
Tel. +49 4121 870 189
Fax. +49 4121 870 271

Budapest, Hungary
Tel. +36 30 3777 441
Fax. +36 94 517 701

Milan, Italy
Tel. +39 02 6129 1017
Fax. +39 02 6601 7490

Moscow, Russian Federation
Tel. +7 916 625 92 38
Fax. +7 498 610 07 07

Barcelona, Spain
Tel. +34 93 212 3929
Fax. +39 02 6601 7490

Berkshire, UK
Tel. +44 7767 346 607
Fax. +44 208 781 1845

NORTH AMERICA

San Jose, U.S.A.
Tel. +1 408 240 6200
Fax. +1 408 240 6201

For more detailed and always up-to-date contact details of sales offices, distributors and representatives, please go to our web site at

www.yageo.com

© YAGEO Corporation

All rights are reserved. Reproduction in whole or in part is prohibited without the prior written consent of the copyright owner.
The information presented in this document does not form part of any quotation or contract, is believed to be accurate and reliable and may be changed without notice.
No liability will be accepted by the publisher for any consequence of its use. Publication thereof does not convey nor imply any license under patent or other industrial or intellectual property rights.