

MUN5111T1 Series

Bias Resistor Transistors

PNP Silicon Surface Mount Transistor with Monolithic Bias Resistor Network

This new series of digital transistors is designed to replace a single device and its external resistor bias network. The Bias Resistor Transistor (BRT) contains a single transistor with a monolithic bias network consisting of two resistors; a series base resistor and a base-emitter resistor. The BRT eliminates these individual components by integrating them into a single device. The use of a BRT can reduce both system cost and board space. The device is housed in the SC-70/SOT-323 package which is designed for low power surface mount applications.

Features

- Simplifies Circuit Design
- Reduces Board Space
- Reduces Component Count
- The SC-70/SOT-323 package can be soldered using wave or reflow. The modified gull-winged leads absorb thermal stress during soldering eliminating the possibility of damage to the die.
- Available in 8 mm embossed tape and reel – Use the Device Number to order the 7 inch/3000 unit reel. Replace “T1” with “T3” in the Device Number to order the 13 inch/10,000 unit reel.
- These Devices are Pb-Free, Halogen Free/BFR Free and are RoHS Compliant

MAXIMUM RATINGS ($T_A = 25^\circ\text{C}$ unless otherwise noted)

Rating	Symbol	Value	Unit
Collector-Base Voltage	V_{CB0}	50	Vdc
Collector-Emitter Voltage	V_{CEO}	50	Vdc
Collector Current	I_C	100	mAdc

Stresses exceeding Maximum Ratings may damage the device. Maximum Ratings are stress ratings only. Functional operation above the Recommended Operating Conditions is not implied. Extended exposure to stresses above the Recommended Operating Conditions may affect device reliability.

THERMAL CHARACTERISTICS

Characteristic	Symbol	Max	Unit
Total Device Dissipation $T_A = 25^\circ\text{C}$ Derate above 25°C	P_D	202 (Note 1) 310 (Note 2) 1.6 (Note 1) 2.5 (Note 2)	mW $^\circ\text{C/W}$
Thermal Resistance, Junction-to-Ambient	$R_{\theta JA}$	618 (Note 1) 403 (Note 2)	$^\circ\text{C/W}$
Thermal Resistance, Junction-to-Lead	$R_{\theta JL}$	280 (Note 1) 332 (Note 2)	$^\circ\text{C/W}$
Junction and Storage Temperature Range	T_J, T_{stg}	-55 to +150	$^\circ\text{C}$

1. FR-4 @ Minimum Pad
2. FR-4 @ 1.0 x 1.0 inch Pad



ON Semiconductor®

<http://onsemi.com>

PNP SILICON BIAS RESISTOR TRANSISTORS

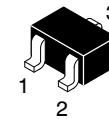
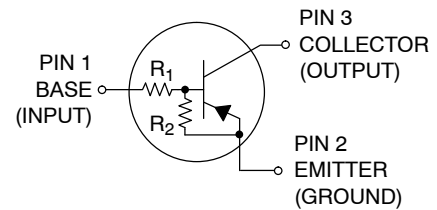

SC-70/SOT-323
CASE 419
STYLE 3

MARKING DIAGRAM

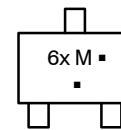

- 6x = Device Code
- M = Date Code*
- = Pb-Free Package

(Note: Microdot may be in either location)
*Date Code orientation may vary depending upon manufacturing location.

ORDERING INFORMATION

See specific ordering and shipping information in the package dimensions section on page 2 of this data sheet.

MUN511T1 Series

ORDERING INFORMATION AND RESISTOR VALUES

Device	Package	Marking	R1 (K)	R2 (K)	Shipping [†]
MUN5111T1G	SC-70/SOT-323 (Pb-Free)	6A	10	10	3000/Tape & Reel
MUN5112T1G	SC-70/SOT-323 (Pb-Free)	6B	22	22	3000/Tape & Reel
MUN5113T1G	SC-70/SOT-323 (Pb-Free)	6C	47	47	3000/Tape & Reel
MUN5113T3G	SC-70/SOT-323 (Pb-Free)	6C	47	47	10,000/Tape & Reel
MUN5113T1G	SC-70/SOT-323 (Pb-Free)	6C	47	47	3000/Tape & Reel
MUN5114T1G	SC-70/SOT-323 (Pb-Free)	6D	10	47	3000/Tape & Reel
MUN5115T1G (Note 3)	SC-70/SOT-323 (Pb-Free)	6E	10	∞	3000/Tape & Reel
MUN5116T1G (Note 3)	SC-70/SOT-323 (Pb-Free)	6F	4.7	∞	3000/Tape & Reel
MUN5130T1G (Note 3)	SC-70/SOT-323 (Pb-Free)	6G	1.0	1.0	3000/Tape & Reel
MUN5131T1G (Note 3)	SC-70/SOT-323 (Pb-Free)	6H	2.2	2.2	3000/Tape & Reel
MUN5132T1G (Note 3)	SC-70/SOT-323 (Pb-Free)	6J	4.7	4.7	3000/Tape & Reel
MUN5133T1G (Note 3)	SC-70/SOT-323 (Pb-Free)	6K	4.7	47	3000/Tape & Reel
MUN5134T1G (Note 3)	SC-70/SOT-323 (Pb-Free)	6L	22	47	3000/Tape & Reel
MUN5135T1G (Note 3)	SC-70/SOT-323 (Pb-Free)	6M	2.2	47	3000/Tape & Reel
MUN5136T1G	SC-70/SOT-323 (Pb-Free)	6N	100	100	3000/Tape & Reel
MUN5137T1G	SC-70/SOT-323 (Pb-Free)	6P	47	22	3000/Tape & Reel

[†]For information on tape and reel specifications, including part orientation and tape sizes, please refer to our Tape and Reel Packaging Specifications Brochure, BRD8011/D.

3. New devices. Updated curves to follow in subsequent data sheets.

MUN511T1 Series

ELECTRICAL CHARACTERISTICS (T_A = 25°C unless otherwise noted)

Characteristic	Symbol	Min	Typ	Max	Unit
OFF CHARACTERISTICS					
Collector-Base Cutoff Current (V _{CB} = 50 V, I _E = 0)	I _{CBO}	-	-	100	nAdc
Collector-Emitter Cutoff Current (V _{CE} = 50 V, I _B = 0)	I _{CEO}	-	-	500	nAdc
Emitter-Base Cutoff Current (V _{EB} = 6.0 V, I _C = 0)	I _{EBO}	-	-	0.5	mAdc
	MUN511T1	-	-	0.2	
	MUN5112T1	-	-	0.1	
	MUN5113T1	-	-	0.2	
	MUN5114T1	-	-	0.9	
	MUN5115T1	-	-	1.9	
	MUN5116T1	-	-	4.3	
	MUN5130T1	-	-	2.3	
	MUN5131T1	-	-	1.5	
	MUN5132T1	-	-	0.18	
	MUN5133T1	-	-	0.13	
	MUN5134T1	-	-	0.2	
	MUN5135T1	-	-	0.05	
	MUN5136T1	-	-	0.13	
	MUN5137T1	-	-		
Collector-Base Breakdown Voltage (I _C = 10 μA, I _E = 0)	V _{(BR)CBO}	50	-	-	Vdc
Collector-Emitter Breakdown Voltage (Note 4) (I _C = 2.0 mA, I _B = 0)	V _{(BR)CEO}	50	-	-	Vdc
ON CHARACTERISTICS (Note 4)					
DC Current Gain (V _{CE} = 10 V, I _C = 5.0 mA)	h _{FE}	35	60	-	
	MUN511T1	60	100	-	
	MUN5112T1	80	140	-	
	MUN5113T1	80	140	-	
	MUN5114T1	160	250	-	
	MUN5115T1	160	250	-	
	MUN5116T1	3.0	5.0	-	
	MUN5130T1	8.0	15	-	
	MUN5131T1	15	27	-	
	MUN5132T1	80	140	-	
	MUN5133T1	80	130	-	
	MUN5134T1	80	140	-	
	MUN5135T1	80	150	-	
	MUN5136T1	80	140	-	
	MUN5137T1	80	140	-	
Collector-Emitter Saturation Voltage (I _C = 10 mA, I _E = 0.3 mA) (I _C = 10 mA, I _B = 5 mA) MUN5130T1/MUN5131T1 (I _C = 10 mA, I _B = 1 mA) MUN5115T1/MUN5116T1/ MUN5132T1/MUN5133T1/MUN5134T1	V _{CE(sat)}	-	-	0.25	Vdc
Output Voltage (on) (V _{CC} = 5.0 V, V _B = 2.5 V, R _L = 1.0 kΩ)	V _{OL}	-	-	0.2	Vdc
	MUN511T1	-	-	0.2	
	MUN5112T1	-	-	0.2	
	MUN5114T1	-	-	0.2	
	MUN5115T1	-	-	0.2	
	MUN5116T1	-	-	0.2	
	MUN5130T1	-	-	0.2	
	MUN5131T1	-	-	0.2	
	MUN5132T1	-	-	0.2	
	MUN5133T1	-	-	0.2	
	MUN5134T1	-	-	0.2	
	MUN5135T1	-	-	0.2	
(V _{CC} = 5.0 V, V _B = 3.5 V, R _L = 1.0 kΩ)	MUN5113T1	-	-	0.2	
(V _{CC} = 5.0 V, V _B = 5.5 V, R _L = 1.0 kΩ)	MUN5136T1	-	-	0.2	
(V _{CC} = 5.0 V, V _B = 4.0 V, R _L = 1.0 kΩ)	MUN5137T1	-	-	0.2	

4. Pulse Test: Pulse Width < 300 μs, Duty Cycle < 2.0%

MUN511T1 Series

ELECTRICAL CHARACTERISTICS ($T_A = 25^\circ\text{C}$ unless otherwise noted) (Continued)

Characteristic	Symbol	Min	Typ	Max	Unit
Output Voltage (off) ($V_{CC} = 5.0\text{ V}$, $V_B = 0.5\text{ V}$, $R_L = 1.0\text{ k}\Omega$) ($V_{CC} = 5.0\text{ V}$, $V_B = 0.050\text{ V}$, $R_L = 1.0\text{ k}\Omega$) ($V_{CC} = 5.0\text{ V}$, $V_B = 0.25\text{ V}$, $R_L = 1.0\text{ k}\Omega$)	V_{OH}	4.9	-	-	Vdc
Input Resistor	R1				k Ω
MUN5111T1		7.0	10	13	
MUN5112T1		15.4	22	28.6	
MUN5113T1		32.9	47	61.1	
MUN5114T1		7.0	10	13	
MUN5115T1		7.0	10	13	
MUN5116T1		3.3	4.7	6.1	
MUN5130T1		0.7	1.0	1.3	
MUN5131T1		1.5	2.2	2.9	
MUN5132T1		3.3	4.7	6.1	
MUN5133T1		3.3	4.7	6.1	
MUN5134T1		15.4	22	28.6	
MUN5135T1		1.54	2.2	2.86	
MUN5136T1		70	100	130	
MUN5137T1		32.9	47	61.1	
Resistor Ratio	R_1/R_2				
MUN5111T1/MUN5112T1/MUN5113T1/MUN5136T1		0.8	1.0	1.2	
MUN5114T1		0.17	0.21	0.25	
MUN5115T1/MUN5116T1		-	-	-	
MUN5130T1/MUN5131T1/MUN5132T1		0.8	1.0	1.2	
MUN5133T1		0.055	0.1	0.185	
MUN5134T1		0.38	0.47	0.56	
MUN5135T1		0.038	0.047	0.056	
MUN5137T1		1.7	2.1	2.6	

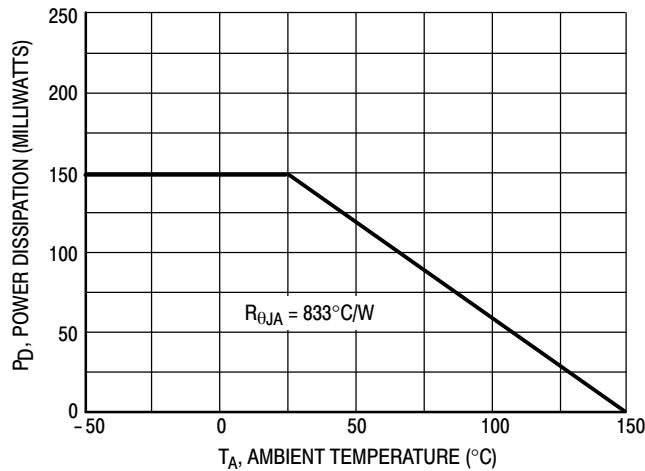

Figure 1. Derating Curve

MUN511T1 Series

TYPICAL ELECTRICAL CHARACTERISTICS – MUN511T1

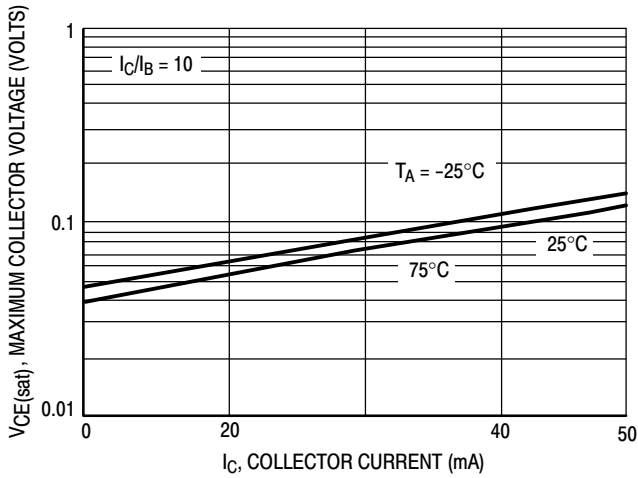

Figure 2. $V_{CE(sat)}$ versus I_C

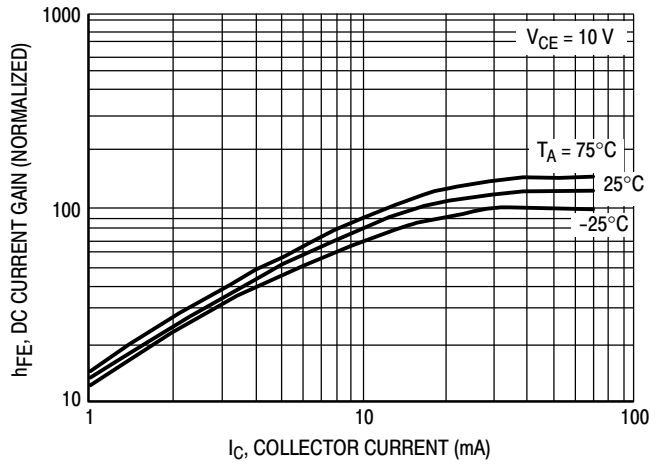

Figure 3. DC Current Gain

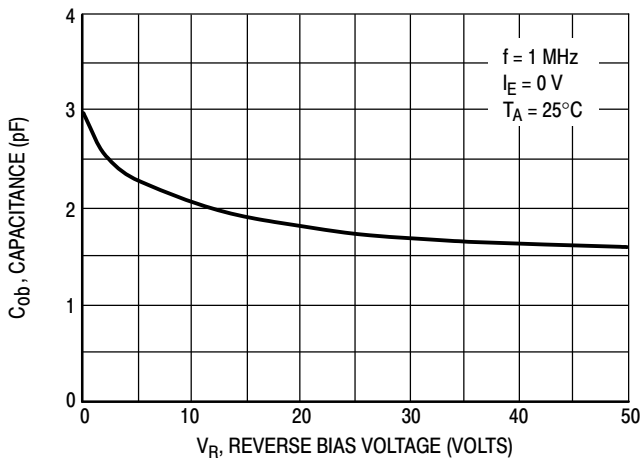

Figure 4. Output Capacitance

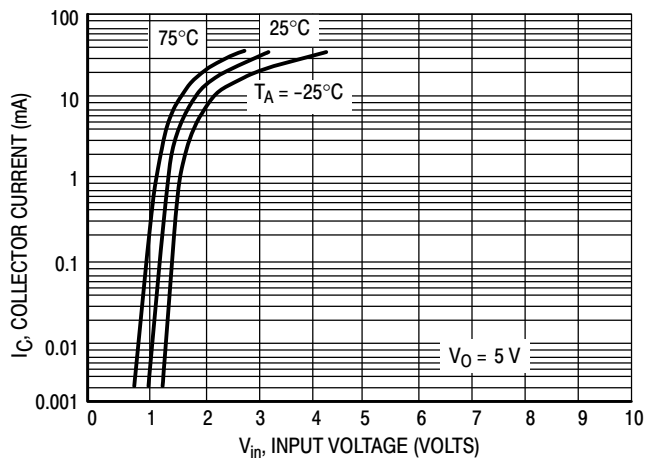

Figure 5. Output Current versus Input Voltage

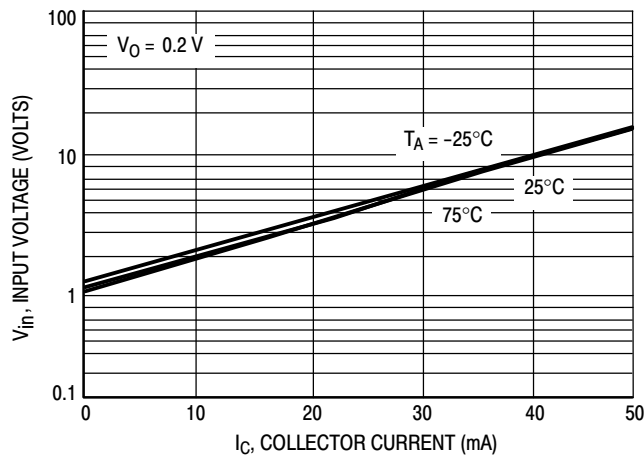

Figure 6. Input Voltage versus Output Current

MUN511T1 Series

TYPICAL ELECTRICAL CHARACTERISTICS – MUN5112T1

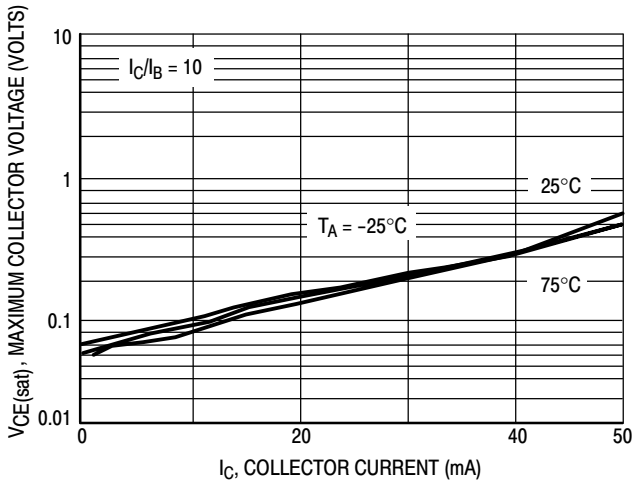

Figure 7. $V_{CE(sat)}$ versus I_C

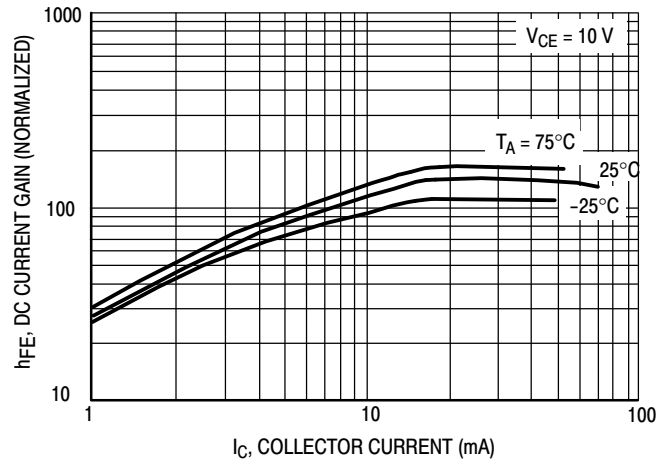

Figure 8. DC Current Gain

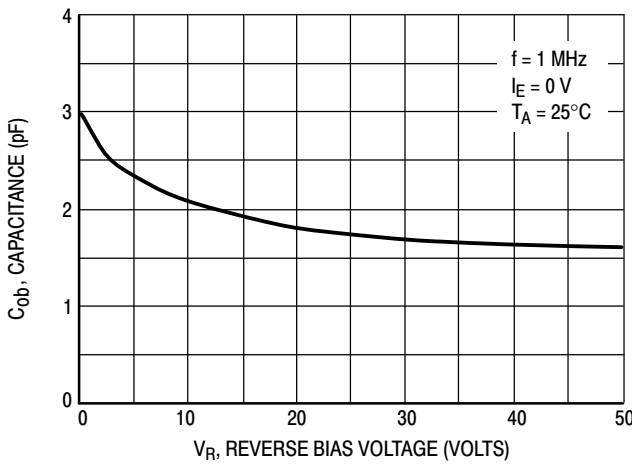

Figure 9. Output Capacitance

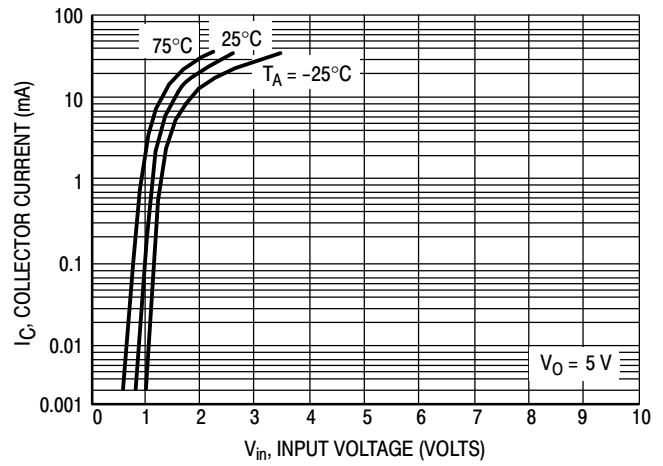

Figure 10. Output Current versus Input Voltage

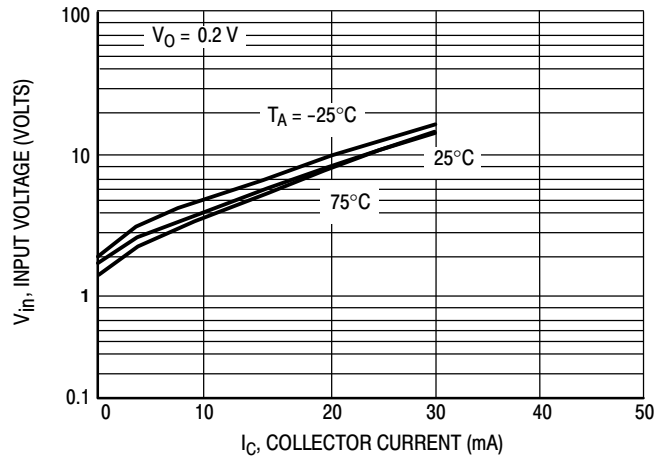

Figure 11. Input Voltage versus Output Current

MUN511T1 Series

TYPICAL ELECTRICAL CHARACTERISTICS – MUN5113T1

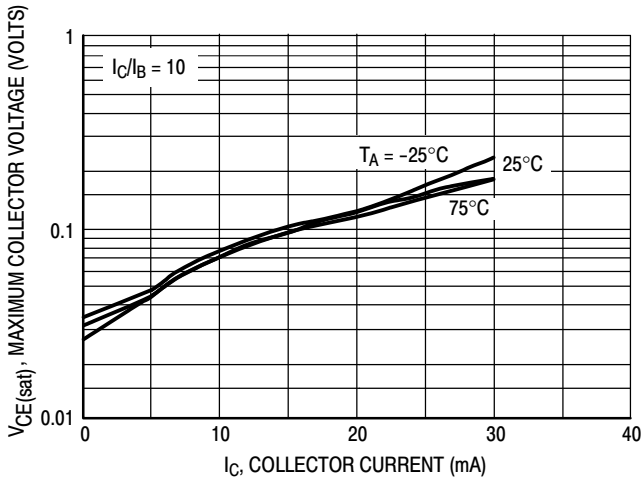

Figure 12. $V_{CE(sat)}$ versus I_C

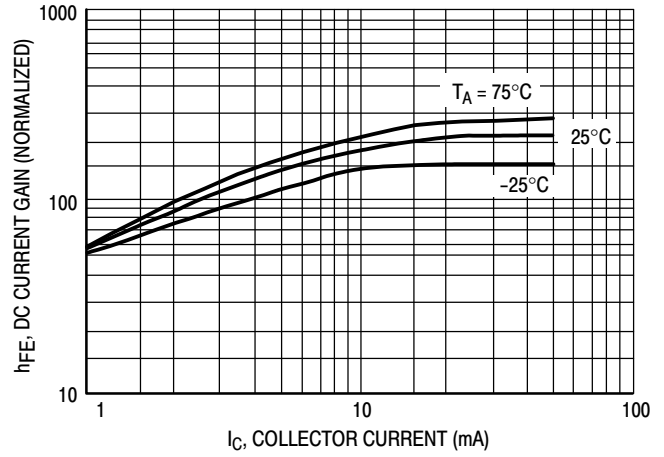

Figure 13. DC Current Gain

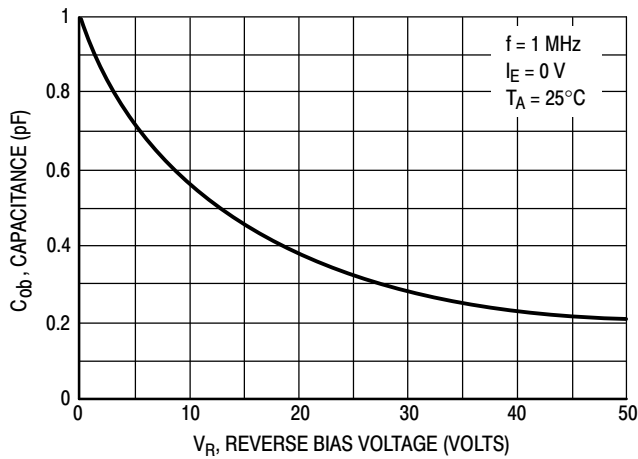

Figure 14. Output Capacitance

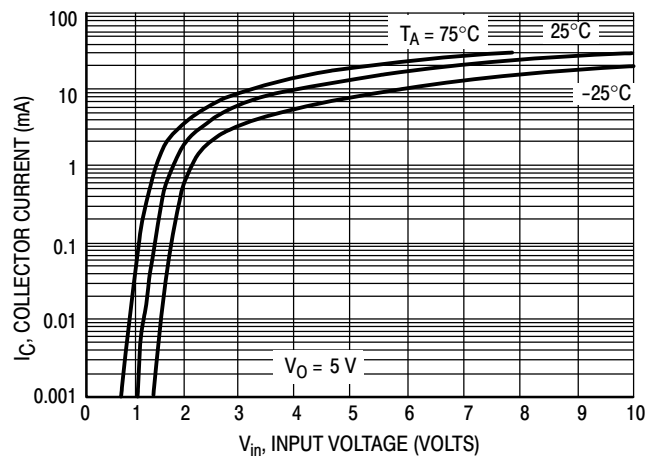

Figure 15. Output Current versus Input Voltage

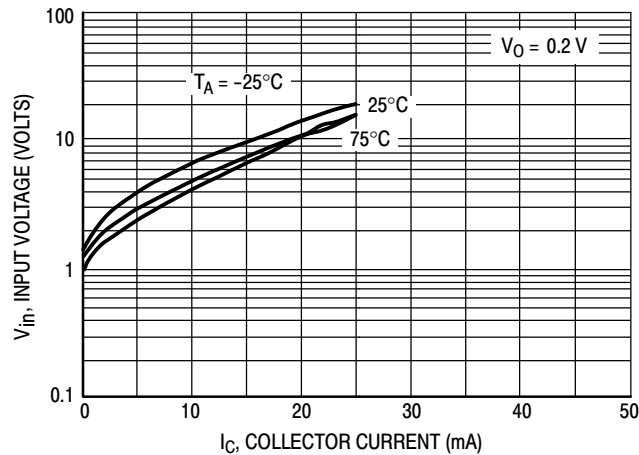

Figure 16. Input Voltage versus Output Current

MUN511T1 Series

TYPICAL ELECTRICAL CHARACTERISTICS – MUN5114T1

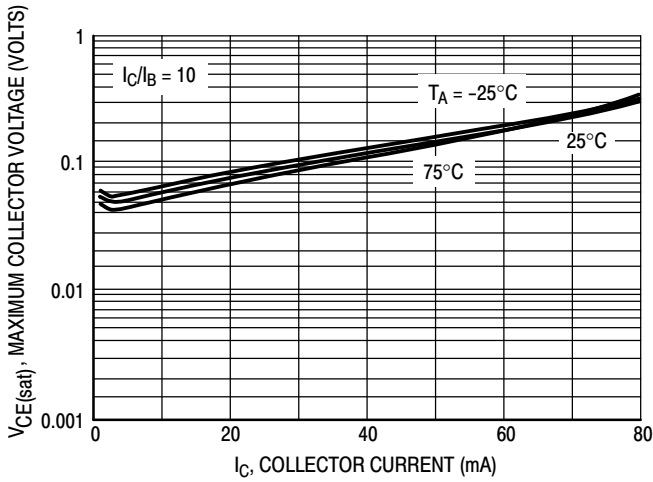

Figure 17. $V_{CE(sat)}$ versus I_C

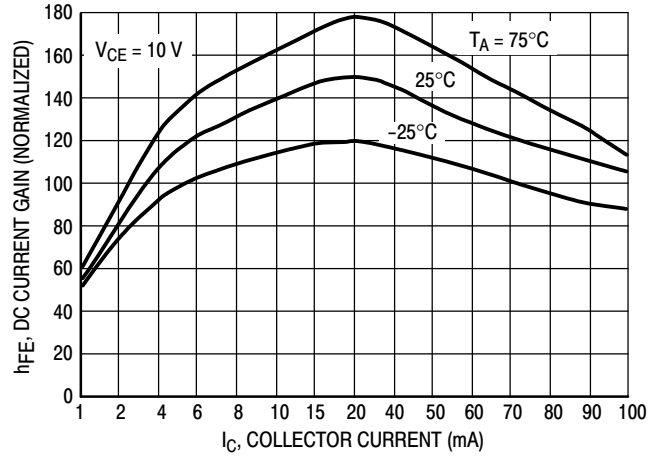

Figure 18. DC Current Gain

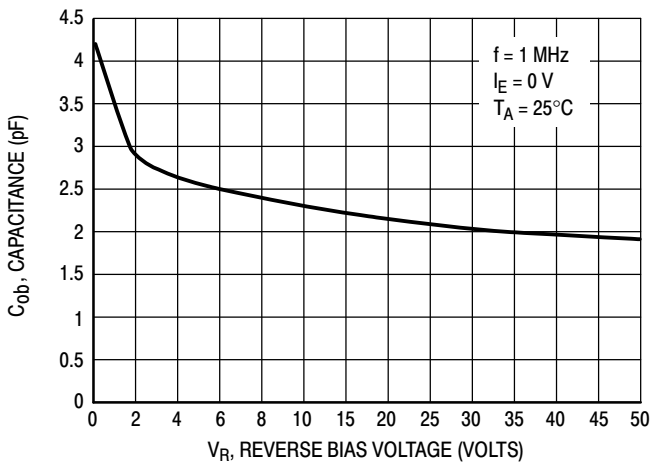

Figure 19. Output Capacitance

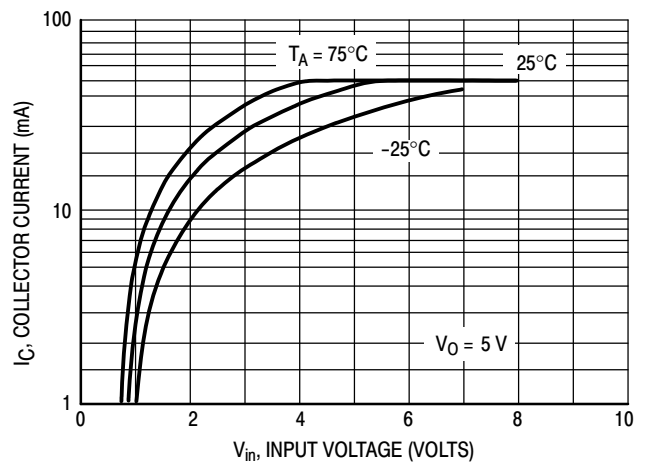

Figure 20. Output Current versus Input Voltage

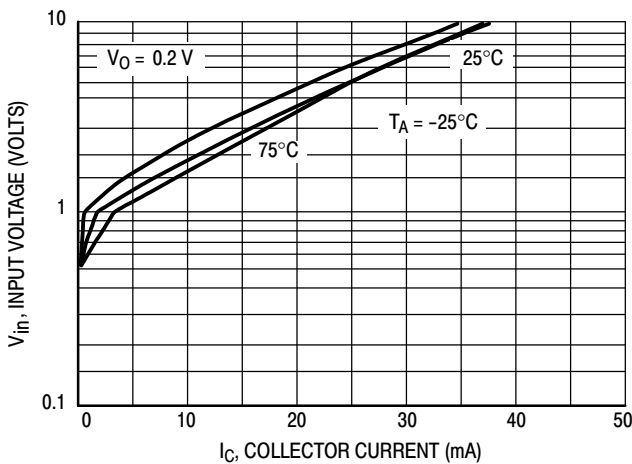

Figure 21. Input Voltage versus Output Current

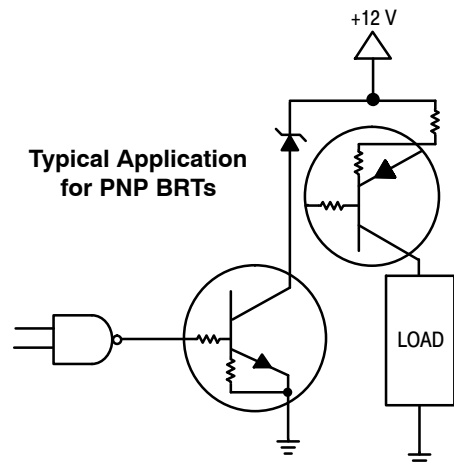

Figure 22. Inexpensive, Unregulated Current Source

MUN5111T1 Series

TYPICAL ELECTRICAL CHARACTERISTICS — MUN5132T1

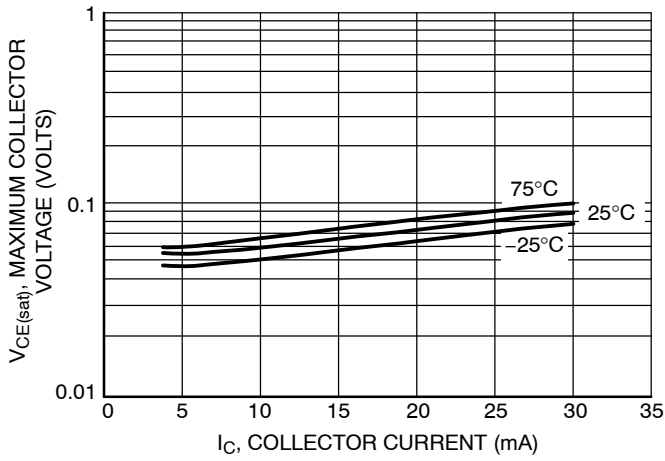

Figure 23. Maximum Collector Voltage versus Collector Current

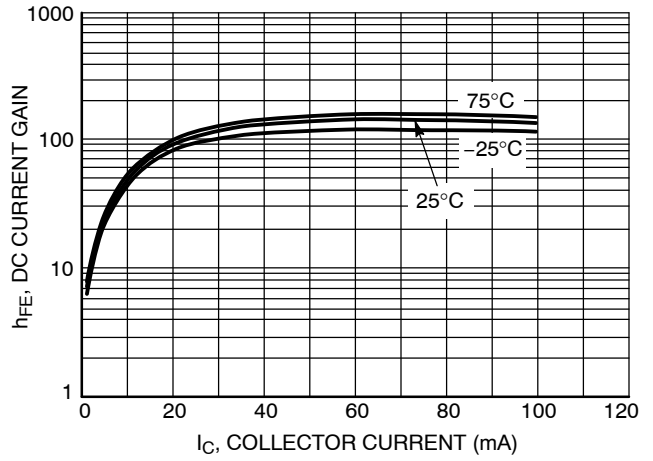

Figure 24. DC Current Gain

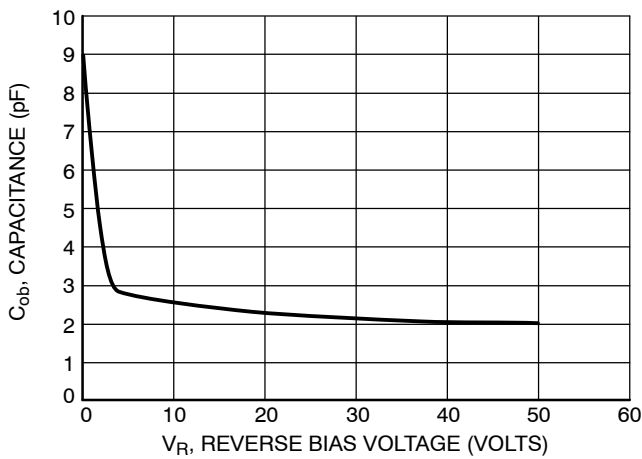

Figure 25. Output Capacitance

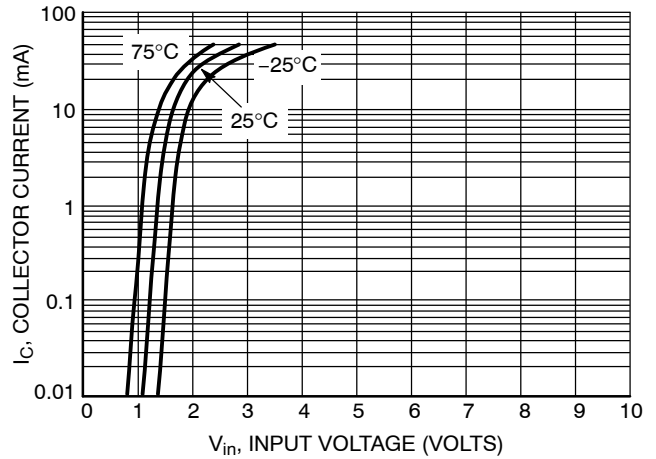

Figure 26. Output Current versus Input Voltage

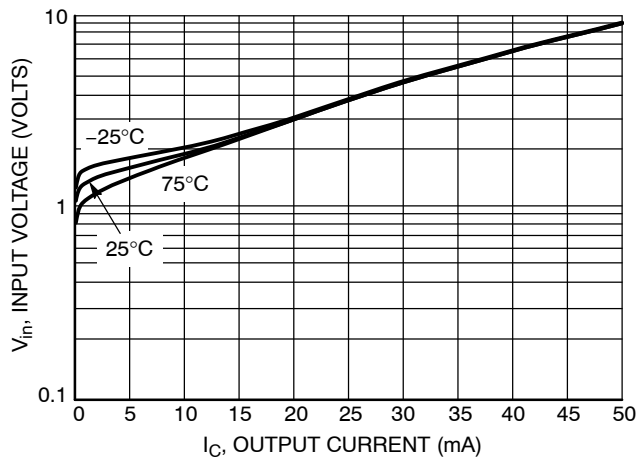

Figure 27. Input Voltage versus Output Current

MUN5111T1 Series

TYPICAL ELECTRICAL CHARACTERISTICS — MUN5133T1

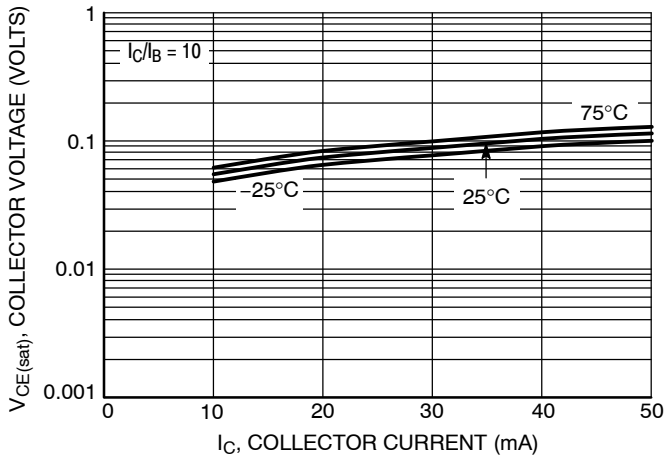

Figure 28. $V_{CE(sat)}$ versus I_C

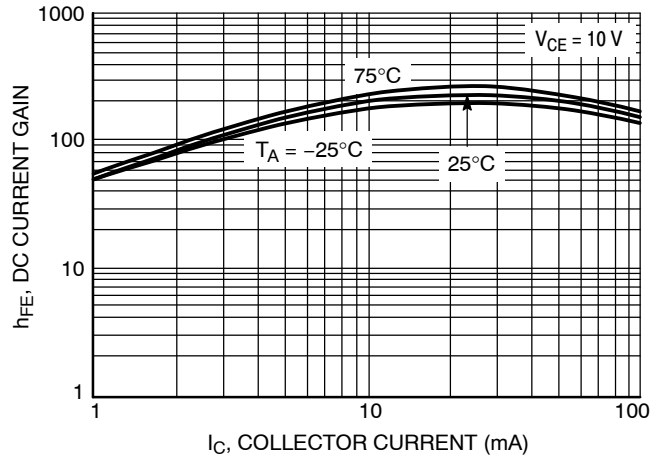

Figure 29. DC Current Gain

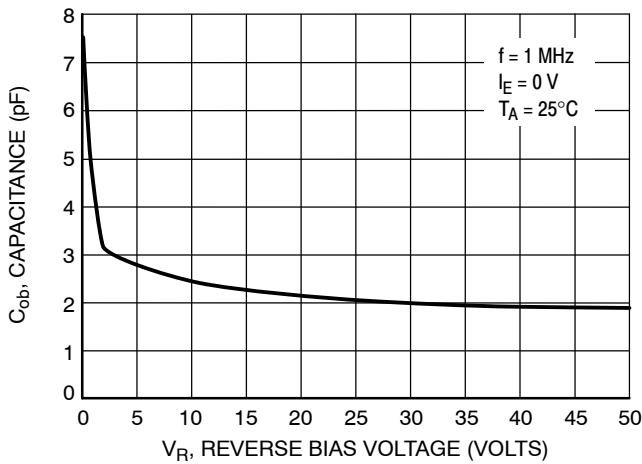

Figure 30. Output Capacitance

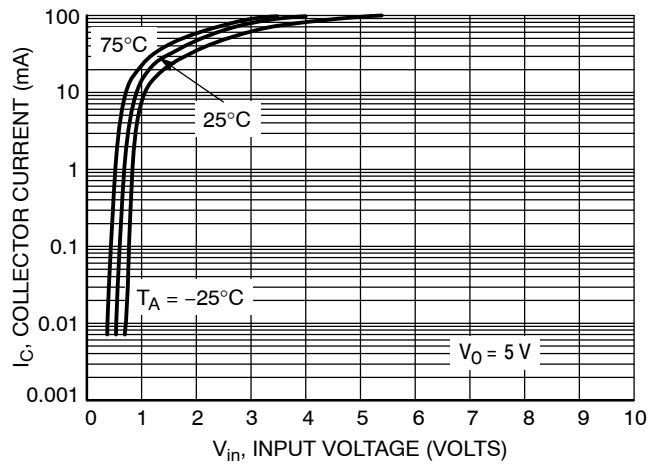

Figure 31. Output Current versus Input Voltage

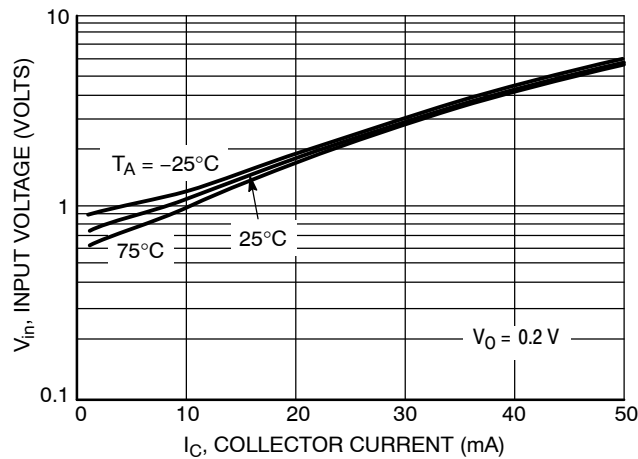

Figure 32. Input Voltage versus Output Current

MUN511T1 Series

TYPICAL ELECTRICAL CHARACTERISTICS — MUN5136T1

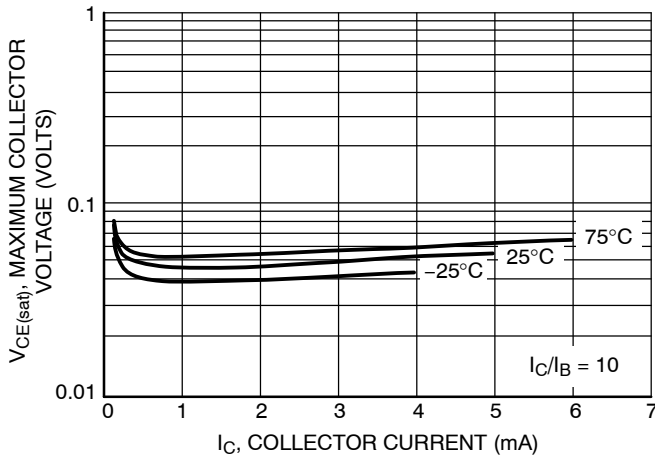

Figure 33. Maximum Collector Voltage versus Collector Current

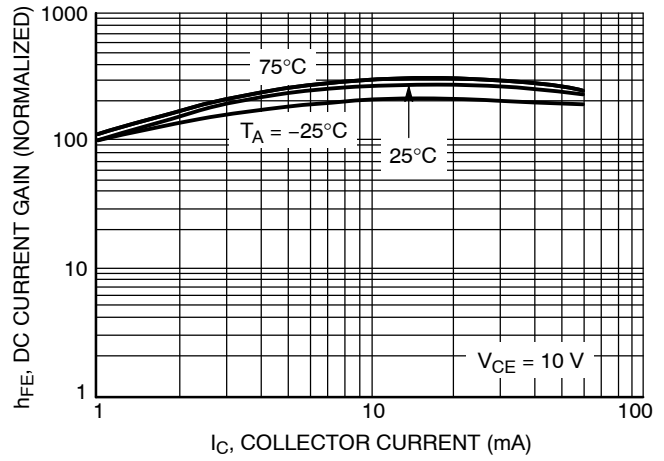

Figure 34. DC Current Gain

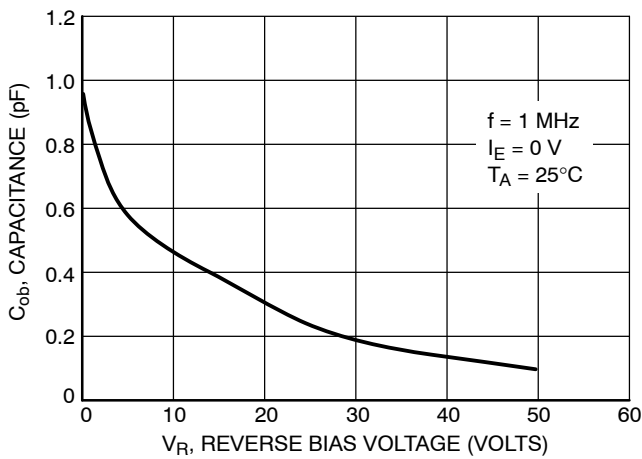

Figure 35. Output Capacitance

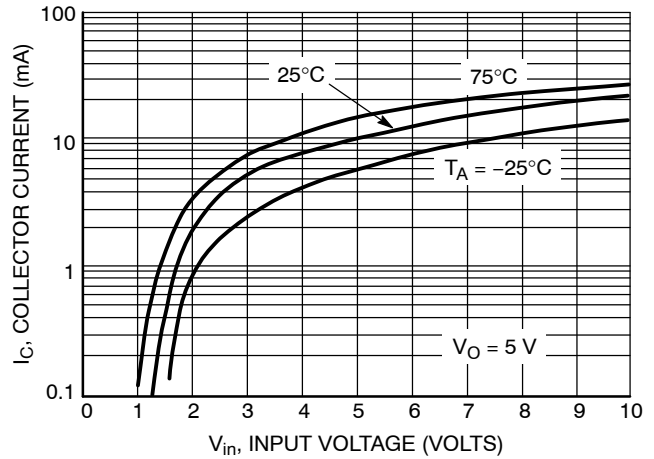

Figure 36. Output Current versus Input Voltage

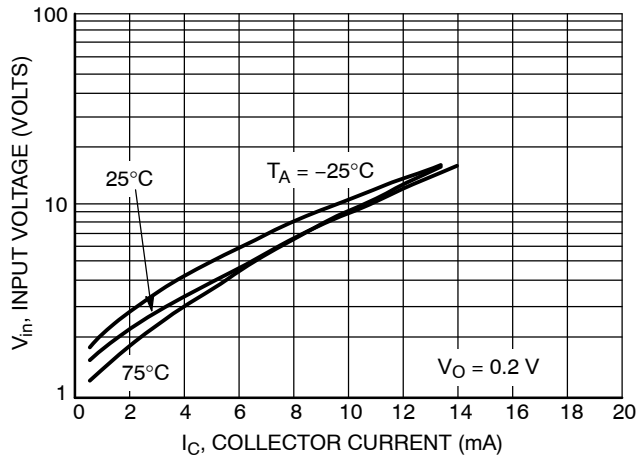

Figure 37. Input Voltage versus Output Current

MUN511T1 Series

TYPICAL ELECTRICAL CHARACTERISTICS — MUN5137T1

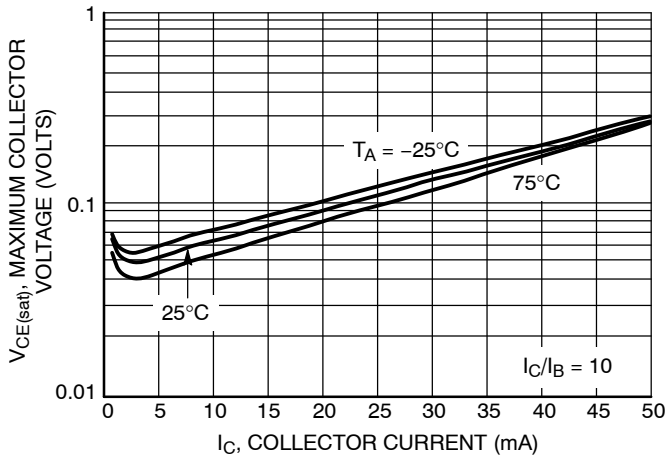

Figure 38. Maximum Collector Voltage versus Collector Current

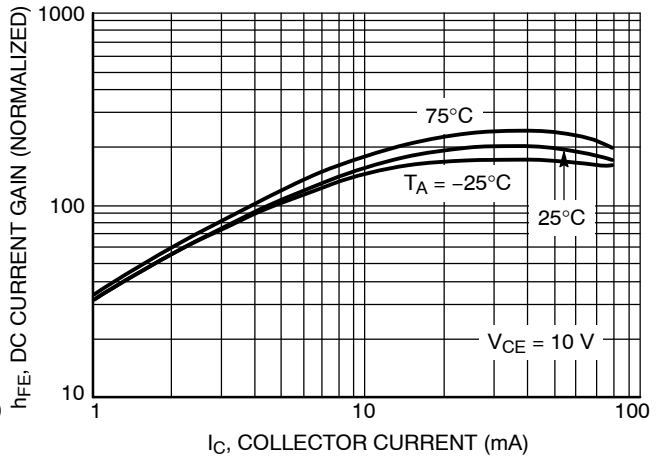

Figure 39. DC Current Gain

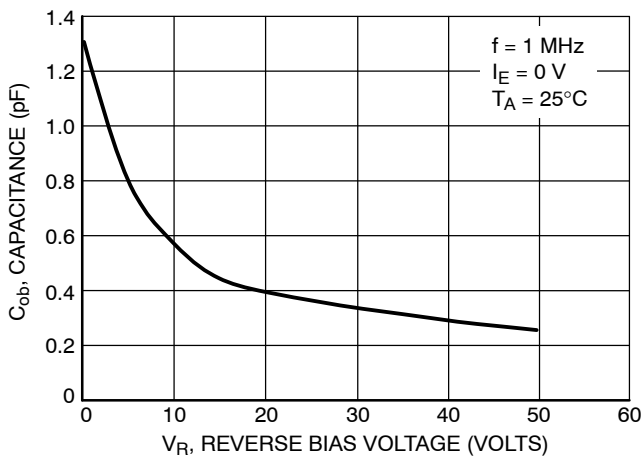

Figure 40. Output Capacitance

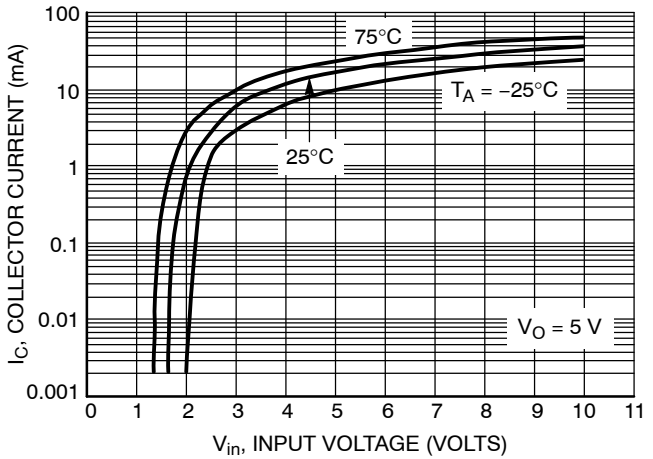

Figure 41. Output Current versus Input Voltage

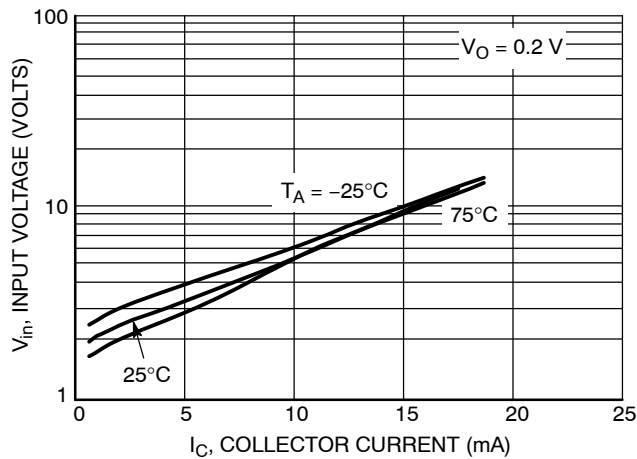
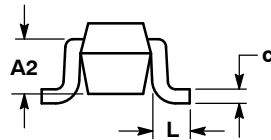
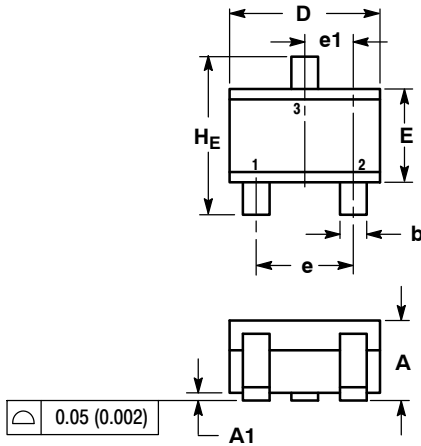

Figure 42. Input Voltage versus Output Current

MUN511T1 Series

PACKAGE DIMENSIONS

SC-70/SOT-323
CASE 419-04
ISSUE N



- NOTES:
1. DIMENSIONING AND TOLERANCING PER ANSI Y14.5M, 1982.
2. CONTROLLING DIMENSION: INCH.

DIM	MILLIMETERS			INCHES		
	MIN	NOM	MAX	MIN	NOM	MAX
A	0.80	0.90	1.00	0.032	0.035	0.040
A1	0.00	0.05	0.10	0.000	0.002	0.004
A2	0.70 REF			0.028 REF		
b	0.30	0.35	0.40	0.012	0.014	0.016
c	0.10	0.18	0.25	0.004	0.007	0.010
D	1.80	2.10	2.20	0.071	0.083	0.087
E	1.15	1.24	1.35	0.045	0.049	0.053
e	1.20	1.30	1.40	0.047	0.051	0.055
e1	0.65 BSC			0.026 BSC		
L	0.20	0.38	0.56	0.008	0.015	0.022
HE	2.00	2.10	2.40	0.079	0.083	0.095

STYLE 3:
PIN 1. BASE
2. EMITTER
3. COLLECTOR

SOLDERING FOOTPRINT*

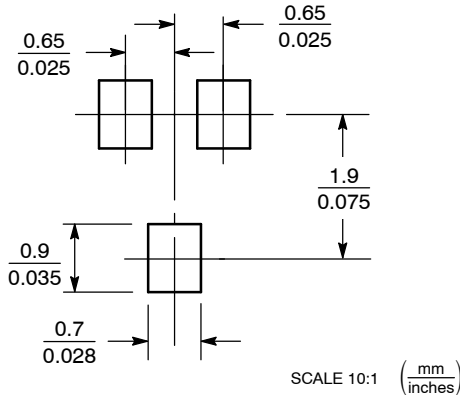

*For additional information on our Pb-Free strategy and soldering details, please download the ON Semiconductor Soldering and Mounting Techniques Reference Manual, SOLDERRM/D.

ON Semiconductor and are registered trademarks of Semiconductor Components Industries, LLC (SCILLC). SCILLC reserves the right to make changes without further notice to any products herein. SCILLC makes no warranty, representation or guarantee regarding the suitability of its products for any particular purpose, nor does SCILLC assume any liability arising out of the application or use of any product or circuit, and specifically disclaims any and all liability, including without limitation special, consequential or incidental damages. "Typical" parameters which may be provided in SCILLC data sheets and/or specifications can and do vary in different applications and actual performance may vary over time. All operating parameters, including "Typicals" must be validated for each customer application by customer's technical experts. SCILLC does not convey any license under its patent rights nor the rights of others. SCILLC products are not designed, intended, or authorized for use as components in systems intended for surgical implant into the body, or other applications intended to support or sustain life, or for any other application in which the failure of the SCILLC product could create a situation where personal injury or death may occur. Should Buyer purchase or use SCILLC products for any such unintended or unauthorized application, Buyer shall indemnify and hold SCILLC and its officers, employees, subsidiaries, affiliates, and distributors harmless against all claims, costs, damages, and expenses, and reasonable attorney fees arising out of, directly or indirectly, any claim of personal injury or death associated with such unintended or unauthorized use, even if such claim alleges that SCILLC was negligent regarding the design or manufacture of the part. SCILLC is an Equal Opportunity/Affirmative Action Employer. This literature is subject to all applicable copyright laws and is not for resale in any manner.

PUBLICATION ORDERING INFORMATION

LITERATURE FULFILLMENT:
Literature Distribution Center for ON Semiconductor
P.O. Box 5163, Denver, Colorado 80217 USA
Phone: 303-675-2175 or 800-344-3860 Toll Free USA/Canada
Fax: 303-675-2176 or 800-344-3867 Toll Free USA/Canada
Email: orderlit@onsemi.com

N. American Technical Support: 800-282-9855 Toll Free USA/Canada
Europe, Middle East and Africa Technical Support:
Phone: 421 33 790 2910
Japan Customer Focus Center
Phone: 81-3-5773-3850

ON Semiconductor Website: www.onsemi.com

Order Literature: <http://www.onsemi.com/orderlit>

For additional information, please contact your local Sales Representative

