

NTD4302

Power MOSFET 68 Amps, 30 Volts

N-Channel DPAK

Features

- Ultra Low $R_{DS(on)}$
- Higher Efficiency Extending Battery Life
- Logic Level Gate Drive
- Diode Exhibits High Speed, Soft Recovery
- Avalanche Energy Specified
- I_{DSS} Specified at Elevated Temperature
- DPAK Mounting Information Provided

Applications

- DC-DC Converters
- Low Voltage Motor Control
- Power Management in Portable and Battery Powered Products:
i.e., Computers, Printers, Cellular and Cordless Telephones, and PCMCIA Cards



ON Semiconductor™

<http://onsemi.com>

**68 AMPERES
30 VOLTS**

10 mΩ @ $V_{GS} = 10 V$

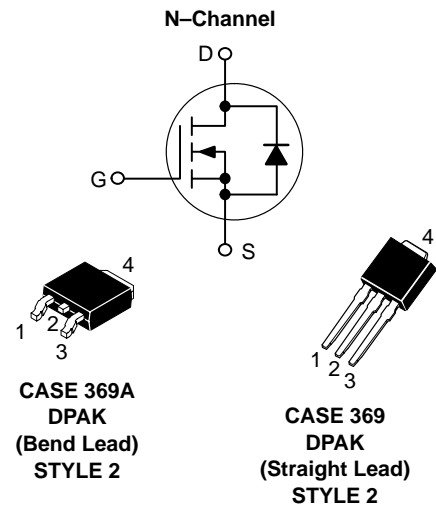

MARKING DIAGRAMS & PIN ASSIGNMENTS

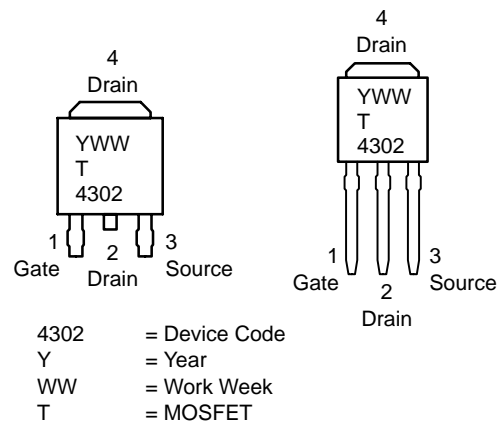

ORDERING INFORMATION

Device	Package	Shipping
NTD4302	DPAK	75 Units/Rail
NTD4302-1	DPAK Straight Lead	75 Units/Rail
NTD4302T4	DPAK	2500/Tape & Reel

NTD4302

MAXIMUM RATINGS ($T_C = 25^\circ\text{C}$ unless otherwise noted)

Rating	Symbol	Value	Unit
Drain-to-Source Voltage	V_{DSS}	30	Vdc
Gate-to-Source Voltage – Continuous	V_{GS}	± 20	Vdc
Thermal Resistance – Junction-to-Ambient (Note 1) Total Power Dissipation @ $T_A = 25^\circ\text{C}$ Continuous Drain Current @ $T_A = 25^\circ\text{C}$ (Note 6) Continuous Drain Current @ $T_A = 100^\circ\text{C}$	$R_{\theta JC}$ P_D I_D I_D	1.65 75 68 43	$^\circ\text{C/W}$ Watts Amps Amps
Thermal Resistance – Junction-to-Ambient (Note 2) Total Power Dissipation @ $T_A = 25^\circ\text{C}$ Continuous Drain Current @ $T_A = 25^\circ\text{C}$ Continuous Drain Current @ $T_A = 100^\circ\text{C}$ Pulsed Drain Current (Note 5)	$R_{\theta JA}$ P_D I_D I_D I_{DM}	25 5.0 18.5 11.5 60	$^\circ\text{C/W}$ Watts Amps Amps Amps
Thermal Resistance – Junction-to-Ambient (Note 3) Total Power Dissipation @ $T_A = 25^\circ\text{C}$ Continuous Drain Current @ $T_A = 25^\circ\text{C}$ Continuous Drain Current @ $T_A = 100^\circ\text{C}$ Pulsed Drain Current (Note 5)	$R_{\theta JA}$ P_D I_D I_D I_{DM}	67 1.87 11.3 7.1 36	$^\circ\text{C/W}$ Watts Amps Amps Amps
Thermal Resistance – Junction-to-Ambient (Note 4) Total Power Dissipation @ $T_A = 25^\circ\text{C}$ Continuous Drain Current @ $T_A = 25^\circ\text{C}$ Continuous Drain Current @ $T_A = 100^\circ\text{C}$ Pulsed Drain Current (Note 5)	$R_{\theta JA}$ P_D I_D I_D I_{DM}	120 1.04 8.4 5.3 28	$^\circ\text{C/W}$ Watts Amps Amps Amps
Operating and Storage Temperature Range	T_J, T_{stg}	-55 to 150	$^\circ\text{C}$
Single Pulse Drain-to-Source Avalanche Energy – Starting $T_J = 25^\circ\text{C}$ ($V_{DD} = 30$ Vdc, $V_{GS} = 10$ Vdc, Peak $I_L = 17$ Apk, $L = 5.0$ mH, $R_G = 25$ Ω)	E_{AS}	722	mJ
Maximum Lead Temperature for Soldering Purposes, 1/8" from case for 10 seconds	T_L	260	$^\circ\text{C}$

1. Mounted on Heat Sink, Steady State.
2. Mounted on 2" square FR-4 Board (1" sq. 2 oz. Cu 0.06" thick single sided), Time ≤ 10 seconds.
3. Mounted on 2" square FR-4 Board (1" sq. 2 oz. Cu 0.06" thick single sided), Steady State.
4. Minimum FR-4 or G-10 PCB, Steady State.
5. Pulse Test: Pulse Width = 300 μs , Duty Cycle = 2%.
6. Current Limited by Internal Lead Wires.

NTD4302

ELECTRICAL CHARACTERISTICS (T_J = 25°C unless otherwise noted)

Characteristic	Symbol	Min	Typ	Max	Unit
----------------	--------	-----	-----	-----	------

OFF CHARACTERISTICS

Drain-Source Breakdown Voltage (V _{GS} = 0 Vdc, I _D = 250 μA) Positive Temperature Coefficient	V _{(BR)DSS}	30 -	- 25	- -	Vdc mV/°C
Zero Gate Voltage Drain Current (V _{GS} = 0 Vdc, V _{DS} = 30 Vdc, T _J = 25°C) (V _{GS} = 0 Vdc, V _{DS} = 30 Vdc, T _J = 125°C)	I _{DSS}	- -	- -	1.0 10	μAdc
Gate-Body Leakage Current (V _{GS} = ±20 Vdc, V _{DS} = 0 Vdc)	I _{GSS}	-	-	±100	nAdc

ON CHARACTERISTICS

Gate Threshold Voltage (V _{DS} = V _{GS} , I _D = 250 μAdc) Negative Temperature Coefficient	V _{GS(th)}	1.0 -	1.9 -3.8	3.0 -	Vdc
Static Drain-Source On-State Resistance (V _{GS} = 10 Vdc, I _D = 20 Adc) (V _{GS} = 10 Vdc, I _D = 10 Adc) (V _{GS} = 4.5 Vdc, I _D = 5.0 Adc)	R _{DS(on)}	- - -	0.0078 0.0078 0.010	0.010 0.010 0.013	Ω
Forward Transconductance (V _{DS} = 15 Vdc, I _D = 10 Adc)	g _{FS}	-	20	-	Mhos

DYNAMIC CHARACTERISTICS

Input Capacitance	(V _{DS} = 24 Vdc, V _{GS} = 0 Vdc, f = 1.0 MHz)	C _{iss}	-	2050	2400	pF
Output Capacitance		C _{oss}	-	640	800	
Reverse Transfer Capacitance		C _{rss}	-	225	310	

SWITCHING CHARACTERISTICS (Note 8)

Turn-On Delay Time	(V _{DD} = 25 Vdc, I _D = 1.0 Adc, V _{GS} = 10 Vdc, R _G = 6.0 Ω)	t _{d(on)}	-	11	20	ns
Rise Time		t _r	-	15	25	
Turn-Off Delay Time		t _{d(off)}	-	85	130	
Fall Time		t _f	-	55	90	
Turn-On Delay Time	(V _{DD} = 25 Vdc, I _D = 1.0 Adc, V _{GS} = 10 Vdc, R _G = 2.5 Ω)	t _{d(on)}	-	11	20	ns
Rise Time		t _r	-	13	20	
Turn-Off Delay Time		t _{d(off)}	-	55	90	
Fall Time		t _f	-	40	75	
Turn-On Delay Time	(V _{DD} = 24 Vdc, I _D = 20 Adc, V _{GS} = 10 Vdc, R _G = 2.5 Ω)	t _{d(on)}	-	15	-	ns
Rise Time		t _r	-	25	-	
Turn-Off Delay Time		t _{d(off)}	-	40	-	
Fall Time		t _f	-	58	-	
Gate Charge	(V _{DS} = 24 Vdc, I _D = 2.0 Adc, V _{GS} = 10 Vdc)	Q _T	-	55	80	nC
		Q _{GS} (Q1)	-	5.5	-	
		Q _{gd} (Q2)	-	15	-	

BODY-DRAIN DIODE RATINGS (Note 7)

Diode Forward On-Voltage (I _S = 2.3 Adc, V _{GS} = 0 Vdc) (I _S = 20 Adc, V _{GS} = 0 Vdc) (I _S = 2.3 Adc, V _{GS} = 0 Vdc, T _J = 125°C)	V _{SD}	- - -	0.75 0.90 0.65	1.0 - -	Vdc	
Reverse Recovery Time	(I _S = 2.3 Adc, V _{GS} = 0 Vdc, dI _S /dt = 100 A/μs)	t _{rr}	-	39	65	ns
		t _a	-	20	-	
		t _b	-	19	-	
Reverse Recovery Stored Charge	Q _{rr}	-	0.043	-	μC	

7. Indicates Pulse Test: Pulse Width = 300 μsec max, Duty Cycle ≤ 2%.

8. Switching characteristics are independent of operating junction temperature.

NTD4302

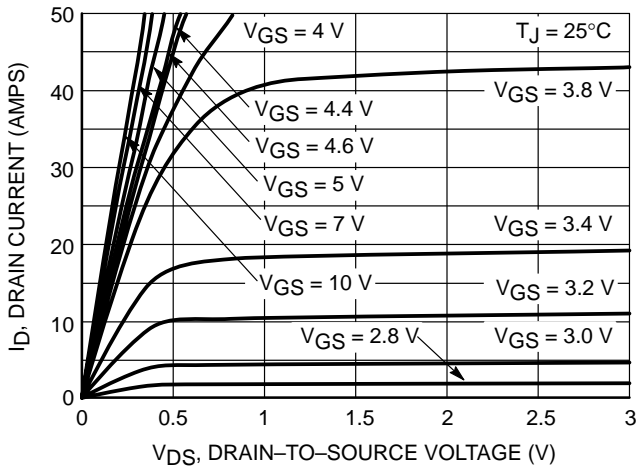

Figure 1. On-Region Characteristics

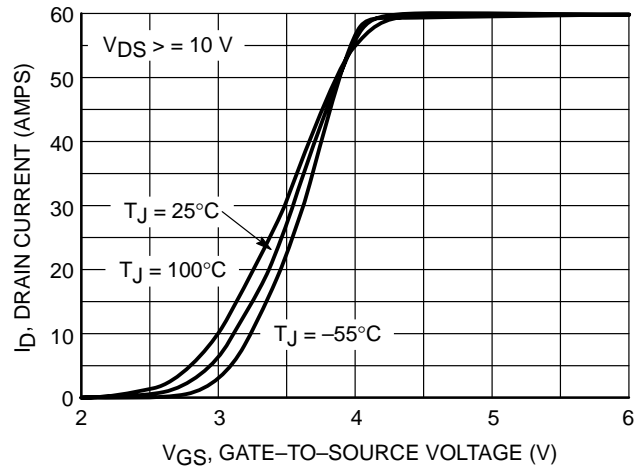

Figure 2. Transfer Characteristics

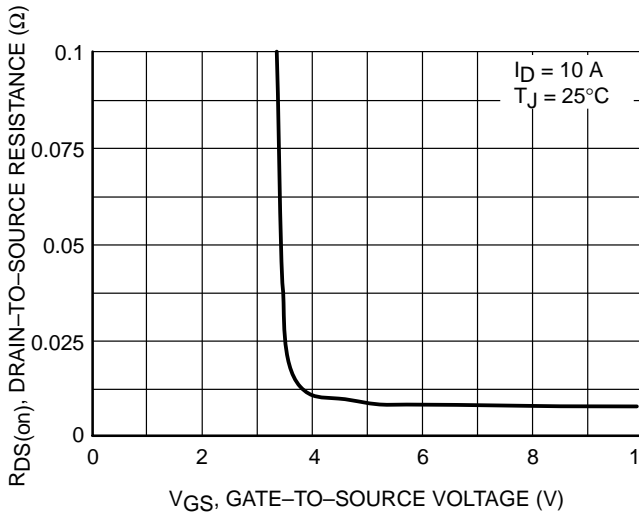

Figure 3. On-Resistance vs. Gate-to-Source Voltage

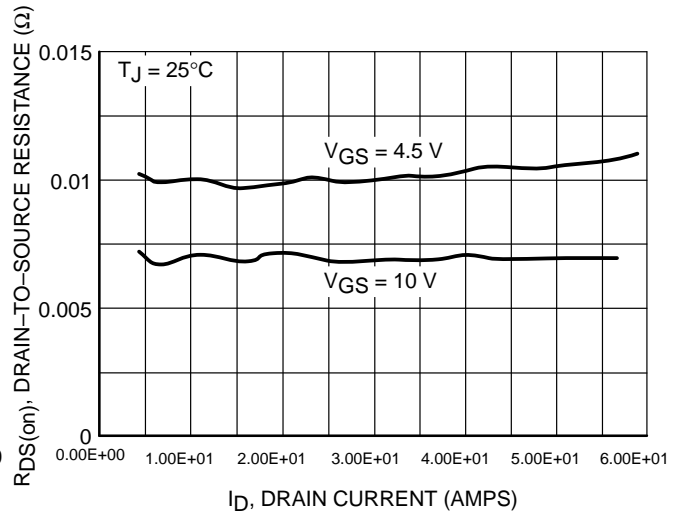

Figure 4. On-Resistance vs. Drain Current and Gate Voltage

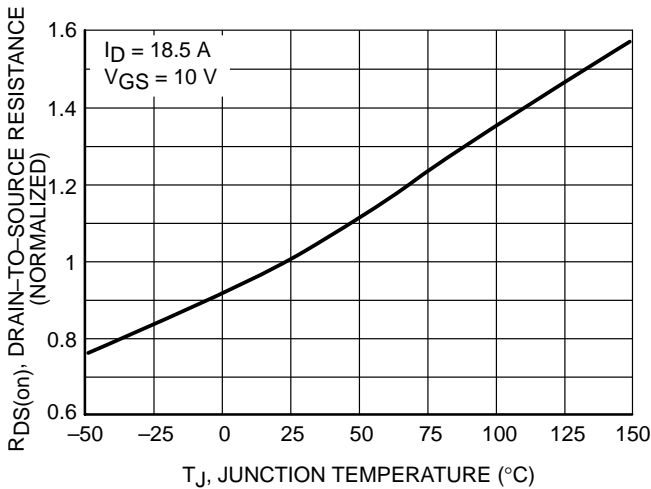

Figure 5. On-Resistance Variation with Temperature

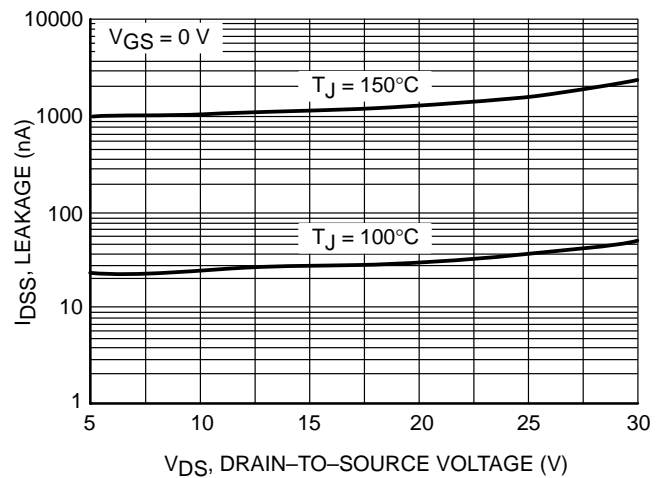

Figure 6. Drain-to-Source Leakage Current vs. Voltage

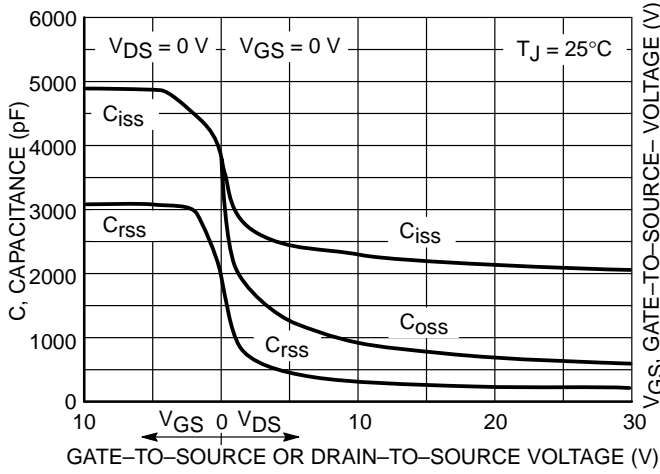

Figure 7. Capacitance Variation

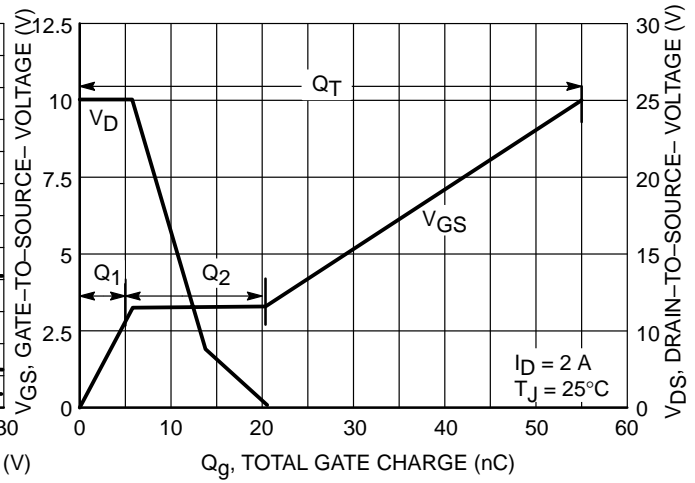

Figure 8. Gate-to-Source and Drain-to-Source Voltage vs. Total Charge

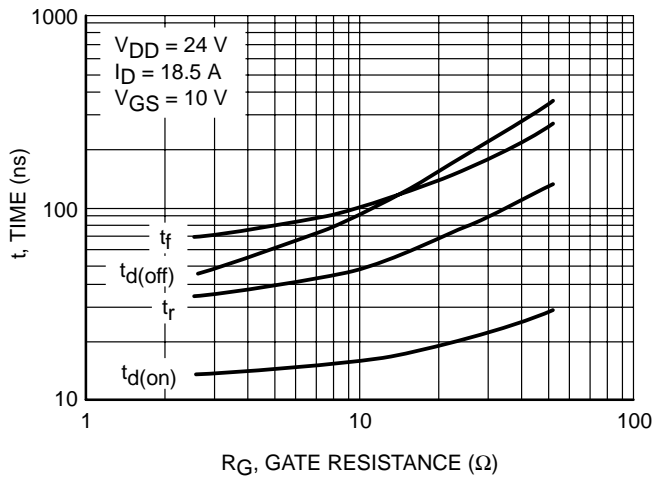

Figure 9. Resistive Switching Time Variation vs. Gate Resistance

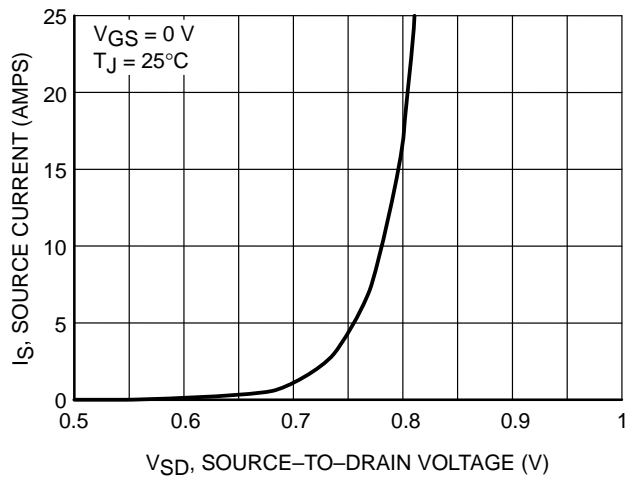

Figure 10. Diode Forward Voltage vs. Current

NTD4302

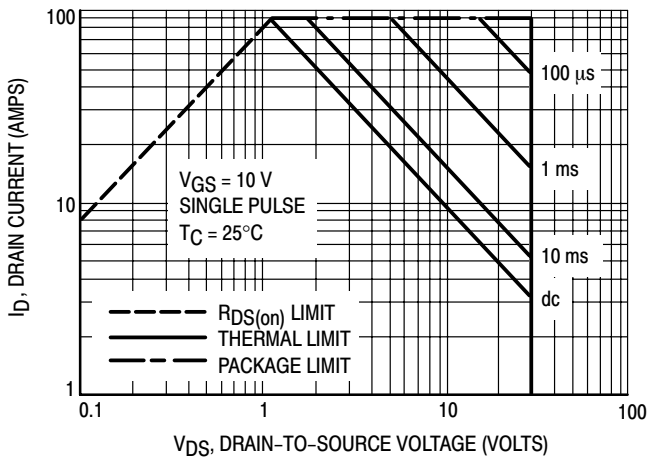

Figure 11. Maximum Rated Forward Biased Safe Operating Area

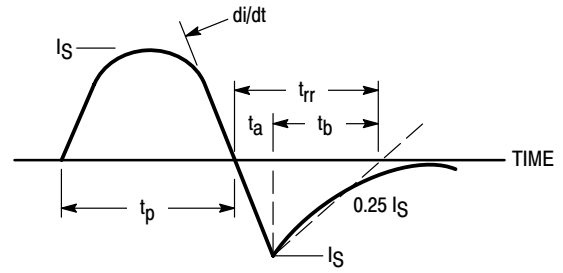

Figure 12. Diode Reverse Recovery Waveform

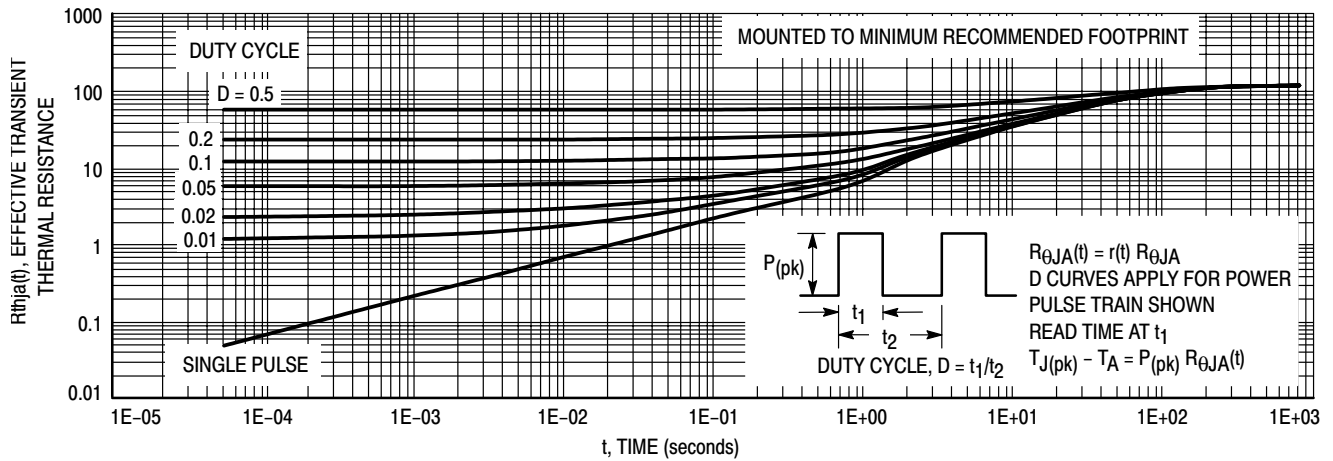

Figure 13. Thermal Response – Various Duty Cycles

INFORMATION FOR USING THE DPAK SURFACE MOUNT PACKAGE

RECOMMENDED FOOTPRINT FOR SURFACE MOUNTED APPLICATIONS

Surface mount board layout is a critical portion of the total design. The footprint for the semiconductor packages must be the correct size to ensure proper solder connection

interface between the board and the package. With the correct pad geometry, the packages will self align when subjected to a solder reflow process.

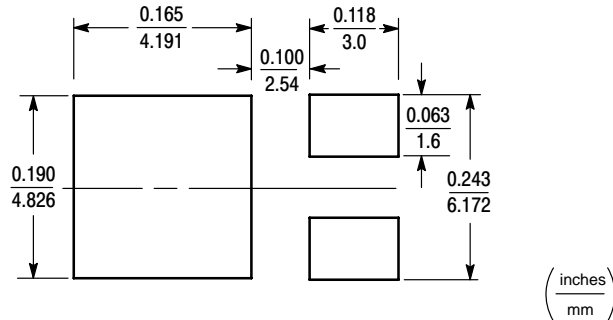

SOLDER STENCIL GUIDELINES

Prior to placing surface mount components onto a printed circuit board, solder paste must be applied to the pads. Solder stencils are used to screen the optimum amount. These stencils are typically 0.008 inches thick and may be made of brass or stainless steel. For packages such as the SC-59, SC-70/SOT-323, SOD-123, SOT-23, SOT-143, SOT-223, SO-8, SO-14, SO-16, and SMB/SMC diode packages, the stencil opening should be the same as the pad size or a 1:1 registration. This is not the case with the DPAK and D²PAK packages. If one uses a 1:1 opening to screen solder onto the drain pad, misalignment and/or “tombstoning” may occur due to an excess of solder. For these two packages, the opening in the stencil for the paste should be approximately 50% of the tab area. The opening for the leads is still a 1:1 registration. Figure 14 shows a typical stencil for the DPAK and D²PAK packages. The

pattern of the opening in the stencil for the drain pad is not critical as long as it allows approximately 50% of the pad to be covered with paste.

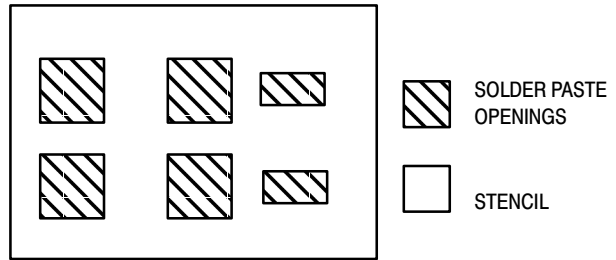

Figure 14. Typical Stencil for DPAK and D²PAK Packages

SOLDERING PRECAUTIONS

The melting temperature of solder is higher than the rated temperature of the device. When the entire device is heated to a high temperature, failure to complete soldering within a short time could result in device failure. Therefore, the following items should always be observed in order to minimize the thermal stress to which the devices are subjected.

- Always preheat the device.
- The delta temperature between the preheat and soldering should be 100°C or less.*
- When preheating and soldering, the temperature of the leads and the case must not exceed the maximum temperature ratings as shown on the data sheet. When using infrared heating with the reflow soldering method, the difference shall be a maximum of 10°C.
- The soldering temperature and time shall not exceed 260°C for more than 10 seconds.

- When shifting from preheating to soldering, the maximum temperature gradient shall be 5°C or less.
- After soldering has been completed, the device should be allowed to cool naturally for at least three minutes. Gradual cooling should be used as the use of forced cooling will increase the temperature gradient and result in latent failure due to mechanical stress.
- Mechanical stress or shock should not be applied during cooling.

* * Soldering a device without preheating can cause excessive thermal shock and stress which can result in damage to the device.

* * Due to shadowing and the inability to set the wave height to incorporate other surface mount components, the D²PAK is not recommended for wave soldering.

TYPICAL SOLDER HEATING PROFILE

For any given circuit board, there will be a group of control settings that will give the desired heat pattern. The operator must set temperatures for several heating zones and a figure for belt speed. Taken together, these control settings make up a heating “profile” for that particular circuit board. On machines controlled by a computer, the computer remembers these profiles from one operating session to the next. Figure 15 shows a typical heating profile for use when soldering a surface mount device to a printed circuit board. This profile will vary among soldering systems, but it is a good starting point. Factors that can affect the profile include the type of soldering system in use, density and types of components on the board, type of solder used, and the type of board or substrate material being used. This profile shows

temperature versus time. The line on the graph shows the actual temperature that might be experienced on the surface of a test board at or near a central solder joint. The two profiles are based on a high density and a low density board. The Vitronics SMD310 convection/infrared reflow soldering system was used to generate this profile. The type of solder used was 62/36/2 Tin Lead Silver with a melting point between 177–189°C. When this type of furnace is used for solder reflow work, the circuit boards and solder joints tend to heat first. The components on the board are then heated by conduction. The circuit board, because it has a large surface area, absorbs the thermal energy more efficiently, then distributes this energy to the components. Because of this effect, the main body of a component may be up to 30 degrees cooler than the adjacent solder joints.

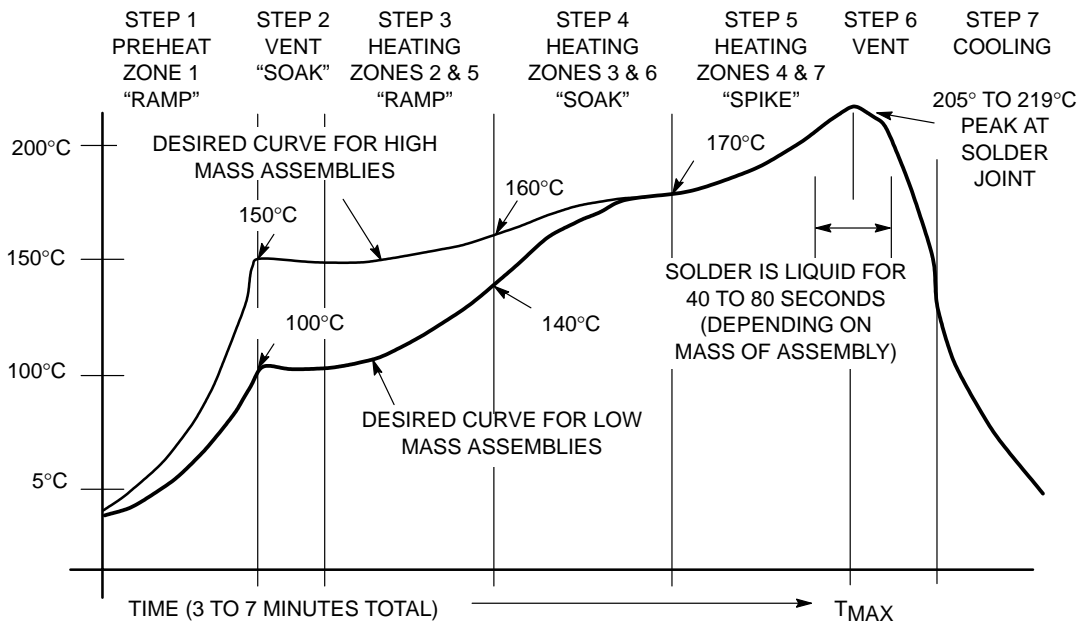
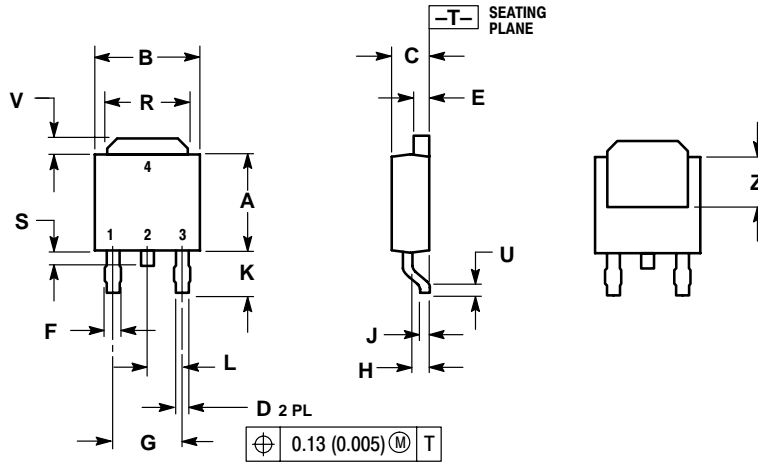

Figure 15. Typical Solder Heating Profile

NTD4302

PACKAGE DIMENSIONS

DPAK
CASE 369A-13
ISSUE AB



NOTES:

1. DIMENSIONING AND TOLERANCING PER ANSI Y14.5M, 1982.
2. CONTROLLING DIMENSION: INCH.

DIM	INCHES		MILLIMETERS	
	MIN	MAX	MIN	MAX
A	0.235	0.250	5.97	6.35
B	0.250	0.265	6.35	6.73
C	0.086	0.094	2.19	2.38
D	0.027	0.035	0.69	0.88
E	0.033	0.040	0.84	1.01
F	0.037	0.047	0.94	1.19
G	0.180 BSC		4.58 BSC	
H	0.034	0.040	0.87	1.01
J	0.018	0.023	0.46	0.58
K	0.102	0.114	2.60	2.89
L	0.090 BSC		2.29 BSC	
R	0.175	0.215	4.45	5.46
S	0.020	0.050	0.51	1.27
U	0.020	---	0.51	---
V	0.030	0.050	0.77	1.27
Z	0.138	---	3.51	---

STYLE 2:

- PIN 1. GATE
- 2. DRAIN
- 3. SOURCE
- 4. DRAIN

NTD4302

PACKAGE DIMENSIONS

DPAK
CASE 369-07
ISSUE M

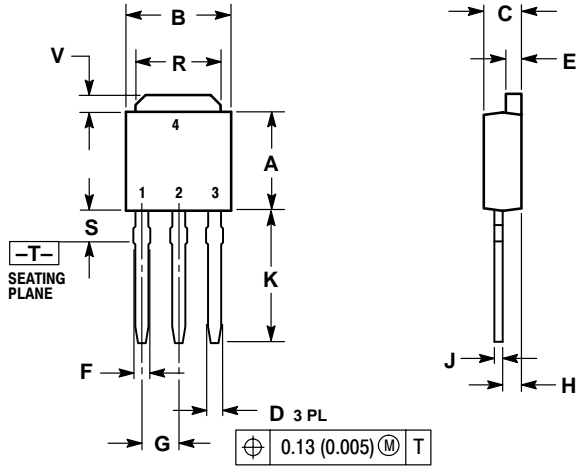

- NOTES:
1. DIMENSIONING AND TOLERANCING PER ANSI Y14.5M, 1982.
2. CONTROLLING DIMENSION: INCH.

DIM	INCHES		MILLIMETERS	
	MIN	MAX	MIN	MAX
A	0.235	0.250	5.97	6.35
B	0.250	0.265	6.35	6.73
C	0.086	0.094	2.19	2.38
D	0.027	0.035	0.69	0.88
E	0.033	0.040	0.84	1.01
F	0.037	0.047	0.94	1.19
G	0.090 BSC		2.29 BSC	
H	0.034	0.040	0.87	1.01
J	0.018	0.023	0.46	0.58
K	0.350	0.380	8.89	9.65
R	0.175	0.215	4.45	5.46
S	0.050	0.090	1.27	2.28
V	0.030	0.050	0.77	1.27

- STYLE 2:
PIN 1. GATE
2. DRAIN
3. SOURCE
4. DRAIN

Notes

ON Semiconductor and  are trademarks of Semiconductor Components Industries, LLC (SCILLC). SCILLC reserves the right to make changes without further notice to any products herein. SCILLC makes no warranty, representation or guarantee regarding the suitability of its products for any particular purpose, nor does SCILLC assume any liability arising out of the application or use of any product or circuit, and specifically disclaims any and all liability, including without limitation special, consequential or incidental damages. "Typical" parameters which may be provided in SCILLC data sheets and/or specifications can and do vary in different applications and actual performance may vary over time. All operating parameters, including "Typicals" must be validated for each customer application by customer's technical experts. SCILLC does not convey any license under its patent rights nor the rights of others. SCILLC products are not designed, intended, or authorized for use as components in systems intended for surgical implant into the body, or other applications intended to support or sustain life, or for any other application in which the failure of the SCILLC product could create a situation where personal injury or death may occur. Should Buyer purchase or use SCILLC products for any such unintended or unauthorized application, Buyer shall indemnify and hold SCILLC and its officers, employees, subsidiaries, affiliates, and distributors harmless against all claims, costs, damages, and expenses, and reasonable attorney fees arising out of, directly or indirectly, any claim of personal injury or death associated with such unintended or unauthorized use, even if such claim alleges that SCILLC was negligent regarding the design or manufacture of the part. SCILLC is an Equal Opportunity/Affirmative Action Employer.

PUBLICATION ORDERING INFORMATION

Literature Fulfillment:

Literature Distribution Center for ON Semiconductor
P.O. Box 5163, Denver, Colorado 80217 USA
Phone: 303-675-2175 or 800-344-3860 Toll Free USA/Canada
Fax: 303-675-2176 or 800-344-3867 Toll Free USA/Canada
Email: ONlit@hibbertco.com

N. American Technical Support: 800-282-9855 Toll Free USA/Canada

JAPAN: ON Semiconductor, Japan Customer Focus Center
4-32-1 Nishi-Gotanda, Shinagawa-ku, Tokyo, Japan 141-0031
Phone: 81-3-5740-2700
Email: r14525@onsemi.com

ON Semiconductor Website: <http://onsemi.com>

For additional information, please contact your local Sales Representative.



This datasheet has been download from:

www.datasheetcatalog.com

Datasheets for electronics components.