

中型钮子开关

Medium Toggle Switch

型号(TYPE): 5020

技术特性 (Specification)

1. 规格 (Rating): 15A 125V AC; 10A 250V AC
2. 接触电阻 (Contact R): 50mΩ max
3. 绝缘电阻 (Insulation R): 500V DC 1000MΩ min
4. 耐电压 (Dielectric Strength): 1 Minute 1500V AC
5. 操作温度 (Operating Temperature): -25°C ~ +85°C
6. 电气寿命 (Electrical Life): 10, 000 Cycles

外型图 (Outline Drawing)

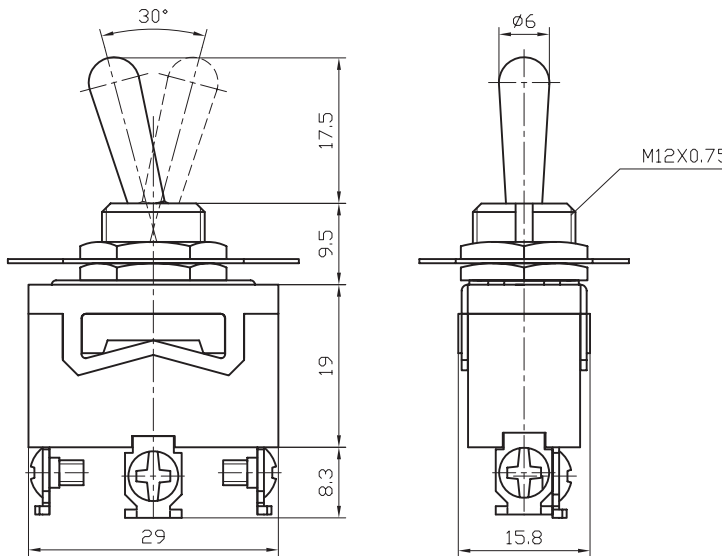

安装尺寸 (Mounting)

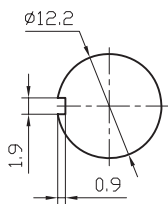

电路图 (Circuitry)

