



ISO9001-2000 APPROVED

Cabinet Solderless Breadboard



021-002-113

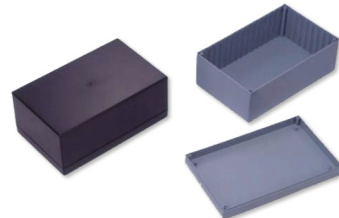

021-002-143

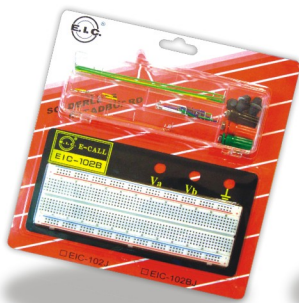

EIC-102BJ

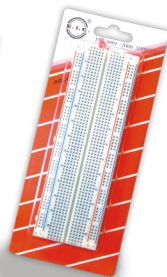

EIC-102



EIC-106J



EIC-104

E - CALL ENTERPRISE CO., LTD.
E-Mail: ecall@seed.net.tw
[Http://www.ecall-elec.com.tw](http://www.ecall-elec.com.tw)



Company Profile

About E-Call ...

- Established since 1985
- Registered as Exporter and Manufacturer
- Capital: NTD20,000,000-
- ISO 9001-2000 approved
- Employees: 30 persons
- Office & Manufacturing facilities: 1000m²

About E-Line...(E-Call in Shanghai)

- Established on July 17, 2001
- Capital: USD700,000-
- Employees: 150 persons at present
- Office & Manufacturing facilities: 2000m²

Main Products...

- Solderless breadboards and accessories (E.I.C. logo)
- Metal Keypad assembly
- Hi-Rel IC sockets and PGA sockets
- Wire harness and flat cable assembly

China patent certificate

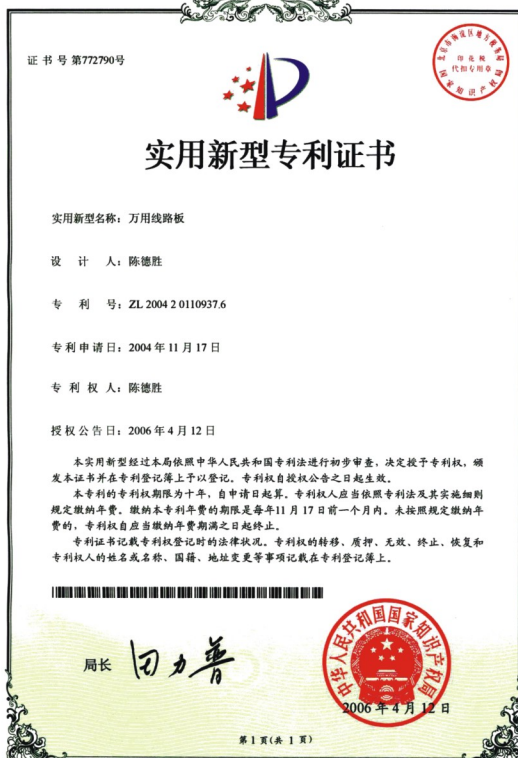

Patent No. : ZL 2004 2 0110937. 6



Patent No. : ZL 2004 3 0106004.5



Patent No. : ZL 02 347714.8



SOLDERLESS BREADBOARD: ABS PLASTIC/ SQUARE HOLE

Body material : EIC Brand, ABS plastic

Surface : Colored printing

Heat distortion temperature : 84°C

Plate material : Metal

Surface : Black

RoHS Option

Spring clip contact : Phosphor Bronze

Finish : Nickel plated

Contact life : 50,000 times

Insertion range : 0.4~0.7mm diameter

E.I.C. blister card package

Combines additional boards for larger breadboard available

OEM & Own design is welcome

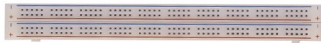

EIC-DN(2PCS/SET)



EIC-TN

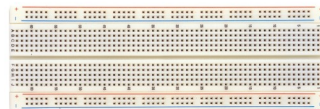

EIC-102

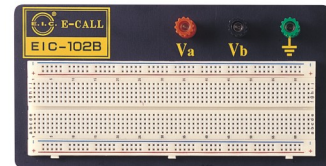

EIC-102B

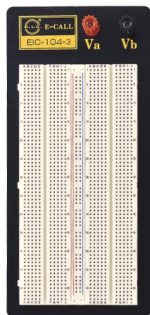

EIC-104-3

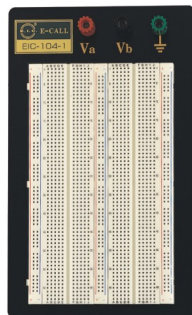

EIC-104-1

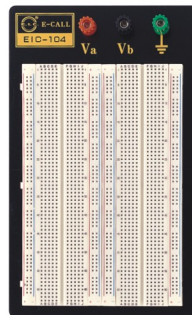

EIC-104

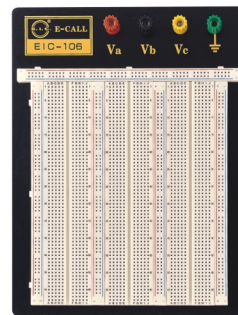

EIC-106

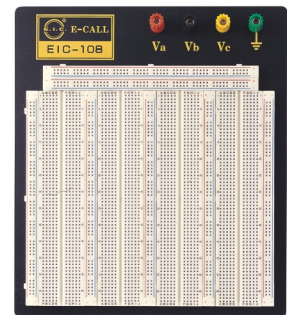

EIC-108

| Item no. | Tie-point | <u>Terminal strips</u> Terminal holes | <u>Distribution strips</u> Distribution holes | Binding posts | Foot pads | Jumper wires | Dimension(mm) (Tolerance: ±0.2mm) |
|--------------------------------|-----------|--|--|---------------|-----------|-----------------|--|
| EIC-DN | 100*2/set | 0 | $\frac{2}{200}$ | 0 | 0 | 0 | Board:165.1*18.8*8.5 |
| EIC-TN | 630 | $\frac{1}{630}$ | 0 | 0 | 0 | 0 | Board:165.1*35.5*8.5 |
| <u>EIC-102</u> EIC-102J | 830 | $\frac{1}{630}$ | $\frac{2}{200}$ | 0 | 0 | $\frac{0}{70}$ | Board:165.1*54.6*8.5 Plate:164*52*0.3 |
| <u>EIC-102B</u> EIC-102BJ | 830 | $\frac{1}{630}$ | $\frac{2}{200}$ | 3 | 5 | $\frac{0}{70}$ | Board:165.1*54.6*8.5 Plate:183*95*0.8 |
| <u>EIC-104-3</u> EIC-104-3J | 1360 | $\frac{2}{1260}$ | $\frac{1}{100}$ | 2 | 5 | $\frac{0}{70}$ | Board:165.1*80.8*8.5 Plate:215*100*0.8 |
| <u>EIC-104-1</u> EIC-104-1J | 1560 | $\frac{2}{1260}$ | $\frac{3}{300}$ | 3 | 5 | $\frac{0}{70}$ | Board:165.1*99.7*8.5 Plate:215*130*0.8 |
| <u>EIC-104</u> EIC-104J | 1660 | $\frac{2}{1260}$ | $\frac{4}{400}$ | 3 | 5 | $\frac{0}{70}$ | Board:165.1*109.3*8.5 Plate:215*130*0.8 |
| <u>EIC-106</u> EIC-106J | 2390 | $\frac{3}{1890}$ | $\frac{5}{500}$ | 4 | 5 | $\frac{0}{140}$ | Board:174.8*165.1*8.5 Plate:230*175*0.8 |
| <u>EIC-108</u> EIC-108J | 3220 | $\frac{4}{2520}$ | $\frac{7}{700}$ | 4 | 5 | $\frac{0}{140}$ | Board:184.4*190*8.5 Plate:240*240*0.8 |

SOLDERLESS BREADBOARD: POM(SILICONE) PLASTIC

Body material : EIC Brand, POM (Silicone) plastic

Surface : Blue Color

Heat distortion temperature : 150°C

Plate material : Metal

Surface : Black

RoHS Option

Spring clip contact : Phosphor Bronze

Finish : Nickel plated

Contact life : 50,000 times

Insertion range : 0.4~0.7mm diameter

E.I.C. blister card package

Combines additional boards for larger breadboard available

OEM & Own design is welcome



EIC-0210(2PCS/SET)



EIC-0220



EIC-202



EIC-202B



EIC-204-3

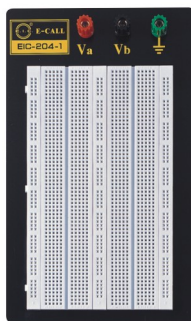

EIC-204-1

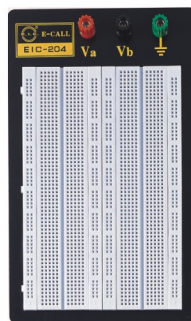

EIC-204

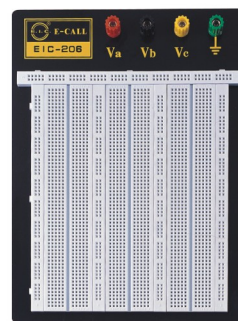

EIC-206

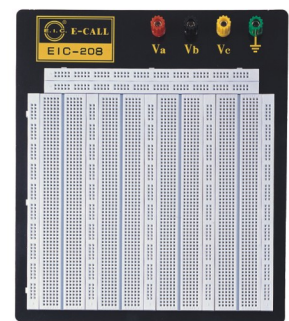

EIC-208

| Item no. | Tie-point | <u>Terminal strips</u> Terminal holes | <u>Distribution strips</u> Distribution holes | Binding posts | Foot pads | Dimension(mm) (Tolerance: ±0.2mm) |
|--------------------------------|-----------|--|--|---------------|-----------|--|
| EIC-0210 | 100*2/set | 0 | $\frac{2}{200}$ | 0 | 0 | Board:165.1*18.8*8.5 |
| EIC-0220 | 630 | $\frac{1}{630}$ | 0 | 0 | 0 | Board:165.1*35.5*8.5 |
| <u>EIC-202</u> EIC-202J | 830 | $\frac{1}{630}$ | $\frac{2}{200}$ | 0 | 0 | Board:165.1*54.6*8.5 Plate:164*52*0.3 |
| <u>EIC-202B</u> EIC-202BJ | 830 | $\frac{1}{630}$ | $\frac{2}{200}$ | 3 | 5 | Board:165.1*54.6*8.5 Plate:183*95*0.8 |
| <u>EIC-204-3</u> EIC-204-3J | 1360 | $\frac{2}{1260}$ | $\frac{1}{100}$ | 2 | 5 | Board:165.1*80.8*8.5 Plate:215*100*0.8 |
| <u>EIC-204-1</u> EIC-204-1J | 1560 | $\frac{2}{1260}$ | $\frac{3}{300}$ | 3 | 5 | Board:165.1*99.7*8.5 Plate:215*130*0.8 |
| <u>EIC-204</u> EIC-204J | 1660 | $\frac{2}{1260}$ | $\frac{4}{400}$ | 3 | 5 | Board:165.1*109.3*8.5 Plate:215*130*0.8 |
| <u>EIC-206</u> EIC-206J | 2390 | $\frac{3}{1890}$ | $\frac{5}{500}$ | 4 | 5 | Board:174.8*165.1*8.5 Plate:230*175*0.8 |
| <u>EIC-208</u> EIC-208J | 3220 | $\frac{4}{2520}$ | $\frac{7}{700}$ | 4 | 5 | Board:184.4*190*8.5 Plate:240*210*0.8 |

SOLDERLESS BREADBOARD: ABS PLASTIC

Body material : EIC Brand, ABS plastic

Surface : Unprinted

Heat distortion temperature : 84°C

Plate material : Metal

Surface : Black

RoHS Option

Spring clip contact : Phosphor Bronze

Finish : Nickel plated

Contact life : 50,000 times

Insertion range : 0.4~0.7mm diameter

E.I.C. blister card package

Combines additional boards for larger breadboard available

OEM & Own design is welcome

China Patent NO.: ZL 02 347714 .8

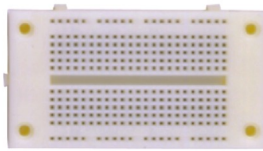

EIC-301

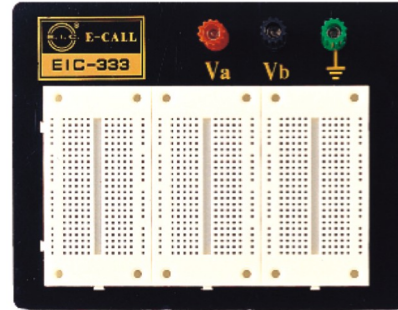

EIC-333

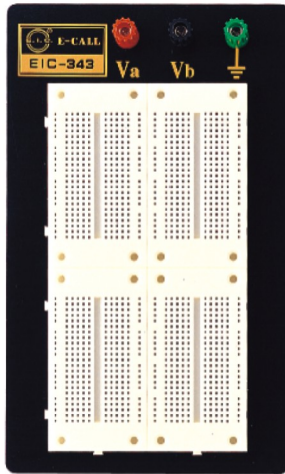

EIC-343

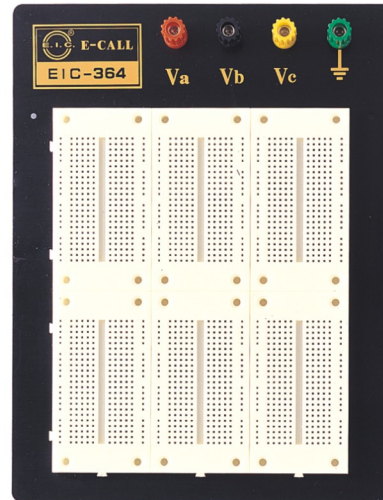

EIC-364

| Item no. | Tie-point | <u>Terminal strips</u> Terminal holes | <u>Distribution strips</u> Distribution holes | Binding posts | Foot pads | Jumper wires | Dimension(mm) (Tolerance: ±0.2mm) |
|----------|-----------|--|--|---------------|-----------|--------------|--|
| EIC-301 | 270 | 0 | 0 | 0 | 0 | 0 | Board: 83.7*45.2*8.5 |
| EIC-333 | 810 | $\frac{3}{810}$ | 0 | 3 | 5 | 0 | Board: 83.7*135.6*8.5 Plate: 165*130*0.8 |
| EIC-343 | 1080 | $\frac{4}{1080}$ | 0 | 3 | 5 | 0 | Board: 167.4*90.4*8.5 Plate: 215*130*0.8 |
| EIC-364 | 1620 | $\frac{6}{1620}$ | 0 | 4 | 5 | 0 | Board: 135.6*167.4*8.5 Plate: 230*175*0.8 |

SOLDERLESS BREADBOARD: SQUARE HOLE

Body material : EIC Brand, ABS plastic

Surface : Colored printing

Heat distortion temperature : 84°C

Plate material : Metal

Surface : Black

RoHS Option

Spring clip contact : Phosphor Bronze

Finish : Nickel plated

Contact life : 50,000 times

Insertion range : 0.4~0.7mm diameter

E.I.C. blister card package

Combines additional boards for larger breadboard available

OEM & Own design is welcome

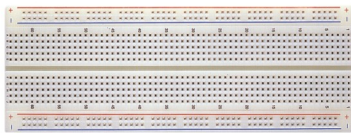

EIC-402

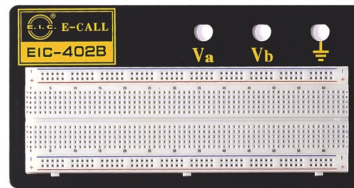

EIC-402B

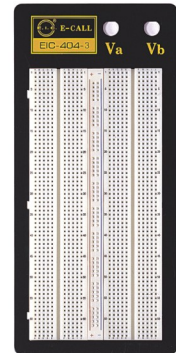

EIC-404-3

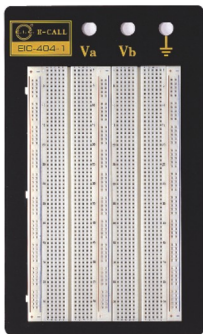

EIC-404-1

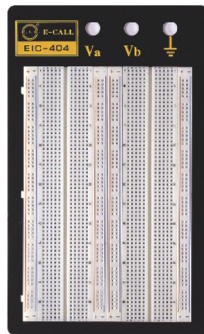

EIC-404

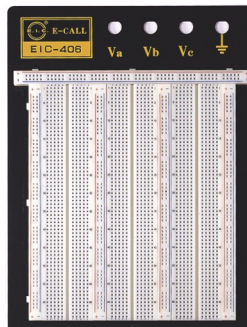

EIC-406

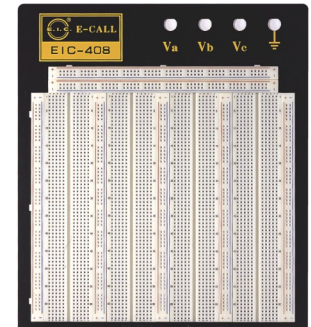

EIC-408

| Item no. | Tie-point | Terminal strips | Distribution strips | Binding posts | Foot pads | Jumper wires | Dimension(mm) (Tolerance: ±0.2mm) |
|--------------------------------|-----------|------------------|---------------------|---------------|-----------|-----------------|--|
| | | Terminal holes | Distribution holes | | | | |
| <u>EIC-402</u> EIC-402J | 840 | <u>1</u> 640 | <u>2</u> 200 | 0 | 0 | <u>0</u> 70 | Board:165.1*54.6*8.5 Plate:164*52*0.3 |
| <u>EIC-402B</u> EIC-402BJ | | <u>1</u> 640 | <u>2</u> 200 | | | 3 | 5 |
| <u>EIC-404-3</u> EIC-404-3J | 1380 | <u>2</u> 1280 | <u>1</u> 100 | 2 | 5 | <u>0</u> 70 | Board:165.1*80.8*8.5 Plate:215*100*0.8 |
| <u>EIC-404-1</u> EIC-404-1J | | <u>2</u> 1280 | <u>3</u> 300 | | | 3 | 5 |
| <u>EIC-404</u> EIC-404J | 1680 | <u>2</u> 1280 | <u>4</u> 400 | 3 | 5 | <u>0</u> 70 | Board:165.1*109.3*8.5 Plate:215*130*0.8 |
| <u>EIC-406</u> EIC-406J | | <u>3</u> 1920 | <u>5</u> 500 | | | 4 | 5 |
| <u>EIC-408</u> EIC-408J | 3260 | <u>4</u> 2560 | <u>7</u> 700 | 4 | 5 | <u>0</u> 140 | Board:184.4*190*8.5 Plate:240*210*0.8 |

SOLDERLESS BREADBOARD: ABS PLASTIC/ SQUARE HOLE

Body material : EIC Brand, ABS plastic

Surface : Unprinted

Heat distortion temperature : 84°C

Plate material : Metal

Surface : Black

RoHS Option

Spring clip contact : Phosphor Bronze

Finish : Nickel plated

Contact life : 50,000 times

Insertion range : 0.4~0.7mm diameter

E.I.C. blister card package

Combines additional boards for larger breadboard available

OEM & Own design is welcome

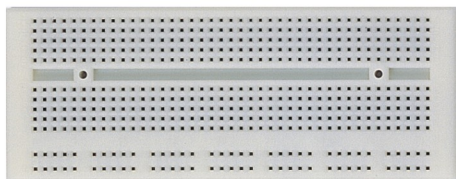

EIC-501

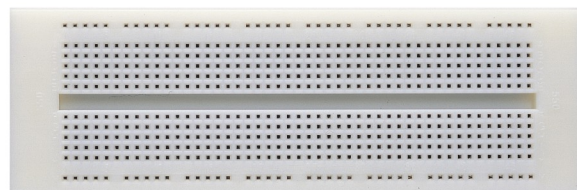

EIC-701

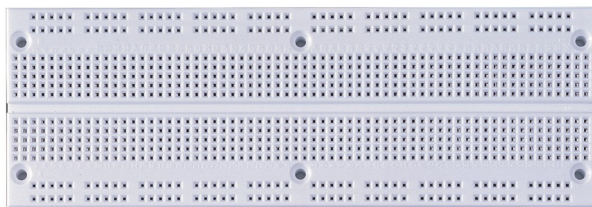

EIC-901

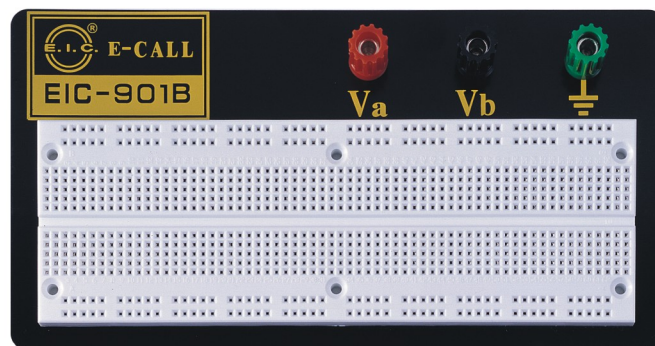

EIC-901B

| Item no. | Tie-point | <u>Terminal strips</u> Terminal holes | <u>Distribution strips</u> Distribution holes | Binding posts | Foot pads | Jumper wires | Dimension(mm) (Tolerance:±0.2mm) |
|----------|-----------|--|--|---------------|-----------|--------------|--|
| EIC-501 | 480 | $\frac{1}{480}$ | 0 | 0 | 0 | 0 | Board:117*45.2*8.5 |
| EIC-701 | 550 | $\frac{1}{550}$ | 0 | 0 | 0 | 0 | Board:144.7*46.0*8.5 |
| EIC-901 | 840 | $\frac{1}{840}$ | 0 | 0 | 0 | 0 | Board:165.1*55.8*8.5 |
| EIC-901B | 840 | $\frac{1}{840}$ | 0 | 3 | 5 | 0 | Board:165.1*55.8*8.5 Plate:183.0*95.0*0.8 |

SOLDERLESS BREADBOARD: ABS PLASTIC/ SQUARE HOLE

Body material : EIC Brand, ABS plastic

Surface : Colored printing

Heat distortion temperature : 84°C

Plate material : Metal

Surface : Black

RoHS Option

Spring clip contact : Phosphor Bronze

Finish : Nickel plated

Contact life : 50,000 times

Insertion range : 0.4~0.7mm diameter

E.I.C. blister card package

Combines additional boards for larger breadboard available

OEM & Own design is welcome

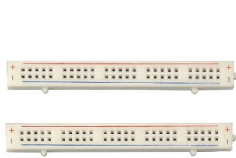

EIC-801D(2PCS/SET)

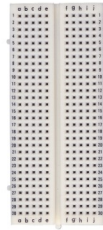

EIC-801T

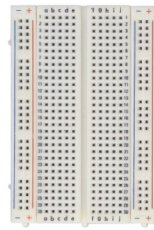

EIC-801

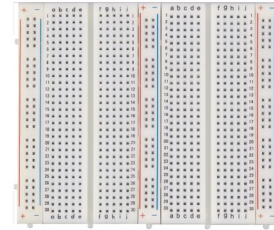

EIC-8021

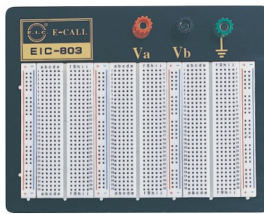

EIC-8032

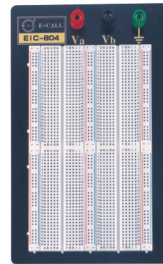

EIC-8042

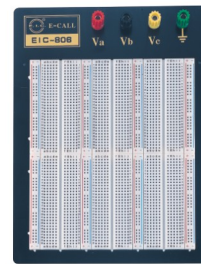

EIC-8064

| Item no. | Tie-point | $\frac{\text{Terminal strips}}{\text{Terminal holes}}$ | $\frac{\text{Distribution strips}}{\text{Distribution holes}}$ | Binding posts | Foot pads | Jumper wires | Dimension(mm) (Tolerance: $\pm 0.2\text{mm}$) |
|----------|-----------|--|--|---------------|-----------|--------------|---|
| EIC-801D | 50*2/set | 0 | $\frac{2}{100}$ | 0 | 0 | 0 | Board:84.0*9.4*8.5 |
| EIC-801T | 300 | $\frac{1}{300}$ | 0 | 0 | 0 | 0 | Board:84.0*35.5*8.5 |
| EIC-801 | 400 | $\frac{1}{300}$ | $\frac{2}{100}$ | 0 | 0 | 0 | Board:84.0*54.3*8.5 |
| EIC-8021 | 750 | $\frac{2}{600}$ | $\frac{3}{150}$ | 0 | 0 | 0 | Board:84.0*99.2*8.5 |
| EIC-8032 | 1100 | $\frac{3}{900}$ | $\frac{4}{200}$ | 3 | 5 | 0 | Board:84.0*144.1*8.5 Plate:165.0*130.0*0.8 |
| EIC-8042 | 1500 | $\frac{4}{1200}$ | $\frac{6}{300}$ | 3 | 5 | 0 | Board:168.0*99.2*8.5 Plate:215.0*130.0*0.8 |
| EIC-8064 | 2200 | $\frac{6}{1800}$ | $\frac{8}{400}$ | 4 | 5 | 0 | Board:144.1*168.0*8.5 Plate:230.0*175.0*0.8 |

SOLDERLESS BREADBOARD: ABS PLASTIC/ ROUND HOLE

Body material : EIC Brand, ABS plastic

Surface : Colored printing

Heat distortion temperature : 84°C

Plate material : Metal

Surface : Black

RoHS Option

Spring clip contact : Phosphor Bronze

Finish : Nickel plated

Contact life : 50,000 times

Insertion range : 0.4~0.7mm diameter

E.I.C. blister card package

Combines additional boards for larger breadboard available

OEM & Own design is welcome

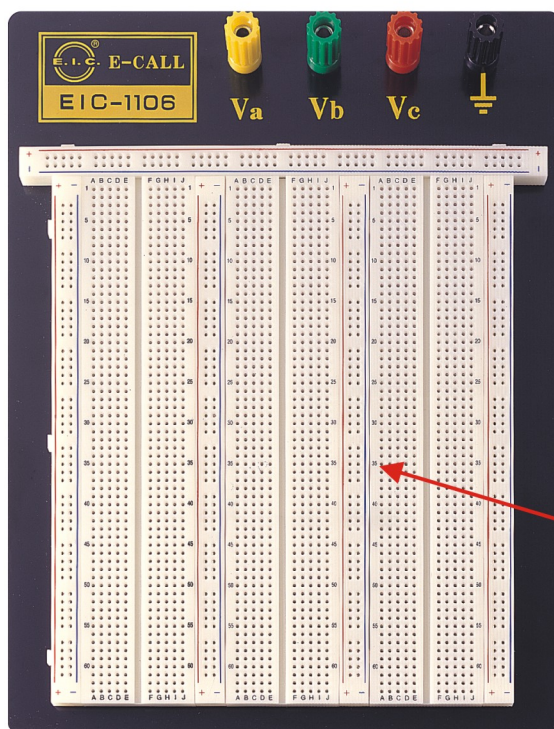

China Paten NO.: ZL 2004 3 0106004 .5
ZL 2004 2 0110937. 6

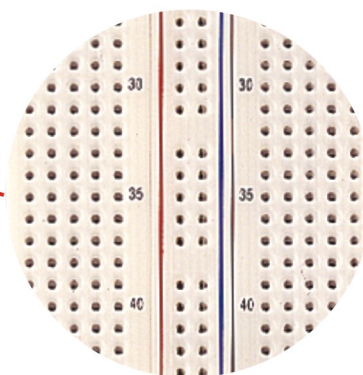

| Item no. | Tie-point | <u>Terminal strips</u> Terminal holes | <u>Distribution strips</u> Distribution holes | Binding posts | Foot pads | Jumper wires | Dimension(mm) (Tolerance: ±0.2mm) |
|----------|-----------|--|--|---------------|-----------|--------------|--|
| EIC-1102 | 830 | $\frac{1}{630}$ | $\frac{2}{200}$ | 0 | 0 | 0 | Board:165.1*54.6*8.5 Plate:164*52*0.3 |
| EIC-1104 | 1660 | $\frac{2}{1260}$ | $\frac{4}{400}$ | 3 | 5 | 0 | Board:165.1*109.3*8.5 Plate:215*130*0.8 |
| EIC-1106 | 2390 | $\frac{3}{1890}$ | $\frac{5}{500}$ | 4 | 5 | 0 | Board:174.8*165.1*8.5 Plate:230*175*0.8 |
| EIC-1108 | 3220 | $\frac{4}{2520}$ | $\frac{7}{700}$ | 4 | 5 | 0 | Board:184.4*190*8.5 Plate:240*210*0.8 |

SOLDERLESS BREADBOARD: ABS PLASTIC/SQUARE HOLE/With Terminal Blocks

Body material : EIC Brand, ABS plastic

Surface : Colored printing

Heat distortion temperature : 84°C

Plate material : Metal

Surface : Black

RoHS Option

Spring clip contact : Phosphor Bronze

Finish : Nickel plated

Contact life : 50,000 times

Insertion range : 0.4~0.7mm diameter

E.I.C. blister card package

Combines additional boards for larger breadboard available

OEM & Own design is welcome

With Terminal Blocks



EIC-1202B



EIC-1204-1B

| Item no. | Tie-point | $\frac{\text{Terminal strips}}{\text{Terminal holes}}$ | $\frac{\text{Distribution strips}}{\text{Distribution holes}}$ | Terminal Blocks | Foot pads | Jumper wires | Dimension(mm) (Tolerance: ±0.2mm) |
|-------------|-----------|--|--|-----------------|-----------|--------------|---|
| EIC-1202B | 830 | $\frac{1}{630}$ | $\frac{2}{200}$ | 2*8 | 5 | 0 | Board: 165.1*54.6*8.5 Plate: 183*95*0.8 |
| EIC-1204-1B | 1560 | $\frac{2}{1260}$ | $\frac{3}{300}$ | 2*8 | 5 | 0 | Board: 165.1*99.7*8.5 Plate: 183*160*0.8 |

New Breadboard Simple Type (Round Hole)

Easy to Combine Together

Assemble to Variety Sizes

Easy for Use

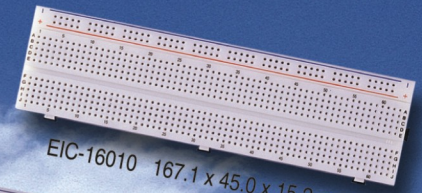

EIC-16010 167.1 x 45.0 x 15.2 mm

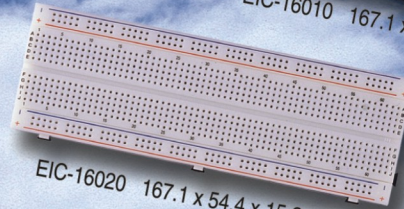

EIC-16020 167.1 x 54.4 x 15.2 mm

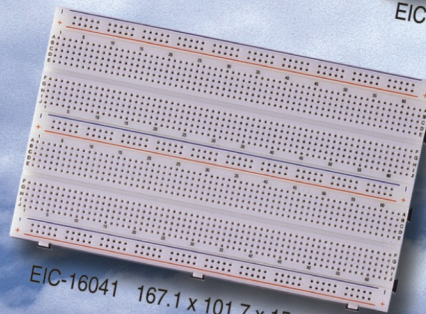

EIC-16041 167.1 x 101.7 x 15.2 mm

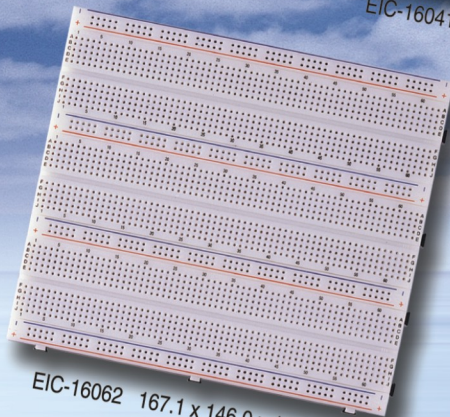

EIC-16062 167.1 x 146.0 x 15.2 mm

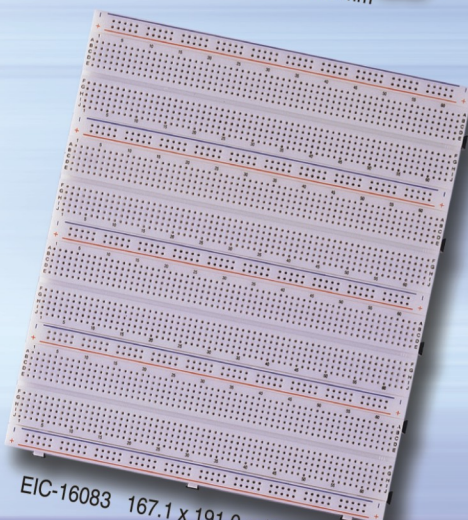

EIC-16083 167.1 x 191.0 x 15.2 mm

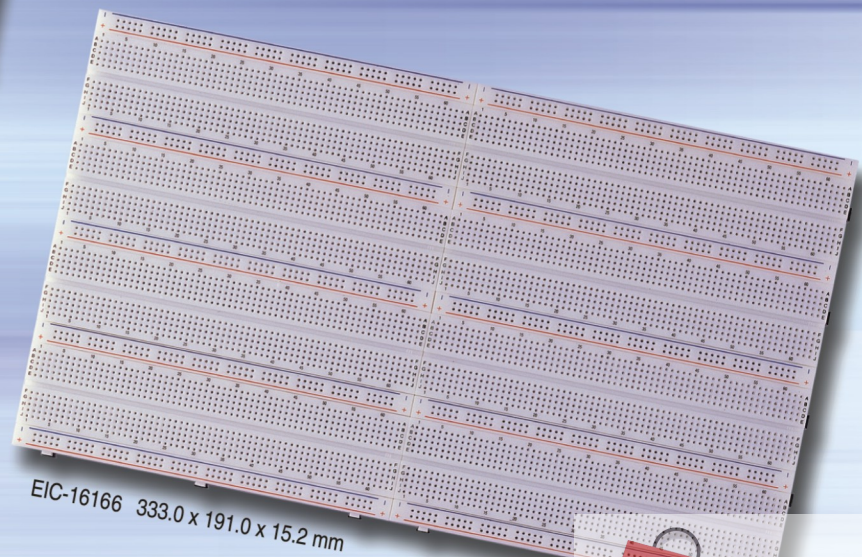

EIC-16166 333.0 x 191.0 x 15.2 mm



SOLDERLESS BREADBOARD : EIC-15010/EIC-602/605

Body material : EIC Brand, POM plastic

Surface : Unprinted

Heat distortion temperature : 150°C

Terminalholes : 170 holes

RoHS Option

Spring clip contact : Phosphor Bronze

Finish : Nickel plated

Contact life : 50,000 times

Insertion range : 0.4~0.7mm diameter

E.I.C. blister card package

Combines additional boards for larger breadboard available

OEM & Own design is welcome

****With 2pcs screws**

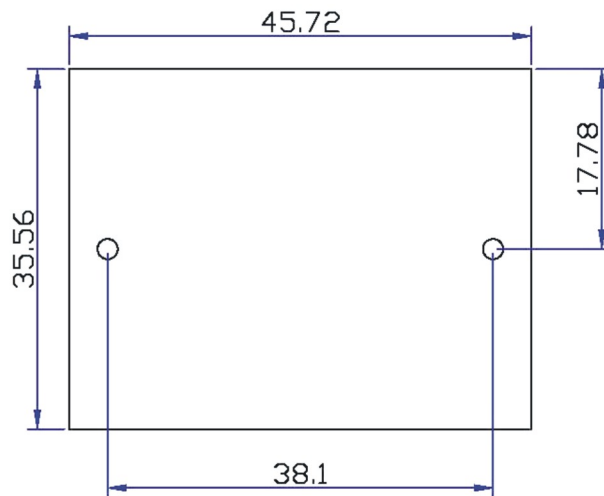
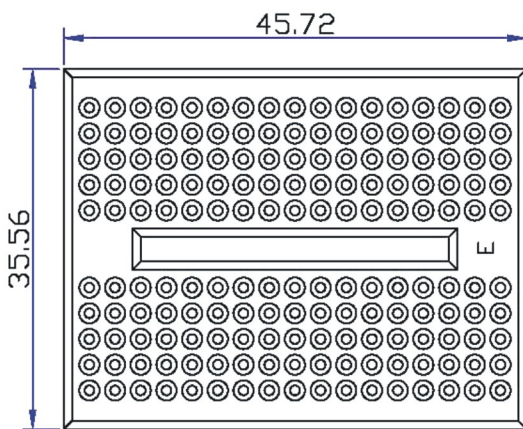
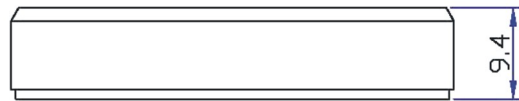
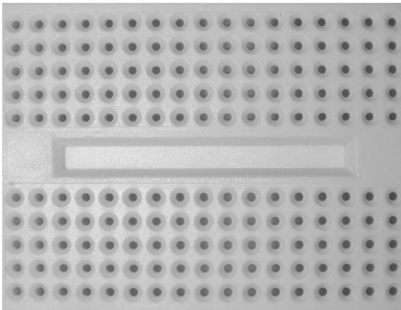

TERMINAL BLOCK

*L.E.D. indicators not included

*Polybag pack

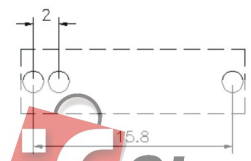
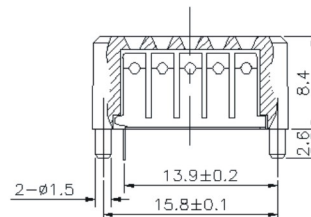
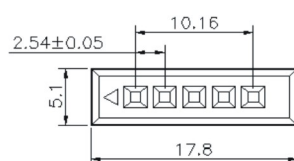
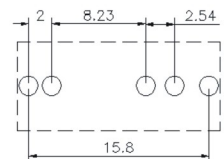
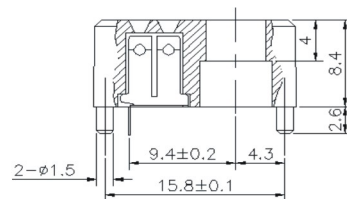
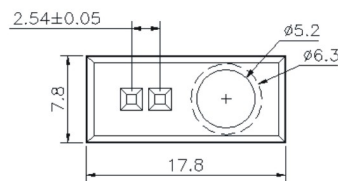

JUMPER WIRE KIT

A perfect kit contains 14 sizes of colorful solid 22 AWG wire jumpers

Each jumper with stripped and right-angled ends for easy use for breadboards

Supplied in an excellent plastic case for well-assortment

RoHS Option



EIC-J-XL(350pcs)

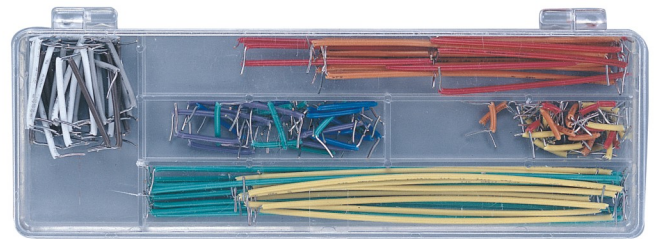

EIC-J-L(140pcs)

EIC-J-S(70pcs)

22 AWG solid wires

Pre-cut, Pre Stripped and Preformed on each end.

Variety colors, 14 lengths (2.5/5.1/7.7/10.3/12.7/15.3/17.8/20.1/22.8/25.4/51.3/76.3/101.3 and 126.3mm) ± 0.2mm

Completely Reusable

| Item no. | Description | Box (mm) |
|----------|---|-----------------------------------|
| EIC-J-XL | 350pcs jumper wires (14 lengths x 25pcs each) | 205x145x40 (Item no. 021-002-350) |
| EIC-J-L | 140pcs jumper wires (14 lengths x 10pcs each) | 168x55.5x14.5 |
| EIC-J-S | 70pcs jumper wires (14 lengths x 5pcs each) | 168x55.5x14.5 |

CABINET

Box will not crack or split when drilled or punched, enclosed with four screws and lid

Material by ABS plastic in foggy surface

Anti-static/RoHS option

Standard Color: Black Optional Color: Gray, Beige

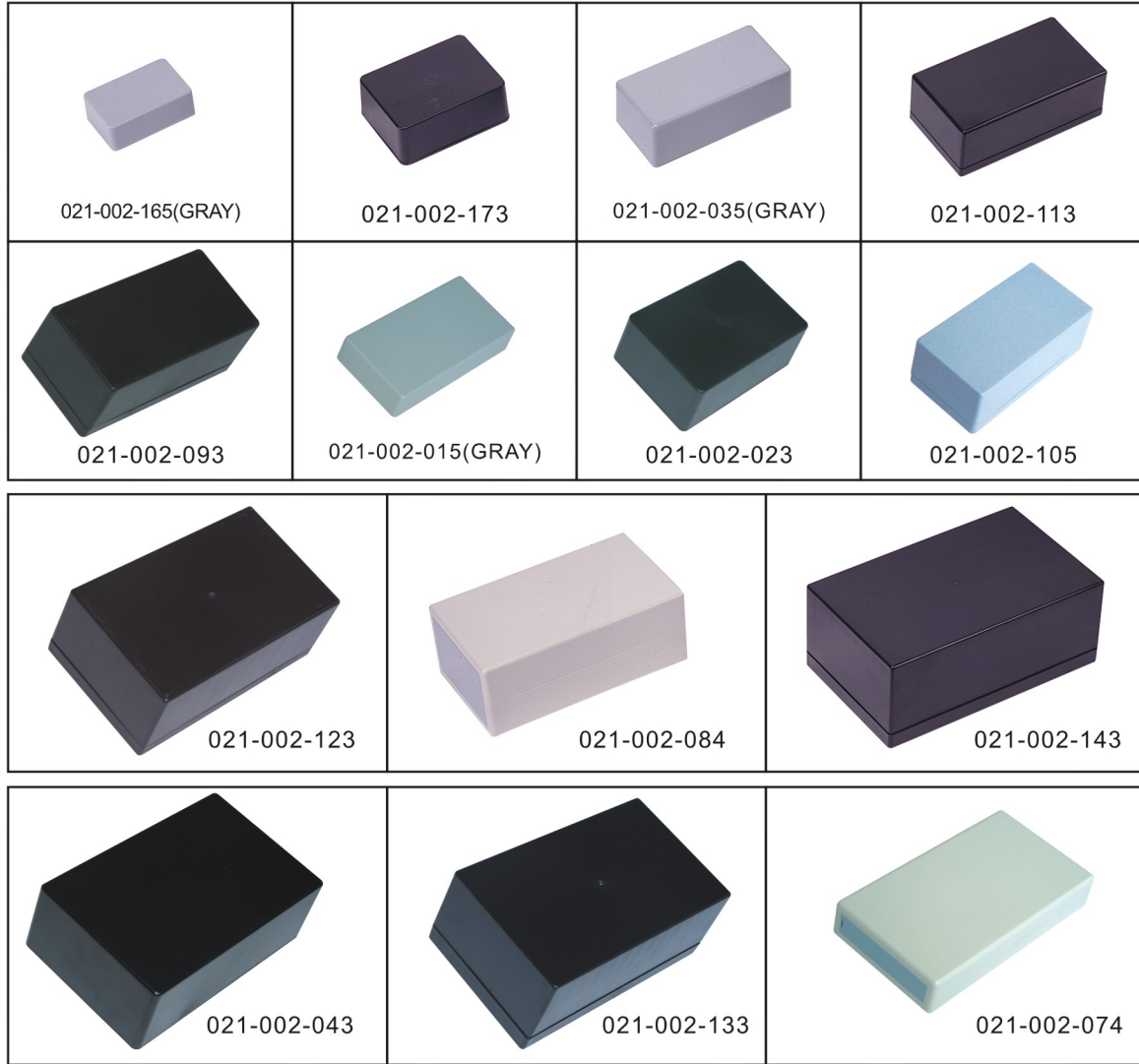

| Item no. | Box description (mm) (Tolerance: ±0.2mm) | Item no. | Box description (mm) (Tolerance: ±0.2mm) |
|-------------|---|-------------|---|
| 021-002-013 | 112mm*57mm*22mm/ BLACK | 021-002-103 | 115mm*60mm*44mm/ BLACK |
| 021-002-023 | 150mm*99mm*60mm/ BLACK | 021-002-113 | 135mm*75mm*49mm/ BLACK |
| 021-002-033 | 129mm*64mm*45mm/ BLACK | 021-002-123 | 160mm*95mm*62mm/ BLACK |
| 021-002-043 | 185mm*114mm*66mm/ BLACK | 021-002-133 | 193mm*115mm*75mm/ BLACK |
| 021-002-074 | 196mm*110mm*36mm/ GRAY+BEIGE | 021-002-143 | 223mm*139mm*92mm / BLACK |
| 021-002-084 | 195mm*110mm*76mm/ GRAY+BEIGE | 021-002-163 | 76mm*50mm*27mm/BLACK |
| 021-002-093 | 95mm*48mm*37mm/ BLACK | 021-002-173 | 102mm*77mm*41mm/BLACK |

Transparent Solderless Breadboard

全新 透明免焊型麵包板

獨家透明設計 (New Transparent Look)

高級ABS材質，不易變形 (High quality ABS material)

結構清晰，元件插拔一目瞭然 (Clear view of the structure)

億舟 24 YEAR

另通過中國專利証號
ZL 2004 3 0106004.5

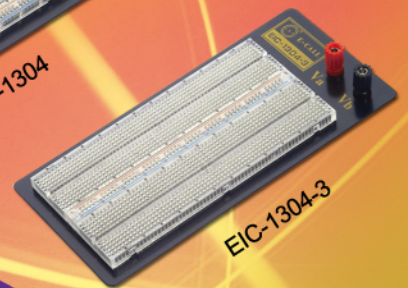
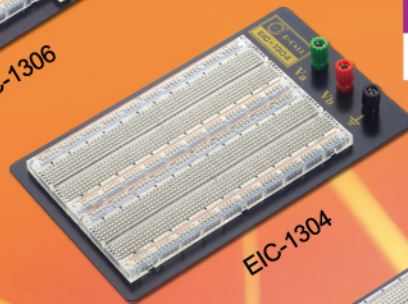
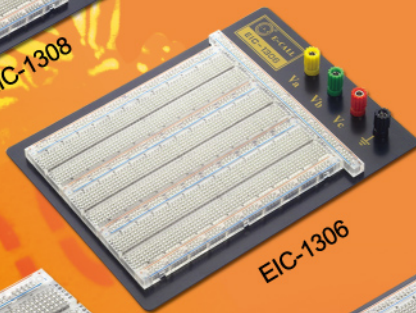
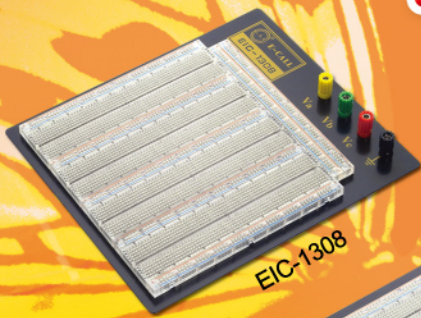

Machine Pin Jumper Wires

- 圓型車床針更易插拔，重覆使用不變形 (Round machine pin/Easy for insertion, extraction/ No distortion)
- 線體有彈性，可彎折使用仍恢復原狀 (Flexible wires)



0116-719-06-005
(50mm)



0116-719-08-007
(70mm)



0116-719-07-010
(100mm)



0116-719-11-015
(150mm)



0116-719-02-020
(200mm)



億舟企業股份有限公司
台北市南港區重陽路221號6F
TEL:886-2-2788-9688 (代表號)
<http://www.ecall-elec.com.tw>

E-CALL ENTERPRISE CO., LTD.
FAX:886-2-26511996, 26514606
E-mail:ecall@seed.net.tw



特殊型麵包板

另通過中國專利証號 ZL 2004 3 0106004.5



SOLDER:165-4015-2-200DN

SOLDER:165-4014-2-23010

SOLDER:165-4014-2-21010

億舟 24 YEAR

SOLDER:
165-4014-2-25010

SOLDER:
165-4014-2-22010

SOLDER:
165-4014-2-24010

★ 165-40-1-180DN
104.14x9.4x8.5mm

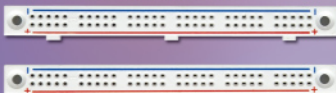

★ 165-40-1-190DN
134.62x9.4x8.5mm



★ 165-40-1-200DN
165.1x9.4x8.5mm



★ 165-40-1-180TN
104.14x35.6x8.5mm

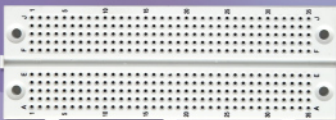

★ 165-40-1-190TN
134.62x35.6x8.5mm

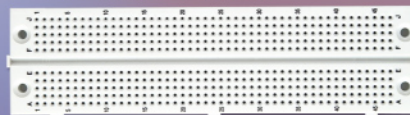

★ 165-40-1-200TN
165.1x35.6x8.5mm

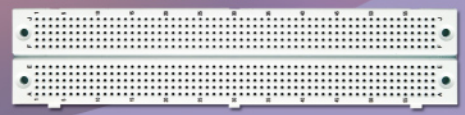

億舟企業股份有限公司
台北市南港區重陽路221號6F
TEL:886-2-2788-9688 (代表號)
<http://www.ecall-elec.com.tw>

E-CALL ENTERPRISE CO., LTD.
FAX:886-2-26511996, 26514606
E-mail:ecall@seed.net.tw



免焊型麵包板 特殊尺寸

億舟 25 YEAR



EIC-2006

另通過中國專利証號 ZL 2004 3 0106004.5



EIC-2008

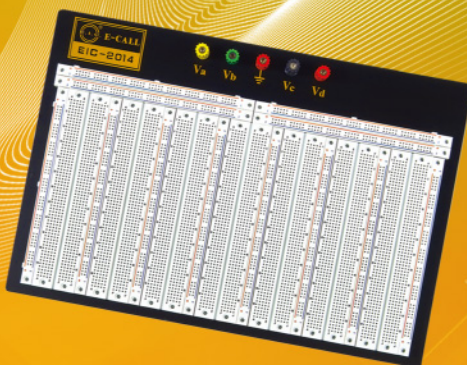

EIC-2014

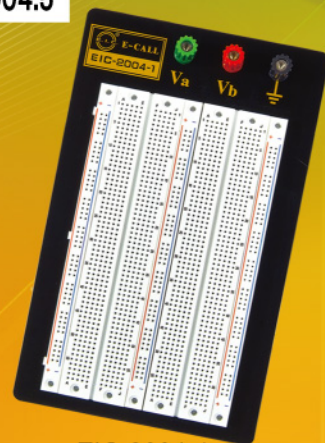

EIC-2004-1

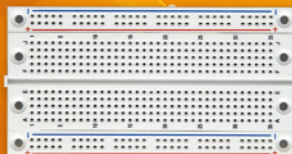

● 165-40-1-18020
104.1x54.4x9.4mm

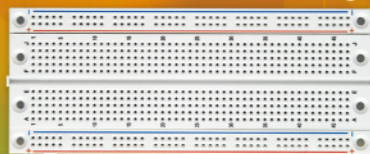

● 165-40-1-19020
134.6x54.4x9.4mm

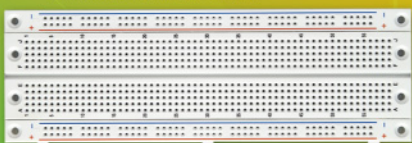

● 165-40-1-20020
165.1x54.4x9.4mm

● Jumper Wires: M-M (Machine Pin) / M-F / F-F
(50mm/70mm/100mm/150mm/200mm, variety colors)
10pcs/pack



0116-719-07-010
(100mm, M-M, Orange)



0116-71905-01-015
(150mm, F-F, Red)



0116-71904-11-015
(150mm, M-F, Purple)



億舟企業股份有限公司
台北市南港區重陽路221號6F
TEL: 886-2-2788-9688 (代表號)
http://www.ecall-elec.com.tw

E-CALL ENTERPRISE CO., LTD.
FAX: 886-2-26511996, 26514606
E-mail: ecall@seed.net.tw





SOLDERLESS BREADBOARD

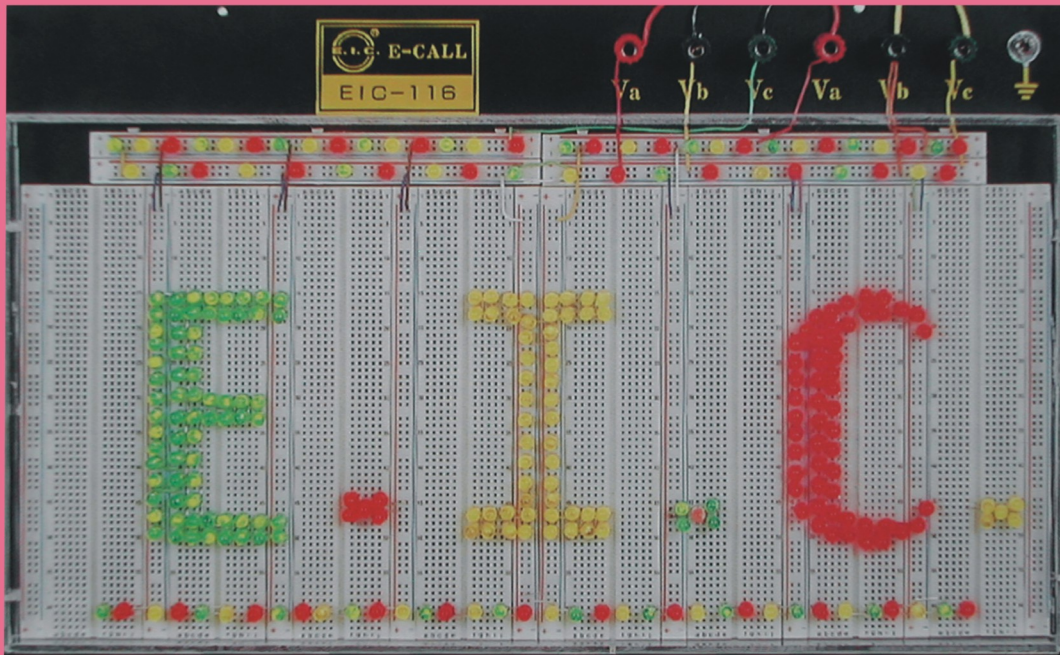

HEADQUARTER

E-CALL Enterprise Co.,Ltd.
6FL, NO. 221, CHUNG YUNG RD.,
NAN KANG DIST. 11563 TAIPEI, TAIWAN.
Tel:886-2-27889688(REP.)
Fax:886-2-26511996,26514606
E-mail:ecall@seed.net.tw

FACTORY

E-LINE Electronics Shanghai Co.,Ltd.
BUILDING NO. 1, NO. 1955, CHUN SHEN ROAD,
SHANGHAI, CITY, CHINA 200237
Tel:86-21-54300271,54300272,54300273
Fax:86-21-54300279
E-mail:e-line_sh@163.com

[Http://www.ecall-elec.com.tw](http://www.ecall-elec.com.tw)

